



Configuring MSTP

This chapter describes how to configure the Cisco implementation of the IEEE 802.1s Multiple STP (MSTP) on your Catalyst 3550 switch.



Note

The multiple spanning-tree (MST) implementation in Cisco IOS Release 12.2(25)SEC is based on the IEEE 802.1s standard. The MST implementations in earlier Cisco IOS releases are prestandard.

The MSTP enables multiple VLANs to be mapped to the same spanning-tree instance, reducing the number of spanning-tree instances needed to support a large number of VLANs. The MSTP provides for multiple forwarding paths for data traffic and enables load balancing. It improves the fault tolerance of the network because a failure in one instance (forwarding path) does not affect other instances (forwarding paths). The most common initial deployment of MSTP is in the backbone and distribution layers of a Layer 2 switched network. This deployment provides the highly available network required in a service-provider environment.

When the switch is in the MST mode, the Rapid Spanning Tree Protocol (RSTP), which is based on IEEE 802.1w, is automatically enabled. The RSTP provides rapid convergence of the spanning tree through explicit handshaking that eliminates the IEEE 802.1D forwarding delay and quickly transitions root ports and designated ports to the forwarding state.

Both MSTP and RSTP improve the spanning-tree operation and maintain backward-compatibility with equipment that is based on the (original) IEEE 802.1D spanning tree, with existing Cisco-proprietary Multiple Instance STP (MISTP) and with existing Cisco per-VLAN spanning-tree plus (PVST+) and rapid per-VLAN spanning-tree plus (rapid PVST+). For information about PVST+ and rapid PVST+, see [Chapter 15, “Configuring STP.”](#) For information about other spanning-tree features such as Port Fast, UplinkFast, root guard, and so forth, see [Chapter 17, “Configuring Optional Spanning-Tree Features.”](#)



Note

For complete syntax and usage information for the commands used in this chapter, see the command reference for this release.

This chapter consists of these sections:

- [Understanding MSTP, page 16-2](#)
- [Understanding RSTP, page 16-9](#)
- [Configuring MSTP Features, page 16-14](#)
- [Displaying the MST Configuration and Status, page 16-26](#)

Understanding MSTP

MSTP, which uses RSTP for rapid convergence, enables VLANs to be grouped into a spanning-tree instance, with each instance having a spanning-tree topology independent of other spanning-tree instances. This architecture provides multiple forwarding paths for data traffic, enables load balancing, and reduces the number of spanning-tree instances required to support a large number of VLANs.

These sections describe how the MSTP works:

- [Multiple Spanning-Tree Regions, page 16-2](#)
- [IST, CIST, and CST, page 16-3](#)
- [Hop Count, page 16-6](#)
- [Boundary Ports, page 16-6](#)
- [IEEE 802.1s Implementation, page 16-7](#)
- [Interoperability with IEEE 802.1D STP, page 16-9](#)

For configuration information, see the “[Configuring MSTP Features](#)” section on page 16-14.

Multiple Spanning-Tree Regions

For switches to participate in multiple spanning-tree (MST) instances, you must consistently configure the switches with the same MST configuration information. A collection of interconnected switches that have the same MST configuration comprises an MST region as shown in [Figure 16-1 on page 16-5](#).

The MST configuration determines to which MST region each switch belongs. The configuration includes the name of the region, the revision number, and the MST VLAN-to-instance assignment map. You configure the switch for a region by using the **spanning-tree mst configuration** global configuration command, after which the switch enters the MST configuration mode. From this mode, you can map VLANs to an MST instance by using the **instance** MST configuration command, specify the region name by using the **name** MST configuration command, and set the revision number by using the **revision** MST configuration command.

A region can have one or multiple members with the same MST configuration; each member must be capable of processing RSTP bridge protocol data units (BPDUs). There is no limit to the number of MST regions in a network, but each region can only support up to 65 spanning-tree instances. Instances can be identified by any number in the range from 0 to 4094. You can assign a VLAN to only one spanning-tree instance at a time.

IST, CIST, and CST

Unlike PVST+ and rapid PVST+ in which all the spanning-tree instances are independent, the MSTP establishes and maintains two types of spanning trees:

- An internal spanning tree (IST), which is the spanning tree that runs in an MST region.

Within each MST region, the MSTP maintains multiple spanning-tree instances. Instance 0 is a special instance for a region, known as the internal spanning tree (IST). All other MST instances are numbered from 1 to 4094.

The IST is the only spanning-tree instance that sends and receives BPDUs. All of the other spanning-tree instance information is contained in M-records, which are encapsulated within MSTP BPDUs. Because the MSTP BPDU carries information for all instances, the number of BPDUs that need to be processed to support multiple spanning-tree instances is significantly reduced.

All MST instances within the same region share the same protocol timers, but each MST instance has its own topology parameters, such as root switch ID, root path cost, and so forth. By default, all VLANs are assigned to the IST.

An MST instance is local to the region; for example, MST instance 1 in region A is independent of MST instance 1 in region B, even if regions A and B are interconnected.

- A common and internal spanning tree (CIST), which is a collection of the ISTs in each MST region, and the common spanning tree (CST) that interconnects the MST regions and single spanning trees.

The spanning tree computed in a region appears as a subtree in the CST that encompasses the entire switched domain. The CIST is formed by the spanning-tree algorithm running among switches that support the IEEE 802.1w, IEEE 802.1s and IEEE 802.1D standards. The CIST inside an MST region is the same as the CST outside a region.

For more information, see the “Operations Within an MST Region” section on page 16-3 and the “Operations Between MST Regions” section on page 16-4.



Note

The implementation of the IEEE 802.1s standard changes some of the terminology associated with MST implementations. For a summary of these changes, see [Table 16-1 on page 16-6](#)

Operations Within an MST Region

The IST connects all the MSTP switches in a region. When the IST converges, the root of the IST becomes the CIST regional root (called the *IST master* before the implementation of the IEEE 802.1s standard) as (shown in [Figure 16-1 on page 16-5](#)), if the switch is within the region with the lowest switch ID and path cost to the CIST root. The CIST regional root is also the CIST root if there is only one region within the network. If the CIST root is outside the region, one of the MSTP switches at the boundary of the region is selected as the CIST regional root.

When an MSTP switch initializes, it sends BPDUs claiming itself as the root of the CIST and the CIST regional root, with both of the path costs to the CIST root and to the CIST regional root set to zero. The switch also initializes all of its MST instances and claims to be the root for all of them. If the switch receives superior MST root information (lower switch ID, lower path cost, and so forth) than currently stored for the switch, it relinquishes its claim as the CIST regional root.

During initialization, a region might have many subregions, each with its own CIST regional root. As switches receive superior IST information, they leave their old subregions and join the new subregion that might contain the true CIST regional root. Thus all subregions shrink, except for the one that contains the true CIST regional root.

For correct operation, all switches in the MST region must agree on the same CIST regional root. Therefore, any two switches in the region only synchronize their port roles for an MST instance if they converge to a common CIST regional root.

Operations Between MST Regions

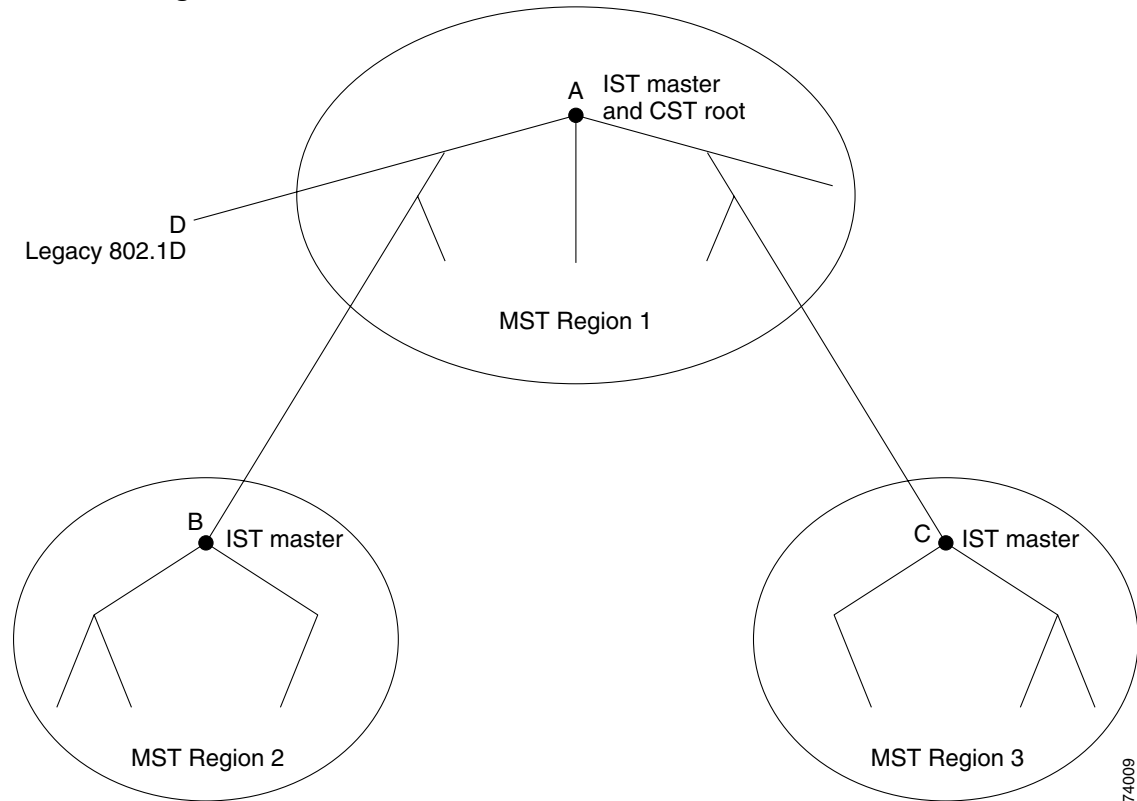

If there are multiple regions or legacy IEEE 802.1D switches within the network, MSTP establishes and maintains the CIST, which includes all MST regions and all legacy STP switches in the network. The MST instances combine with the IST at the boundary of the region to become the CIST.

The IST connects all the MSTP switches in the region and appears as a subtree in the CIST that encompasses the entire switched domain, the root of the subtree is the CIST regional root. The MST region appears as a virtual switch to adjacent STP switches and MST regions.

Figure 16-1 shows a network with three MST regions and a legacy IEEE 802.1D switch (D). The CIST regional root for region 1 (A) is also the CIST root. The CIST regional root for region 2 (B) and the CIST regional root for region 3 (C) are the roots for their respective subtrees within the CIST. The RSTP runs in all regions.

Figure 16-1 MST Regions, CIST Regional Roots, and the CST Root

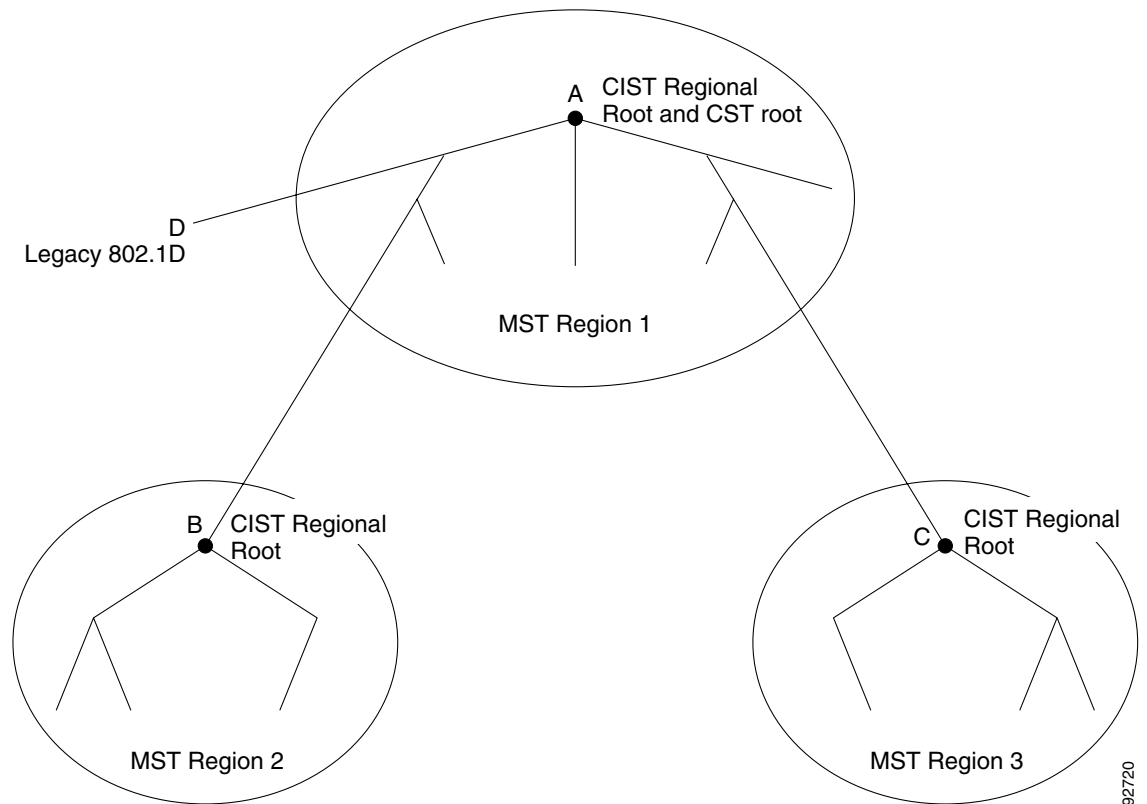

Figure 16-1 does not show additional MST instances for each region. Note that the topology of MST instances can be different from that of the IST for the same region.

Only the CST instance sends and receives BPDUs, and MST instances add their spanning-tree information into the BPDUs to interact with neighboring switches and compute the final spanning-tree topology. Because of this, the spanning-tree parameters related to BPDU transmission (for example, hello time, forward time, max-age, and max-hops) are configured only on the CST instance but affect all MST instances. Parameters related to the spanning-tree topology (for example, switch priority, port VLAN cost, and port VLAN priority) can be configured on both the CST instance and the MST instance.

MSTP switches use version 3 RSTP BPDUs or IEEE 802.1D STP BPDUs to communicate with legacy IEEE 802.1D switches. MSTP switches use MSTP BPDUs to communicate with MSTP switches.

IEEE 802.1s Terminology

Some MST naming conventions used in Cisco's prestandard implementation have been changed to identify some *internal* or *regional* parameters. These parameters are significant only within an MST region, as opposed to external parameters that are relevant to the whole network. Because the CIST is the only spanning-tree instance that spans the whole network, only the CIST parameters require the external rather than internal or regional qualifiers.

- The CIST root is the root switch for the unique instance that spans the whole network, the CIST.
- The CIST external root path cost is the cost to the CIST root. This cost is left unchanged within an MST region. Remember that an MST region looks like a single switch for the CIST. The CIST external root path cost is the root path cost calculated between these virtual switches and switches that do not belong to any region.

- The CIST regional root was called the IST master in the prestandard implementation. If the CIST root is in the region, the CIST regional root is the CIST root. Otherwise, the CIST regional root is the closest switch to the CIST root in the region. The CIST regional root acts as a root switch for the IST.
- The CIST internal root path cost is the cost to the CIST regional root in a region. This cost is only relevant to the IST, instance 0.

Table 16-1 on page 16-6 compares the IEEE standard and the Cisco prestandard terminology.

Table 16-1 Prestandard and Standard Terminology

IEEE Standard	Cisco Prestandard	Cisco Standard
CIST regional root	IST master	CIST regional root
CIST internal root path cost	IST master path cost	CIST internal path cost
CIST external root path cost	Root path cost	Root path cost
MSTI regional root	Instance root	Instance root
MSTI Internal root path cost	Root path cost	Root path cost

Hop Count

The IST and MST instances do not use the message-age and maximum-age information in the configuration BPDU to compute the spanning-tree topology. Instead, they use the path cost to the root and a hop-count mechanism similar to the IP time-to-live (TTL) mechanism.

By using the **spanning-tree mst max-hops** global configuration command, you can configure the maximum hops inside the region and apply it to the IST and all MST instances in that region. The hop count achieves the same result as the message-age information (determines when to trigger a reconfiguration). The root switch of the instance always sends a BPDU (or M-record) with a cost of 0 and the hop count set to the maximum value. When a switch receives this BPDU, it decrements the received remaining hop count by one and propagates this value as the remaining hop count in the BPDUs it generates. When the count reaches zero, the switch discards the BPDU and ages the information held for the port.

The message-age and maximum-age information in the RSTP portion of the BPDU remain the same throughout the region, and the same values are propagated by the region designated ports at the boundary.

Boundary Ports

In the Cisco prestandard implementation, a boundary port connects an MST region to a single spanning-tree region running RSTP, to a single spanning-tree region running PVST+ or rapid PVST+, or to another MST region with a different MST configuration. A boundary port also connects to a LAN, the designated switch of which is either a single spanning-tree switch or a switch with a different MST configuration.

There is no definition of a boundary port in the IEEE 802.1s standard. The IEEE 802.1Q-2002 standard identifies two kinds of messages that a port can receive: internal (coming from the same region) and external. When a message is external, it is received only by the CIST. If the CIST role is root or alternate, or if the external BPDU is a topology change, it could have an impact on the MST instances. When a message is internal, the CIST part is received by the CIST, and each MST instance receives its respective

M-record. The Cisco prestandard implementation treats a port that receives an external message as a boundary port. This means a port cannot receive a mix of internal and external messages, and this behavior remains in the Cisco standard MST implementation in the Catalyst OS.

An MST region includes both switches and LANs. A segment belongs to the region of its designated port. Therefore, a port in a different region than the designated port for a segment is a boundary port. This definition allows two ports internal to a region to share a segment with a port belonging to a different region, creating the possibility of receiving both internal and external messages on a port.

The primary change from the Cisco prestandard implementation is that a designated port is not defined as boundary, unless it is running in an STP-compatible mode.

**Note**

If there is a legacy STP switch on the segment, messages are always considered external.

The other change from the prestandard implementation is that the CIST regional root switch ID field is now inserted where an RSTP or legacy IEEE 802.1Q switch has the sender switch ID. The whole region performs like a single virtual switch by sending a consistent sender switch ID to neighboring switches. In this example, switch C would receive a BPDU with the same consistent sender switch ID of root, whether or not A or B is designated for the segment.

IEEE 802.1s Implementation

The Cisco implementation of the IEEE MST standard includes features required to meet the standard, as well as the desirable prestandard functionality that is not yet incorporated into the published standard.

Port Role Naming Change

The boundary role is no longer in the final MST standard, but the boundary concept is maintained in Cisco's implementation. However, an MST instance port at a region boundary might not follow the state of the corresponding CIST port. Two cases exist now:

- The boundary port is the root port of the CIST regional root— When the CIST Instance port is proposed and is in sync, it can send back an agreement and move to the forwarding state only after all the corresponding MSTI ports are in sync (and thus forwarding). The MSTI ports now have a special *Master* role.
- The boundary port is not the root port of the CIST regional root—The MSTI ports follow the state and role of the CIST port. The standard provides less information, and it might be difficult to understand why an MSTI port can be alternately blocking when it receives no BPDUs (MRecords). In this case, although the boundary role no longer exists, the **show** commands identify a port as boundary in the *type* column of the output.

Interoperation Between Legacy and Standard Switches

Because automatic detection of prestandard switches can fail, you can use an interface configuration command to identify prestandard ports. A region cannot be formed between a standard and a prestandard switch, but they can interoperate by using the CIST. Only the capability of load balancing over different instances is lost in that particular case. The CLI displays different flags depending on the port configuration when a port receives prestandard BPDUs. A syslog message also appears the first time a switch receives a prestandard BPDU on a port that has not been configured for prestandard BPDU transmission.

Figure 16-2 on page 16-8 illustrates this scenario. Assume that A is a standard switch and B a prestandard switch, both configured to be in the same region. A is the root switch for the CIST, and thus B has a root port (BX) on segment X and an alternate port (BY) on segment Y. If segment Y flaps, and the port on BY becomes the alternate before sending out a single prestandard BPDU, AY cannot detect that a prestandard switch is connected to Y, and continues to send standard BPDUs. The port BY is thus fixed in a boundary, and no load balancing is possible between A and B. The same problem exists on segment X, but , B might transmit topology changes.

Figure 16-2 Standard and Prestandard Switch Interoperation

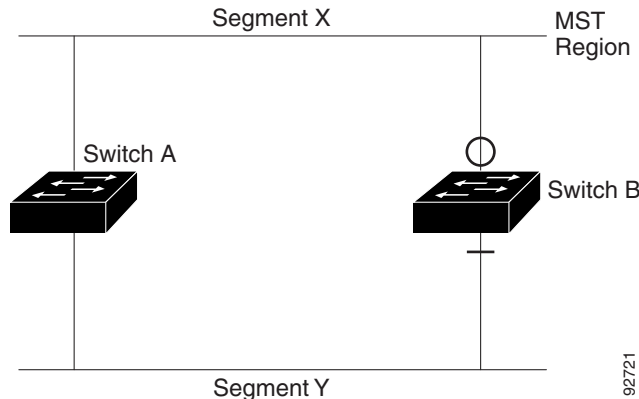

Note

We recommend that you minimize the interaction between standard and prestandard MST implementations.

Detecting Unidirectional Link Failure

This feature is not yet present in the IEEE MST standard, but it is included in this Cisco IOS release. The software checks the consistency of the port role and state in the received BPDUs to detect unidirectional link failures that could cause bridging loops.

When a designated port detects a conflict, it keeps its role, but reverts to discarding state because disrupting connectivity in case of inconsistency is preferable to opening a bridging loop.

Figure 16-3 on page 16-8 illustrates a unidirectional link failure that typically creates a switching loop. Switch A is the root switch, and its BPDUs are lost on the link leading to switch B. RSTP and MST BPDUs include the role and state of the sending port. With this information, switch A can detect that switch B does not react to the superior BPDUs it sends and that switch B is the designated, not root switch. As a result, switch A blocks (or keeps blocking) its port, thus preventing the bridging loop.

Figure 16-3 Detecting Unidirectional Link Failure

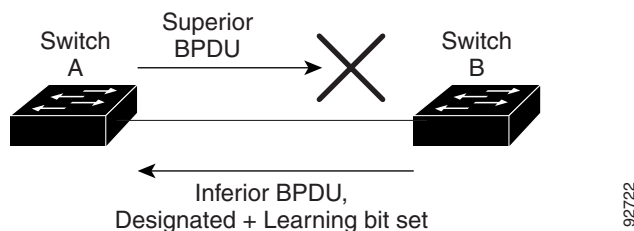

Interoperability with IEEE 802.1D STP

A switch running MSTP supports a built-in protocol migration mechanism that enables it to interoperate with legacy IEEE 802.1D switches. If this switch receives a legacy IEEE 802.1D configuration BPDU (a BPDU with the protocol version set to 0), it sends only IEEE 802.1D BPDUs on that port. An MSTP switch can also detect that a port is at the boundary of a region when it receives a legacy BPDU, an MSTP BPDU (version 3) associated with a different region, or an RSTP BPDU (version 2).

However, the switch does not automatically revert to the MSTP mode if it no longer receives IEEE 802.1D BPDUs because it cannot determine whether the legacy switch has been removed from the link unless the legacy switch is the designated switch. A switch might also continue to assign a boundary role to a port when the switch to which this switch is connected has joined the region. To restart the protocol migration process (force the renegotiation with neighboring switches), use the **clear spanning-tree detected-protocols** privileged EXEC command.

If all the legacy switches on the link are RSTP switches, they can process MSTP BPDUs as if they are RSTP BPDUs. Therefore, MSTP switches send either a version 0 configuration and TCN BPDUs or version 3 MSTP BPDUs on a boundary port. A boundary port connects to a LAN, the designated switch of which is either a single spanning-tree switch or a switch with a different MST configuration.

Understanding RSTP

The RSTP takes advantage of point-to-point wiring and provides rapid convergence of the spanning tree. Reconfiguration of the spanning tree can occur in less than 1 second (in contrast to 50 seconds with the default settings in the IEEE 802.1D spanning tree).

This section describes how the RSTP works:

- [Port Roles and the Active Topology](#), page 16-9
- [Rapid Convergence](#), page 16-10
- [Synchronization of Port Roles](#), page 16-11
- [Bridge Protocol Data Unit Format and Processing](#), page 16-12

For configuration information, see the [“Configuring MSTP Features”](#) section on page 16-14.

Port Roles and the Active Topology

The RSTP provides rapid convergence of the spanning tree by assigning port roles and by determining the active topology. The RSTP builds upon the IEEE 802.1D STP to select the switch with the highest switch priority (lowest numerical priority value) as the root switch as described in the [“Spanning-Tree Topology and BPDUs”](#) section on page 15-2. Then the RSTP assigns one of these port roles to individual ports:

- **Root port**—Provides the best path (lowest cost) when the switch forwards packets to the root switch.
- **Designated port**—Connects to the designated switch, which incurs the lowest path cost when forwarding packets from that LAN to the root switch. The port through which the designated switch is attached to the LAN is called the designated port.
- **Alternate port**—Offers an alternate path toward the root switch to that provided by the current root port.

- Backup port—Acts as a backup for the path provided by a designated port toward the leaves of the spanning tree. A backup port can exist only when two ports are connected in a loopback by a point-to-point link or when a switch has two or more connections to a shared LAN segment.
- Disabled port—Has no role within the operation of the spanning tree.

A port with the root or a designated port role is included in the active topology. A port with the alternate or backup port role is excluded from the active topology.

In a stable topology with consistent port roles throughout the network, the RSTP ensures that every root port and designated port immediately transition to the forwarding state while all alternate and backup ports are always in the discarding state (equivalent to blocking in IEEE 802.1D). The port state controls the operation of the forwarding and learning processes. Table 16-2 provides a comparison of IEEE 802.1D and RSTP port states.

Table 16-2 Port State Comparison

Operational Status	STP Port State (IEEE 802.1D)	RSTP Port State	Is Port Included in the Active Topology?
Enabled	Blocking	Discarding	No
Enabled	Listening	Discarding	No
Enabled	Learning	Learning	Yes
Enabled	Forwarding	Forwarding	Yes
Disabled	Disabled	Discarding	No

To be consistent with Cisco STP implementations, this guide defines the port state as *blocking* instead of *discarding*. Designated ports start in the listening state.

Rapid Convergence

The RSTP provides for rapid recovery of connectivity following the failure of a switch, a switch port, or a LAN. It provides rapid convergence for edge ports, new root ports, and ports connected through point-to-point links as follows:

- Edge ports—If you configure a port as an edge port on an RSTP switch by using the **spanning-tree portfast** interface configuration command, the edge port immediately transitions to the forwarding state. An edge port is the same as a Port Fast-enabled port, and you should enable it only on ports that connect to a single end station.
- Root ports—If the RSTP selects a new root port, it blocks the old root port and immediately transitions the new root port to the forwarding state.
- Point-to-point links—If you connect a port to another port through a point-to-point link and the local port becomes a designated port, it negotiates a rapid transition with the other port by using the proposal-agreement handshake to ensure a loop-free topology.

As shown in Figure 16-4, Switch A is connected to Switch B through a point-to-point link, and all of the ports are in the blocking state. Assume that the priority of Switch A is a smaller numerical value than the priority of Switch B. Switch A sends a proposal message (a configuration BPDU) with the proposal flag set to Switch B, proposing itself as the designated switch.

After receiving the proposal message, Switch B selects as its new root port the port from which the proposal message was received, forces all nonedge ports to the blocking state, and sends an agreement message (a BPDU with the agreement flag set) through its new root port.

After receiving Switch B's agreement message, Switch A also immediately transitions its designated port to the forwarding state. No loops in the network are formed because Switch B blocked all of its nonedge ports and because there is a point-to-point link between Switches A and B.

When Switch C is connected to Switch B, a similar set of handshaking messages are exchanged. Switch C selects the port connected to Switch B as its root port, and both ends immediately transition to the forwarding state. With each iteration of this handshaking process, one more switch joins the active topology. As the network converges, this proposal-agreement handshaking progresses from the root toward the leaves of the spanning tree.

The switch determines the link type from the port duplex mode: a full-duplex port is considered to have a point-to-point connection; a half-duplex port is considered to have a shared connection. You can override the default setting that is determined by the duplex setting by using the **spanning-tree link-type** interface configuration command.

Figure 16-4 Proposal and Agreement Handshaking for Rapid Convergence

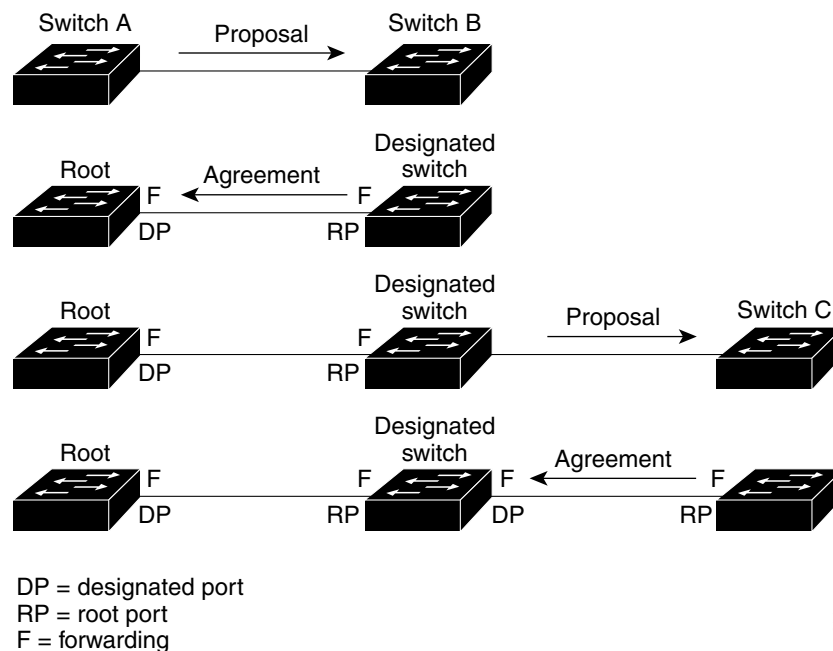

Synchronization of Port Roles

When the switch receives a proposal message on one of its ports and that port is selected as the new root port, the RSTP forces all other ports to synchronize with the new root information.

The switch is synchronized with superior root information received on the root port if all other ports are synchronized. An individual port on the switch is synchronized if

- That port is in the blocking state
- It is an edge port (a port configured to be at the edge of the network)

If a designated port is in the forwarding state and is not configured as an edge port, it transitions to the blocking state when the RSTP forces it to synchronize with new root information. In general, when the RSTP forces a port to synchronize with root information and the port does not satisfy any of the above conditions, its port state is set to blocking.

After ensuring that all of the ports are synchronized, the switch sends an agreement message to the designated switch corresponding to its root port. When the switches connected by a point-to-point link are in agreement about their port roles, the RSTP immediately transitions the port states to forwarding. The sequence of events is shown in Figure 16-5.

Figure 16-5 Sequence of Events During Rapid Convergence

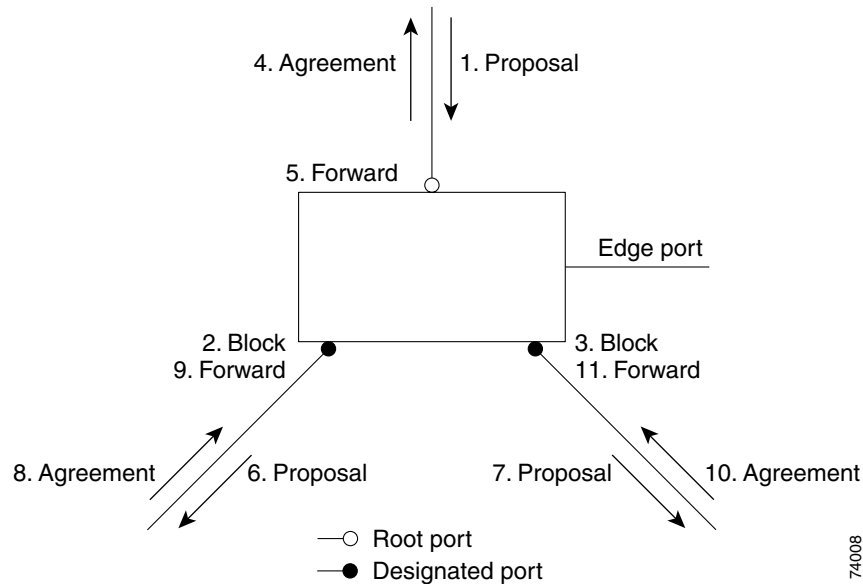

Bridge Protocol Data Unit Format and Processing

The RSTP BPDU format is the same as the IEEE 802.1D BPDU format except that the protocol version is set to 2. A new 1-byte version 1 Length field is set to zero, which means that no version 1 protocol information is present. Table 16-3 shows the RSTP flag fields.

Table 16-3 RSTP BPDU Flags

Bit	Function
0	Topology change (TC)
1	Proposal
2–3:	Port role:
00	Unknown
01	Alternate port
10	Root port
11	Designated port
4	Learning
5	Forwarding
6	Agreement
7	Topology change acknowledgement (TCA)

The sending switch sets the proposal flag in the RSTP BPDU to propose itself as the designated switch on that LAN. The port role in the proposal message is always set to the designated port.

The sending switch sets the agreement flag in the RSTP BPDU to accept the previous proposal. The port role in the agreement message is always set to the root port.

The RSTP does not have a separate topology change notification (TCN) BPDU. It uses the topology change (TC) flag to show the topology changes. However, for interoperability with IEEE 802.1D switches, the RSTP switch processes and generates TCN BPDUs.

The learning and forwarding flags are set according to the state of the sending port.

Processing Superior BPDU Information

If a port receives superior root information (lower switch ID, lower path cost, and so forth) than currently stored for the port, the RSTP triggers a reconfiguration. If the port is proposed and is selected as the new root port, RSTP forces all the other ports to synchronize.

If the BPDU received is an RSTP BPDU with the proposal flag set, the switch sends an agreement message after all of the other ports are synchronized. If the BPDU is an IEEE 802.1D BPDU, the switch does not set the proposal flag and starts the forward-delay timer for the port. The new root port requires twice the forward-delay time to transition to the forwarding state.

If the superior information received on the port causes the port to become a backup or alternate port, RSTP sets the port to the blocking state but does not send the agreement message. The designated port continues sending BPDUs with the proposal flag set until the forward-delay timer expires, at which time the port transitions to the forwarding state.

Processing Inferior BPDU Information

If a designated port receives an inferior BPDU (higher switch ID, higher path cost, and so forth than currently stored for the port) with a designated port role, it immediately replies with its own information.

Topology Changes

This section describes the differences between the RSTP and the IEEE 802.1D in handling spanning-tree topology changes.

- **Detection**—Unlike IEEE 802.1D in which *any* transition between the blocking and the forwarding state causes a topology change, *only* transitions from the blocking to the forwarding state cause a topology change with RSTP (only an increase in connectivity is considered a topology change). State changes on an edge port do not cause a topology change. When an RSTP switch detects a topology change, it deletes the learned information on all of its nonedge ports except on those from which it received the TC notification.
- **Notification**—Unlike IEEE 802.1D, which uses TCN BPDUs, the RSTP does not use them. However, for IEEE 802.1D interoperability, an RSTP switch processes and generates TCN BPDUs.
- **Acknowledgement**—When an RSTP switch receives a TCN message on a designated port from an IEEE 802.1D switch, it replies with an IEEE 802.1D configuration BPDU with the TCA bit set. However, if the TC-while timer (the same as the topology-change timer in IEEE 802.1D) is active on a root port connected to an IEEE 802.1D switch and a configuration BPDU with the TCA bit set is received, the TC-while timer is reset.

This behavior is only required to support IEEE 802.1D switches. The RSTP BPDUs never have the TCA bit set.

- **Propagation**—When an RSTP switch receives a TC message from another switch through a designated or root port, it propagates the change to all of its nonedge, designated ports and to the root port (excluding the port on which it is received). The switch starts the TC-while timer for all such ports and flushes the information learned on them.
- **Protocol migration**—For backward compatibility with IEEE 802.1D switches, RSTP selectively sends IEEE 802.1D configuration BPDUs and TCN BPDUs on a per-port basis.

When a port is initialized, the migrate-delay timer is started (specifies the minimum time during which RSTP BPDUs are sent), and RSTP BPDUs are sent. While this timer is active, the switch processes all BPDUs received on that port and ignores the protocol type.

If the switch receives an IEEE 802.1D BPDU after the port migration-delay timer has expired, it assumes that it is connected to an IEEE 802.1D switch and starts using only IEEE 802.1D BPDUs. However, if the RSTP switch is using IEEE 802.1D BPDUs on a port and receives an RSTP BPDU after the timer has expired, it restarts the timer and starts using RSTP BPDUs on that port.

Configuring MSTP Features

These sections describe how to configure basic MSTP features:

- [Default MSTP Configuration, page 16-15](#)
- [MSTP Configuration Guidelines, page 16-15](#)
- [Specifying the MST Region Configuration and Enabling MSTP, page 16-16](#) (required)
- [Configuring the Root Switch, page 16-17](#) (optional)
- [Configuring a Secondary Root Switch, page 16-19](#) (optional)
- [Configuring the Port Priority, page 16-20](#) (optional)
- [Configuring the Path Cost, page 16-21](#) (optional)
- [Configuring the Switch Priority, page 16-22](#) (optional)
- [Configuring the Hello Time, page 16-23](#) (optional)
- [Configuring the Forwarding-Delay Time, page 16-23](#) (optional)
- [Configuring the Maximum-Aging Time, page 16-24](#) (optional)
- [Configuring the Maximum-Hop Count, page 16-24](#) (optional)
- [Specifying the Link Type to Ensure Rapid Transitions, page 16-25](#) (optional)
- [Designating the Neighbor Type, page 16-25](#)
- [Restarting the Protocol Migration Process, page 16-26](#) (optional)

Default MSTP Configuration

Table 16-4 shows the default MSTP configuration.

Table 16-4 Default MSTP Configuration

Feature	Default Setting
Spanning-tree mode	PVST+ (Rapid PVST+ and MSTP are disabled).
Switch priority (configurable on a per-CIST interface basis)	32768.
Spanning-tree port priority (configurable on a per-CIST interface basis)	128.
Spanning-tree port cost (configurable on a per-CIST interface basis)	1000 Mbps: 4. 100 Mbps: 19 10 Mbps: 100.
Hello time	2 seconds.
Forward-delay time	15 seconds.
Maximum-aging time	20 seconds.
Maximum hop count	20 hops.

For information about the supported number of spanning-tree instances, see the [“Supported Spanning-Tree Instances”](#) section on page 15-9.

MSTP Configuration Guidelines

These are the configuration guidelines for MSTP:

- When you enable MST by using the **spanning-tree mode mst** global configuration command, RSTP is automatically enabled. Per-VLAN RSTP is not supported in software releases earlier than Cisco IOS Release 12.1(13)EA1.
- For two or more switches to be in the same MST region, they must have the same VLAN-to-instance map, the same configuration revision number, and the same name.
- The switch supports up to 65 MST instances. The number of VLANs that can be mapped to a particular MST instance is unlimited.
- PVST+, rapid PVST+, and MSTP are supported, but only one version can be active at any time. (For example, all VLANs run PVST+, all VLANs run rapid PVST+, or all VLANs run MSTP.) For more information, see the [“Spanning-Tree Interoperability and Backward Compatibility”](#) section on page 15-10. For information on the recommended trunk port configuration, see the [“Interaction with Other Features”](#) section on page 11-19.
- VTP propagation of the MST configuration is not supported. However, you can manually configure the MST configuration (region name, revision number, and VLAN-to-instance mapping) on each switch within the MST region by using the command-line interface (CLI) or through the SNMP support.
- For load balancing across redundant paths in the network to work, all VLAN-to-instance mapping assignments must match; otherwise, all traffic flows on a single link.

- All MST boundary ports must be forwarding for load balancing between a PVST+ and an MST cloud or between a rapid-PVST+ and an MST cloud. For this to occur, the IST master of the MST cloud should also be the root of the CST. If the MST cloud consists of multiple MST regions, one of the MST regions must contain the CST root, and all of the other MST regions must have a better path to the root contained within the MST cloud than a path through the PVST+ or rapid-PVST+ cloud. You might have to manually configure the switches in the clouds.
- Partitioning the network into a large number of regions is not recommended. However, if this situation is unavoidable, we recommend that you partition the switched LAN into smaller LANs interconnected by routers or non-Layer 2 devices.
- For configuration guidelines about UplinkFast, BackboneFast, and cross-stack UplinkFast, see the [“Optional Spanning-Tree Configuration Guidelines”](#) section on page 17-14.

Specifying the MST Region Configuration and Enabling MSTP

For two or more switches to be in the same MST region, they must have the same VLAN-to-instance mapping, the same configuration revision number, and the same name.

A region can have one member or multiple members with the same MST configuration; each member must be capable of processing RSTP BPDUs. There is no limit to the number of MST regions in a network, but each region can only support up to 65 spanning-tree instances. You can assign a VLAN to only one spanning-tree instance at a time.

Beginning in privileged EXEC mode, follow these steps to specify the MST region configuration and enable MSTP. This procedure is required.

	Command	Purpose
Step 1	configure terminal	Enter global configuration mode.
Step 2	spanning-tree mst configuration	Enter MST configuration mode.
Step 3	instance <i>instance-id</i> vlan <i>vlan-range</i>	Map VLANs to an MST instance. <ul style="list-style-type: none"> • For <i>instance-id</i>, you can specify a single instance, a range of instances separated by a hyphen, or a series of instances separated by a comma. The range is 1 to 4094. • For vlan <i>vlan-range</i>, the range is 1 to 4094. <p>When you map VLANs to an MST instance, the mapping is incremental, and the VLANs specified in the command are added to or removed from the VLANs that were previously mapped.</p> <p>To specify a VLAN range, use a hyphen; for example, instance 1 vlan 1-63 maps VLANs 1 through 63 to MST instance 1.</p> <p>To specify a VLAN series, use a comma; for example, instance 1 vlan 10, 20, 30 maps VLANs 10, 20, and 30 to MST instance 1.</p>
Step 4	name <i>name</i>	Specify the configuration name. The <i>name</i> string has a maximum length of 32 characters and is case sensitive.
Step 5	revision <i>version</i>	Specify the configuration revision number. The range is 0 to 65535.
Step 6	show pending	Verify your configuration by displaying the pending configuration.
Step 7	exit	Apply all changes, and return to global configuration mode.

	Command	Purpose
Step 8	<code>spanning-tree mode mst</code>	Enable MSTP. RSTP is also enabled.  Caution Changing spanning-tree modes can disrupt traffic because all spanning-tree instances are stopped for the previous mode and restarted in the new mode. You cannot run both MSTP and PVST+ or both MSTP and rapid PVST+ at the same time.
Step 9	<code>end</code>	Return to privileged EXEC mode.
Step 10	<code>show running-config</code>	Verify your entries.
Step 11	<code>copy running-config startup-config</code>	(Optional) Save your entries in the configuration file.

To return to the default MST region configuration, use the **no spanning-tree mst configuration** global configuration command. To return to the default VLAN-to-instance map, use the **no instance *instance-id* [vlan *vlan-range*]** MST configuration command. To return to the default name, use the **no name** MST configuration command. To return to the default revision number, use the **no revision** MST configuration command. To re-enable PVST+, use the **no spanning-tree mode** or the **spanning-tree mode pvst** global configuration command.

This example shows how to enter MST configuration mode, map VLANs 10 to 20 to MST instance 1, name the region *region1*, set the configuration revision to 1, display the pending configuration, apply the changes, and return to global configuration mode:

```
Switch(config)# spanning-tree mst configuration
Switch(config-mst)# instance 1 vlan 10-20
Switch(config-mst)# name region1
Switch(config-mst)# revision 1
Switch(config-mst)# show pending
Pending MST configuration
Name      [region1]
Revision  1
Instance  Vlans Mapped
-----
0         1-9,21-4094
1         10-20
-----

Switch(config-mst)# exit
Switch(config)#
```

Configuring the Root Switch

The switch maintains a spanning-tree instance for the group of VLANs mapped to it. A switch ID, consisting of the switch priority and the switch MAC address, is associated with each instance. The switch with the lowest switch ID becomes the root switch for the group of VLANs.

To configure a switch to become the root, use the **spanning-tree mst *instance-id* root** global configuration command to modify the switch priority from the default value (32768) to a significantly lower value so that the switch becomes the root switch for the specified spanning-tree instance. When you enter this command, the switch checks the switch priorities of the root switches. Because of the extended system ID support, the switch sets its own priority for the specified instance to 24576 if this value will cause this switch to become the root for the specified spanning-tree instance.

If any root switch for the specified instance has a switch priority lower than 24576, the switch sets its own priority to 4096 less than the lowest switch priority. (4096 is the value of the least-significant bit of a 4-bit switch priority value as shown in [Table 15-1 on page 15-4](#).)

**Note**

Catalyst 3550 switches running software earlier than Cisco IOS Release 12.1(8)EA1 do not support the extended system ID. Catalyst 3550 switches running software earlier than Cisco IOS Release 12.1(9)EA1 do not support the MSTP.

If your network consists of switches that both do and do not support the extended system ID, it is unlikely that the switch with the extended system ID support will become the root switch. The extended system ID increases the switch priority value every time the VLAN number is greater than the priority of the connected switches running older software.

The root switch for each spanning-tree instance should be a backbone or distribution switch. Do not configure an access switch as the spanning-tree primary root.

Use the **diameter** keyword, which is available only for MST instance 0, to specify the Layer 2 network diameter (that is, the maximum number of switch hops between any two end stations in the Layer 2 network). When you specify the network diameter, the switch automatically sets an optimal hello time, forward-delay time, and maximum-age time for a network of that diameter, which can significantly reduce the convergence time. You can use the **hello** keyword to override the automatically calculated hello time.

**Note**

After configuring the switch as the root switch, we recommend that you avoid manually configuring the hello time, forward-delay time, and maximum-age time by using the **spanning-tree mst hello-time**, **spanning-tree mst forward-time**, and the **spanning-tree mst max-age** global configuration commands after configuring the switch as the root switch.

Beginning in privileged EXEC mode, follow these steps to configure a switch as the root switch. This procedure is optional.

	Command	Purpose
Step 1	configure terminal	Enter global configuration mode.
Step 2	spanning-tree mst <i>instance-id</i> root primary [diameter <i>net-diameter</i> [hello-time <i>seconds</i>]]	Configure a switch as the root switch. <ul style="list-style-type: none"> For <i>instance-id</i>, you can specify a single instance, a range of instances separated by a hyphen, or a series of instances separated by a comma. The range is 0 to 4094. (Optional) For diameter <i>net-diameter</i>, specify the maximum number of switches between any two end stations. The range is 2 to 7. This keyword is available only for MST instance 0. (Optional) For hello-time <i>seconds</i>, specify the interval in seconds between the generation of configuration messages by the root switch. The range is 1 to 10 seconds; the default is 2 seconds.
Step 3	end	Return to privileged EXEC mode.
Step 4	show spanning-tree mst <i>instance-id</i>	Verify your entries.
Step 5	copy running-config startup-config	(Optional) Save your entries in the configuration file.

To return the switch to its default setting, use the **no spanning-tree mst *instance-id* root** global configuration command.

Configuring a Secondary Root Switch

When you configure a Catalyst 3550 switch that supports the extended system ID as the secondary root, the spanning-tree switch priority is modified from the default value (32768) to 28672. The switch is then likely to become the root switch for the specified instance if the primary root switch fails. This is assuming that the other network switches use the default switch priority of 32768 and therefore are unlikely to become the root switch. For Catalyst 3550 switches without the extended system ID support (software earlier than Cisco IOS Release 12.1(8)EA1), the switch priority is changed to 16384.

You can execute this command on more than one switch to configure multiple backup root switches. Use the same network diameter and hello-time values that you used when you configured the primary root switch with the **spanning-tree mst *instance-id* root primary** global configuration command.

Beginning in privileged EXEC mode, follow these steps to configure a switch as the secondary root switch. This procedure is optional.

	Command	Purpose
Step 1	configure terminal	Enter global configuration mode.
Step 2	spanning-tree mst <i>instance-id</i> root secondary [diameter <i>net-diameter</i> [hello-time <i>seconds</i>]]	Configure a switch as the secondary root switch. <ul style="list-style-type: none"> For <i>instance-id</i>, you can specify a single instance, a range of instances separated by a hyphen, or a series of instances separated by a comma. The range is 0 to 4094. (Optional) For diameter <i>net-diameter</i>, specify the maximum number of switches between any two end stations. The range is 2 to 7. This keyword is available only for MST instance 0. (Optional) For hello-time <i>seconds</i>, specify the interval in seconds between the generation of configuration messages by the root switch. The range is 1 to 10 seconds; the default is 2 seconds. Use the same network diameter and hello-time values that you used when configuring the primary root switch. See the “Configuring the Root Switch” section on page 16-17.
Step 3	end	Return to privileged EXEC mode.
Step 4	show spanning-tree mst <i>instance-id</i>	Verify your entries.
Step 5	copy running-config startup-config	(Optional) Save your entries in the configuration file.

To return the switch to its default setting, use the **no spanning-tree mst *instance-id* root** global configuration command.

Configuring the Port Priority

If a loop occurs, the MSTP uses the port priority when selecting an interface to put into the forwarding state. You can assign higher priority values (lower numerical values) to interfaces that you want selected first and lower priority values (higher numerical values) that you want selected last. If all interfaces have the same priority value, the MSTP puts the interface with the lowest interface number in the forwarding state and blocks the other interfaces.

Beginning in privileged EXEC mode, follow these steps to configure the MSTP port priority of an interface. This procedure is optional.

	Command	Purpose
Step 1	configure terminal	Enter global configuration mode.
Step 2	interface <i>interface-id</i>	Specify an interface to configure, and enter interface configuration mode. Valid interfaces include physical ports and port channels. Valid port-channel numbers are 1 to 64.
Step 3	spanning-tree mst <i>instance-id</i> port-priority <i>priority</i>	Configure the port priority for an MST instance. <ul style="list-style-type: none"> For <i>instance-id</i>, you can specify a single instance, a range of instances separated by a hyphen, or a series of instances separated by a comma. The range is 0 to 4094. For <i>priority</i>, the range is 0 to 240 in increments of 16. The default is 128. The lower the number, the higher the priority. Valid priority values are 0, 16, 32, 48, 64, 80, 96, 112, 128, 144, 160, 176, 192, 208, 224, and 240. All other values are rejected.
Step 4	end	Return to privileged EXEC mode.
Step 5	show spanning-tree mst interface <i>interface-id</i> or show spanning-tree mst <i>instance-id</i>	Verify your entries.
Step 6	copy running-config startup-config	(Optional) Save your entries in the configuration file.



Note

The **show spanning-tree mst interface** *interface-id* privileged EXEC command displays information only if the port is in a link-up operative state. Otherwise, you can use the **show running-config interface** privileged EXEC command to confirm the configuration.

To return the interface to its default setting, use the **no spanning-tree mst** *instance-id* **port-priority** interface configuration command.

Configuring the Path Cost

The MSTP path cost default value is derived from the media speed of an interface. If a loop occurs, the MSTP uses cost when selecting an interface to put in the forwarding state. You can assign lower cost values to interfaces that you want selected first and higher cost values that you want selected last. If all interfaces have the same cost value, the MSTP puts the interface with the lowest interface number in the forwarding state and blocks the other interfaces.

Beginning in privileged EXEC mode, follow these steps to configure the MSTP cost of an interface. This procedure is optional.

	Command	Purpose
Step 1	configure terminal	Enter global configuration mode.
Step 2	interface <i>interface-id</i>	Specify an interface to configure, and enter interface configuration mode. Valid interfaces include physical ports and port channels. Valid port-channel numbers are 1 to 64.
Step 3	spanning-tree mst <i>instance-id</i> cost <i>cost</i>	Configure the cost for an MST instance. If a loop occurs, the MSTP uses the path cost when selecting an interface to place into the forwarding state. A lower path cost represents higher-speed transmission. <ul style="list-style-type: none"> For <i>instance-id</i>, you can specify a single instance, a range of instances separated by a hyphen, or a series of instances separated by a comma. The range is 0 to 4094. For <i>cost</i>, the range is 1 to 200000000; the default value is derived from the media speed of the interface.
Step 4	end	Return to privileged EXEC mode.
Step 5	show spanning-tree mst interface <i>interface-id</i> or show spanning-tree mst <i>instance-id</i>	Verify your entries.
Step 6	copy running-config startup-config	(Optional) Save your entries in the configuration file.



Note

The **show spanning-tree mst interface** *interface-id* privileged EXEC command displays information only for ports that are in a link-up operative state. Otherwise, you can use the **show running-config** privileged EXEC command to confirm the configuration.

To return the interface to its default setting, use the **no spanning-tree mst** *instance-id* **cost** interface configuration command.

Configuring the Switch Priority

You can configure the switch priority and make it more likely that the switch will be chosen as the root switch.



Note

Exercise care when using this command. For most situations, we recommend that you use the **spanning-tree mst *instance-id* root primary** and the **spanning-tree mst *instance-id* root secondary** global configuration commands to modify the switch priority.

Beginning in privileged EXEC mode, follow these steps to configure the switch priority. This procedure is optional.

	Command	Purpose
Step 1	configure terminal	Enter global configuration mode.
Step 2	spanning-tree mst <i>instance-id</i> priority <i>priority</i>	Configure the switch priority for an MST instance. <ul style="list-style-type: none"> For <i>instance-id</i>, you can specify a single instance, a range of instances separated by a hyphen, or a series of instances separated by a comma. The range is 0 to 4094. For <i>priority</i>, the range is 0 to 61440 in increments of 4096; the default is 32768. The lower the number, the more likely the switch will be chosen as the root switch. Valid priority values are 0, 4096, 8192, 12288, 16384, 20480, 24576, 28672, 32768, 36864, 40960, 45056, 49152, 53248, 57344, and 61440. All other values are rejected.
Step 3	end	Return to privileged EXEC mode.
Step 4	show spanning-tree mst <i>instance-id</i>	Verify your entries.
Step 5	copy running-config startup-config	(Optional) Save your entries in the configuration file.

To return the switch to its default setting, use the **no spanning-tree mst *instance-id* priority** global configuration command.

Configuring the Hello Time

You can configure the interval between the generation of configuration messages by the root switch by changing the hello time.

Beginning in privileged EXEC mode, follow these steps to configure the hello time for all MST instances. This procedure is optional.

	Command	Purpose
Step 1	configure terminal	Enter global configuration mode.
Step 2	spanning-tree mst hello-time <i>seconds</i>	Configure the hello time for all MST instances. The hello time is the interval between the generation of configuration messages by the root switch. These messages mean that the switch is alive. For <i>seconds</i> , the range is 1 to 10; the default is 2.
Step 3	end	Return to privileged EXEC mode.
Step 4	show spanning-tree mst	Verify your entries.
Step 5	copy running-config startup-config	(Optional) Save your entries in the configuration file.

To return the switch to its default setting, use the **no spanning-tree mst hello-time** global configuration command.

Configuring the Forwarding-Delay Time

Beginning in privileged EXEC mode, follow these steps to configure the forwarding-delay time for all MST instances. This procedure is optional.

	Command	Purpose
Step 1	configure terminal	Enter global configuration mode.
Step 2	spanning-tree mst forward-time <i>seconds</i>	Configure the forward time for all MST instances. The forward delay is the number of seconds a port waits before changing from its spanning-tree learning and listening states to the forwarding state. For <i>seconds</i> , the range is 4 to 30; the default is 15.
Step 3	end	Return to privileged EXEC mode.
Step 4	show spanning-tree mst	Verify your entries.
Step 5	copy running-config startup-config	(Optional) Save your entries in the configuration file.

To return the switch to its default setting, use the **no spanning-tree mst forward-time** global configuration command.

Configuring the Maximum-Aging Time

Beginning in privileged EXEC mode, follow these steps to configure the maximum-aging time for all MST instances. This procedure is optional.

	Command	Purpose
Step 1	<code>configure terminal</code>	Enter global configuration mode.
Step 2	<code>spanning-tree mst max-age <i>seconds</i></code>	Configure the maximum-aging time for all MST instances. The maximum-aging time is the number of seconds a switch waits without receiving spanning-tree configuration messages before attempting a reconfiguration. For <i>seconds</i> , the range is 6 to 40; the default is 20.
Step 3	<code>end</code>	Return to privileged EXEC mode.
Step 4	<code>show spanning-tree mst</code>	Verify your entries.
Step 5	<code>copy running-config startup-config</code>	(Optional) Save your entries in the configuration file.

To return the switch to its default setting, use the **no spanning-tree mst max-age** global configuration command.

Configuring the Maximum-Hop Count

Beginning in privileged EXEC mode, follow these steps to configure the maximum-hop count for all MST instances. This procedure is optional.

	Command	Purpose
Step 1	<code>configure terminal</code>	Enter global configuration mode.
Step 2	<code>spanning-tree mst max-hops <i>hop-count</i></code>	Specify the number of hops in a region before the BPDU is discarded, and the information held for a port is aged. For <i>hop-count</i> , the range is 1 to 255; the default is 20.
Step 3	<code>end</code>	Return to privileged EXEC mode.
Step 4	<code>show spanning-tree mst</code>	Verify your entries.
Step 5	<code>copy running-config startup-config</code>	(Optional) Save your entries in the configuration file.

To return the switch to its default setting, use the **no spanning-tree mst max-hops** global configuration command.

Specifying the Link Type to Ensure Rapid Transitions

If you connect a port to another port through a point-to-point link and the local port becomes a designated port, the RSTP negotiates a rapid transition with the other port by using the proposal-agreement handshake to ensure a loop-free topology as described in the “[Rapid Convergence](#)” section on page 16-10.

By default, the link type is determined from the duplex mode of the interface: a full-duplex port is considered to have a point-to-point connection; a half-duplex port is considered to have a shared connection. If you have a half-duplex link physically connected point-to-point to a single port on a remote switch running MSTP, you can override the default setting of the link type and enable rapid transitions to the forwarding state.

Beginning in privileged EXEC mode, follow these steps to override the default link-type setting. This procedure is optional.

	Command	Purpose
Step 1	configure terminal	Enter global configuration mode.
Step 2	interface <i>interface-id</i>	Specify the interface to configure, and enter interface configuration mode. Valid interfaces include physical ports, VLANs, and port channels. Valid VLAN IDs are 1 to 4094. Valid port-channel numbers are 1 to 64.
Step 3	spanning-tree link-type point-to-point	Specify that the link type of a port is point-to-point.
Step 4	end	Return to privileged EXEC mode.
Step 5	show spanning-tree mst interface <i>interface-id</i>	Verify your entries.
Step 6	copy running-config startup-config	(Optional) Save your entries in the configuration file.

To return the switch to its default setting, use the **no spanning-tree link-type** interface configuration command.

Designating the Neighbor Type

A topology could contain both prestandard and IEEE 802.1s standard compliant devices. By default, ports can automatically detect prestandard devices, but they can still receive both standard and prestandard BPDUs. When there is a mismatch between a device and its neighbor, only the CIST runs on the interface.

You can choose to set a port to send only prestandard BPDUs. The prestandard flag appears in all the show commands, even if the port is in STP compatibility mode.

Beginning in privileged EXEC mode, follow these steps to override the default link-type setting. This procedure is optional.

	Command	Purpose
Step 1	configure terminal	Enter global configuration mode.
Step 2	interface <i>interface-id</i>	Specify an interface to configure, and enter interface configuration mode. Valid interfaces include physical ports.
Step 3	spanning-tree mst pre-standard	Specify that the port can send only prestandard BPDUs.

	Command	Purpose
Step 4	end	Return to privileged EXEC mode.
Step 5	show spanning-tree mst interface <i>interface-id</i>	Verify your entries.
Step 6	copy running-config startup-config	(Optional) Save your entries in the configuration file.

To return the port to its default setting, use the **no spanning-tree mst pre-standard** interface configuration command.

Restarting the Protocol Migration Process

A switch running MSTP supports a built-in protocol migration mechanism that enables it to interoperate with legacy IEEE 802.1D switches. If this switch receives a legacy IEEE 802.1D configuration BPDU (a BPDU with the protocol version set to 0), it sends only IEEE 802.1D BPDUs on that port. An MSTP switch can also detect that a port is at the boundary of a region when it receives a legacy BPDU, an MST BPDU (version 3) associated with a different region, or an RST BPDU (version 2).

However, the switch does not automatically revert to the MSTP mode if it no longer receives IEEE 802.1D BPDUs because it cannot determine whether the legacy switch has been removed from the link unless the legacy switch is the designated switch. A switch also might continue to assign a boundary role to a port when the switch to which it is connected has joined the region.

To restart the protocol migration process (force the renegotiation with neighboring switches) on the switch, use the **clear spanning-tree detected-protocols** privileged EXEC command.

To restart the protocol migration process on a specific interface, use the **clear spanning-tree detected-protocols interface** *interface-id* privileged EXEC command.

Displaying the MST Configuration and Status

To display the spanning-tree status, use one or more of the privileged EXEC commands in [Table 16-5](#):

Table 16-5 Commands for Displaying MST Status

Command	Purpose
show spanning-tree mst configuration	Displays the MST region configuration.
show spanning-tree mst configuration digest	Displays the MD5 digest included in the current MSTCI.
show spanning-tree mst <i>instance-id</i>	Displays MST information for the specified instance.
show spanning-tree mst interface <i>interface-id</i>	Displays MST information for the specified interface. Valid interfaces include physical ports, VLANs, and port channels. Valid VLAN IDs are 1 to 4094. The valid port-channel range is 1 to 64.

For information about other keywords for the **show spanning-tree** privileged EXEC command, see the command reference for this release.