



Getting Started with CMS

This chapter contains these sections that describe the Cluster Management Suite (CMS) on the Catalyst 2970 switch:

- “Understanding CMS” section on page 3-1
- “Configuring CMS” section on page 3-8
- “Displaying CMS” section on page 3-11
- “Where to Go Next” section on page 3-16

For a list of new CMS features in this release, select **Help > What's New?** from the CMS menu bar.

For information about cluster configurations and which Catalyst switches can be command switches or member switches, refer to the release notes for this switch.

Refer to the appropriate switch documentation for descriptions of the browser-based management software used on other Catalyst switches. For more information about CMS, refer to the online help.

Understanding CMS

CMS provides these features for managing switch clusters and individual switches from web browsers such as Netscape Communicator or Microsoft Internet Explorer:

- Front-panel and topology views of your network, as shown in [Figure 3-7 on page 3-14](#) and [Figure 3-8 on page 3-15](#), that can be displayed at the same time
- A menu bar, a toolbar, and a feature bar, as shown in [Figure 3-6 on page 3-14](#), to access configuration and management options
- Comprehensive online help that gives high-level concepts and procedures for performing CMS tasks
- Interactive modes—guide mode, expert mode, and wizards—that control the presentation of some complex configuration options
- Two levels of access modes to the configuration options: read-write access for users who can change switch settings and read-only access for users who can only view switch settings

Front Panel View

The Front Panel view displays the front-panel image of a specific set of switches in a cluster. From this view, you can select multiple ports or multiple switches and configure them with the same settings.

For more information, see the “[Displaying CMS](#)” section on page 3-11.

Topology View

The Topology view displays a network map that uses icons representing switch clusters, the command switch, cluster members, cluster candidates, neighboring devices that are not eligible to join a cluster, and link types. You can also display link information in the form of link reports and link graphs.

For more information, see the “[Displaying CMS](#)” section on page 3-11.

CMS Menu Bar, Toolbar, and Feature Bar

The configuration and monitoring options for configuring switches and switch clusters are available from the menu bar, the toolbar, and the feature bar.

- The menu bar, shown in [Figure 3-1](#), provides these options for managing CMS, navigating the windows, and accessing online help:
 - CMS—Choose printing options, select interaction modes, display CMS preferences, save CMS cluster information on your PC or workstation, and show or hide the feature bar.



Note CMS is downloaded to your browser each time that you launch CMS. You can increase the speed at which CMS loads by permanently installing CMS on your PC or workstation. Select **CMS > Installation and Distributions**, and click **Install**. CMS is installed locally and loads faster the next time that you launch it.

















- Window—Choose from the currently open CMS windows.
- Help—Launch the online help.

Figure 3-1 Menu Bar



- The toolbar provides buttons for commonly used switch and cluster configuration options and information windows such as legends and online help. [Table 3-1](#) lists the toolbar options from left to right on the toolbar.

Table 3-1 *Toolbar Buttons*

Toolbar Option	Icon	Task
Print		Print a CMS window or help file.
Preferences ¹		Set CMS display properties, such as polling intervals, the views to open at CMS startup, and the color of administratively shutdown ports.
Save Configuration ²		Save the configuration of the cluster or a switch to flash memory.
Software Upgrade ²		Upgrade the software for the cluster or a switch.
Port Settings ¹		Display and configure port parameters on a switch.
Smartports Device Macros		Display or configure Smartports macros on a switch.
Smartports Port Macros		Display or configure Smartports macros on a port.
VLAN ¹		Display VLAN membership, assign ports to VLANs, and change the administration mode.
Inventory		Display the device type, the software version, the IP address, and other information about a switch.
Refresh		Update the views with the latest status.
Front Panel		Display the Front Panel view.
Topology		Display the Topology view.
Topology Options		Select the information to be displayed in the Topology view.
Save Topology Layout ²		Save your arrangement of the cluster icons in the Topology view to flash memory.
Legend		Display the legend that describes the icons, labels, and links.
Help for Active Window		Display the help for the active, open window. You can also click Help from the active window or press the F1 key.

1. Not available in read-only mode. For more information about the read-only and read-write access modes, see the “[Privilege Levels](#)” section on page 3-7.

2. Some options from this menu option are not available in read-only mode.

- The feature bar shows the features available for the devices in your cluster. By default, the feature bar is in standard mode. In this mode, the feature bar is always visible, and you can reduce or increase the width of the feature bar. In autohide mode, the feature bar appears only when you move the cursor to the left edge of the CMS workspace.
 - To enable the feature bar, click **CMS > Feature Bar**, and select **Standard Mode**.
 - To hide the feature bar, click **CMS > Feature Bar**, and select **Autohide Mode**.

Figure 3-2 shows the features available in a sample cluster.

Figure 3-2 Features Tab and Search Tab

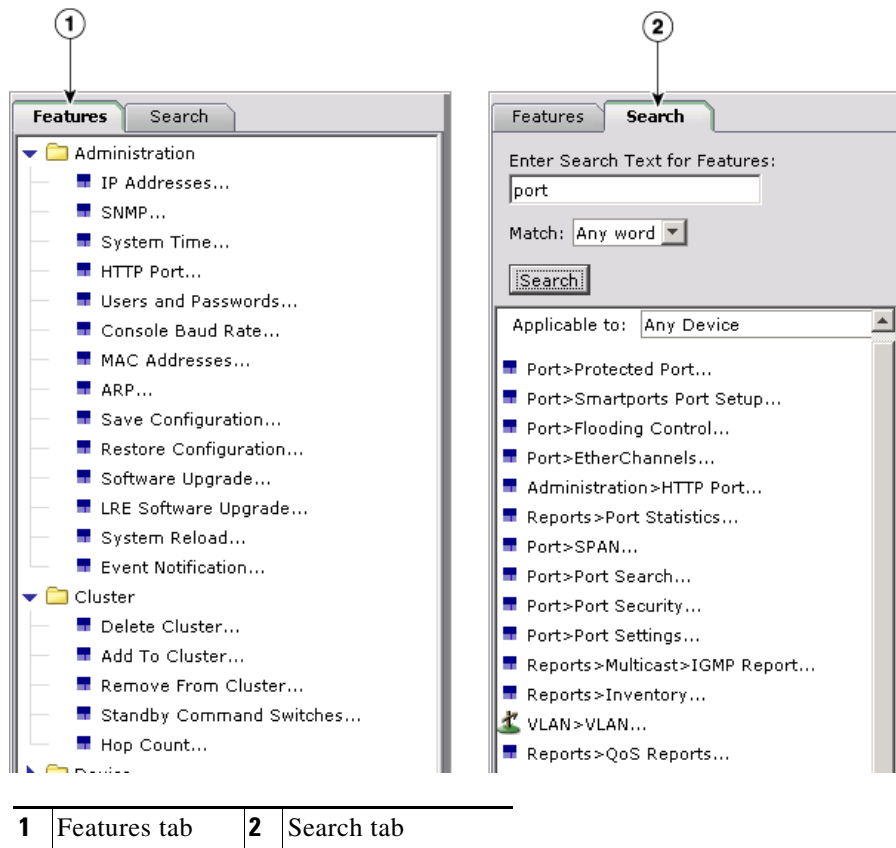

Note

Only features supported by the devices in your cluster are displayed in the feature bar.

You can search for features that are available for your cluster by clicking **Search** and entering a feature name, as shown in Figure 3-2.

Access modes affect the availability of features from CMS. Some CMS features are not available in read-only mode. For more information about how access modes affect CMS, see the “[Privilege Levels](#)” section on page 3-7.

Online Help

CMS provides comprehensive online help to assist you in understanding and performing configuration and monitoring tasks from the CMS windows.

Online help is available for features that are supported by devices in your cluster. Sometimes the information in a topic differs for different cluster members. In these cases, the right pane contains all the versions of the topic, each labeled with the host names of the members it applies to.

Online help includes these features:

- Feature-specific help that gives background information and concepts on the features
- Dialog-specific help that gives procedures for performing tasks
- An index of online help topics
- A glossary of terms used in the online help

You can send us feedback about the information provided in the online help. Click **Feedback** to display an online form. After completing the form, click **Submit** to send your comments to Cisco Systems Inc. We appreciate and value your comments.

Configuration Modes

You can change the CMS interaction mode to either expert or guide mode. Expert mode displays a configuration window in which you configure the feature options. Guide mode takes you through each feature option and provides information about the parameter.

Guide Mode

Guide mode is for users who want a step-by-step approach for completing a specific configuration task. This mode is not available for all features. A person icon appears next to features that have guide mode available, as shown in [Figure 3-3 on page 3-6](#).

When you click **Guide Mode** and then select a feature that supports it, CMS displays a specific parameter of that feature and information about the parameter. To configure the feature, you enter the information in each step until you click **Finish** in the last step. Clicking **Cancel** at any time ends the configuration task without applying any changes.

You must click **Guide** *before* selecting an option from the menu bar, tool bar, or popup menu to launch that feature in **Guide Mode**. If you change the interaction mode after selecting a configuration option, the mode change does not take effect until you select another configuration option.

Figure 3-3 Guide Mode and Wizards

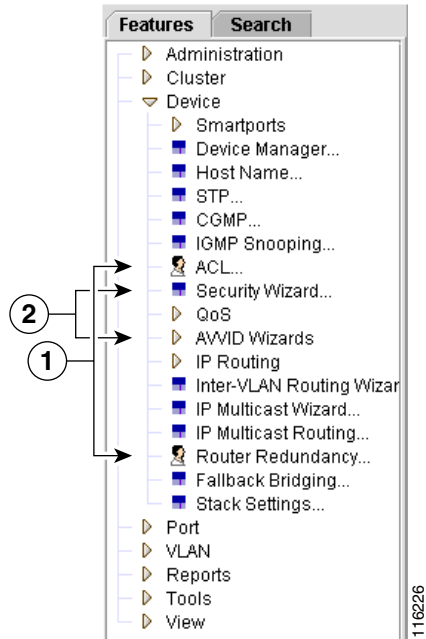

1	Guide mode icon	2	Wizards
---	-----------------	---	---------

Guide mode is not available if your switch access level is read-only. For more information about the read-only access mode, see the “Privilege Levels” section on page 3-7.

Expert Mode

Expert mode is for users who prefer to display all the parameter fields of a feature in a single CMS window. You can view information about the parameter fields by clicking the **Help** button.

You must click **Expert** before selecting an option from the menu bar, tool bar, or popup menu to launch that feature in **Expert Mode**. If you change the interaction mode after selecting a configuration option, the mode change does not take effect until you select another configuration option.

Wizards

Similar to guide mode, wizards provide a step-by-step approach for completing a specific configuration task. Unlike guide mode, a wizard does not prompt you to provide information for all of the feature options. Instead, it prompts you to provide minimal information and then uses the default settings of the remaining options to set up default configurations.

When you select a feature that has *Wizard* in the name, the wizard launches for that feature, as shown in Figure 3-3 on page 3-6.

Wizards are not available for read-only access levels. For more information about the read-only access mode, see the “Privilege Levels” section on page 3-7.

Privilege Levels

CMS provides two levels of access to the configuration options: read-write access and read-only access. If you know your privilege level, you must specify it in the URL that you use to access the cluster. For example, if your privilege level is 13, enter this URL:

```
http://ip_address/level/13/
```

Privilege levels 0 to 15 are supported.

- Privilege level 15 provides read-write access to CMS. This is the default.
- Privilege levels 1 to 14 provide read-only access to CMS. Any options in the CMS windows, menu bar, toolbar, and popup menus that change the switch or cluster configuration are not shown in read-only mode.
- Privilege level 0 denies access to CMS.

If you do not specify a privilege level when you access CMS, the switch verifies whether you have privilege level 15. If you do not, you are denied access to CMS. If you do have privilege level 15, you are granted read-write access. Therefore, you do not need to include the privilege level if it is 15. Entering zero denies access to CMS.

**Note**

You must have privilege level 15 to access CMS through a TACACS+ or RADIUS server.

For more information about privilege levels, see the [“Preventing Unauthorized Access to Your Switch” section on page 7-1](#) and the [“Configuring Multiple Privilege Levels” section on page 7-8](#).

Access to Older Switches in a Cluster

If your cluster has these member switches running earlier software releases and if you have read-only access to these member switches, some configuration windows for those switches display incomplete information:

- Catalyst 2900 XL or Catalyst 3500 XL member switches running Cisco IOS Release 12.0(5)WC2 or earlier
- Catalyst 2950 member switches running Cisco IOS Release 12.0(5)WC2 or earlier

For more information about this limitation, refer to the release notes.

These switches do not support read-only mode on CMS:

- Catalyst 1900 and Catalyst 2820 switches
- Catalyst 2900 XL switches with 4-MB CPU DRAM

In read-only mode, these switches appear as unavailable devices and cannot be configured from CMS.

Configuring CMS

This section contains these topics that describe the requirements and configuration information for CMS:

- “CMS Requirements” section on page 3-8
- “Cross-Platform Considerations” section on page 3-9
- “Launching CMS” section on page 3-11

CMS Requirements

This section describes the hardware and software requirements for running CMS:

- “Minimum Hardware Configuration” section on page 3-8
- “Operating System and Browser Support” section on page 3-9
- “CMS Plug-In” section on page 3-9
- “Specifying an HTTP Port (Nondefault Configuration Only)” section on page 3-10
- “Configuring an Authentication Method (Nondefault Configuration Only)” section on page 3-10



Note

The software requirements are automatically verified by the CMS Startup Report when you launch CMS. For more information, see the “Launching CMS” section on page 3-11.

Minimum Hardware Configuration

The minimum PC requirement is a Pentium processor running at 233 MHz with 64 MB of DRAM. The minimum UNIX workstation requirement is a Sun Ultra 1 running at 143 MHz with 64 MB of DRAM.

Table 3-2 lists the minimum platforms for running CMS.

Table 3-2 Minimum Hardware Configuration

OS	Processor Speed	DRAM	Number of Colors	Resolution	Font Size
Windows NT 4.0 ¹	Pentium 300 MHz	128 MB	65,536	1024 x 768	Small
Solaris 2.5.1 or higher	SPARC 333 MHz	128 MB	Most colors for applications	—	Small (3)

1. Service Pack 3 or higher is required.

Operating System and Browser Support

You can access the CMS interface by using the operating systems and browsers listed in [Table 3-3](#). CMS checks the browser version when starting a session to ensure that the browser is supported.

Table 3-3 Supported Operating Systems and Browsers

Operating System	Minimum Service Pack or Patch	Netscape Communicator	Microsoft Internet Explorer ¹
Windows 98	Second Edition	7.1	5.5 or 6.0
Windows NT 4.0	Service Pack 6 or later	7.1	5.5 or 6.0
Windows 2000	None	7.1	5.5 or 6.0
Windows XP	None	7.1	5.5 or 6.0
Solaris 8 or later	Sun-recommended patch cluster for the OS and Motif library patch 103461-24	7.0	Not supported

1. Service Pack 1 or higher is required for Internet Explorer 5.5.

CMS Plug-In

The CMS plug-in is required to run CMS through your web browser. The plug-in is supported both in Windows environments and on Solaris platforms. For more information about the CMS plug-in, including the URL, refer to the “Software Compatibility” section in the release notes.



Note

If you need to both upgrade your web browser and install the CMS plug-in, you *must* upgrade your browser first. If you install the CMS plug-in and then upgrade your browser, the plug-in is not registered with the new browser.

The plug-in includes a console window that you can use to troubleshoot CMS or to view the CLI commands from CMS. When CMS is running, press **F2** to display or to hide the CMS console. Press **F3** to display or to hide the CLI commands that CMS is sending.

Cross-Platform Considerations

When managing switch clusters through CMS, remember that clusters can have a mix of switch models using different Cisco IOS releases and that CMS in earlier Cisco IOS releases and on different switch platforms might look and function differently from CMS in this Cisco IOS release.

When you select **Device > Device Manager** for a cluster member, a new browser session launches, and the CMS version for that switch appears (Catalyst 1900 and 2820 switches only).

Here are examples of how CMS can differ between Cisco IOS releases and switch platforms:

- The CMS versions in these software releases might appear to be similar but they are not the same as this release. For example, the Topology view in this release is not the same as the Topology view or the Cluster View in these earlier software releases.
 - Cisco IOS Release 12.0(5)WC2 or earlier
 - Cisco IOS Release 12.1(6)EA1 or earlier
 - Cisco IOS Release 12.2(18)SE or later
- CMS on the Catalyst 1900 and Catalyst 2820 switches is referred to as *Switch Manager*. Cluster management options are not available on these switches. This is the earliest version of CMS.

Refer to the documentation specific to the switch and its Cisco IOS release for descriptions of the CMS version.

HTTP Access to CMS

CMS uses the HTTP protocol (the default is port 80) and the default method of authentication (the enable password) to communicate with the switch through any of its Ethernet ports and to allow switch management from a standard web browser.

If you have not configured a specific (nondefault) HTTP port and are using the enable password (or no password) for access to the switch, you can go to the [“Displaying CMS” section on page 3-11](#).

Specifying an HTTP Port (Nondefault Configuration Only)

If you change the HTTP port, you must include the new port number when you enter the IP address in the browser **Location** or **Address** field (for example, `http://10.1.126.45:184` where 184 is the new HTTP port number.) You should write down the port number to which you are connected. Use care when changing the switch IP information.

Configuring an Authentication Method (Nondefault Configuration Only)

If you are *not* using the default method of authentication (the enable password), you need to configure the HTTP server interface with the method of authentication used on the switch.

Beginning in privileged EXEC mode, follow these steps to configure the HTTP server interface:

	Command	Purpose
Step 1	<code>configure terminal</code>	Enter global configuration mode.
Step 2	<code>ip http authentication {enable local tacacs}</code>	Configure the HTTP server interface for the type of authentication you want to use. <ul style="list-style-type: none"> • enable—Enable password, which is the default method of HTTP server user authentication. • local—Local user database as defined on the Cisco router or access server is used. • tacacs—TACACS server is used.
Step 3	<code>end</code>	Return to privileged EXEC mode.
Step 4	<code>show running-config</code>	Verify your entries.

After you have configured the HTTP server interface, display the switch home page, as described in the “[Launching CMS](#)” section on page 3-11.

Displaying CMS

This section provides these topics about displaying CMS:

- “[Launching CMS](#)” section on page 3-11
- “[Front Panel View](#)” section on page 3-14
- “[Topology View](#)” section on page 3-15

Launching CMS

To display the switch home page, follow these steps:

-
- Step 1** Enter the switch IP address in the browser, and press **Enter**.
- Step 2** Enter your username and password when prompted. If no username is configured on your switch (the default), enter only the enable password (if an enable password is configured) in the password field.

The switch home page appears, as shown in [Figure 3-4](#).

Figure 3-4 Switch Home Page

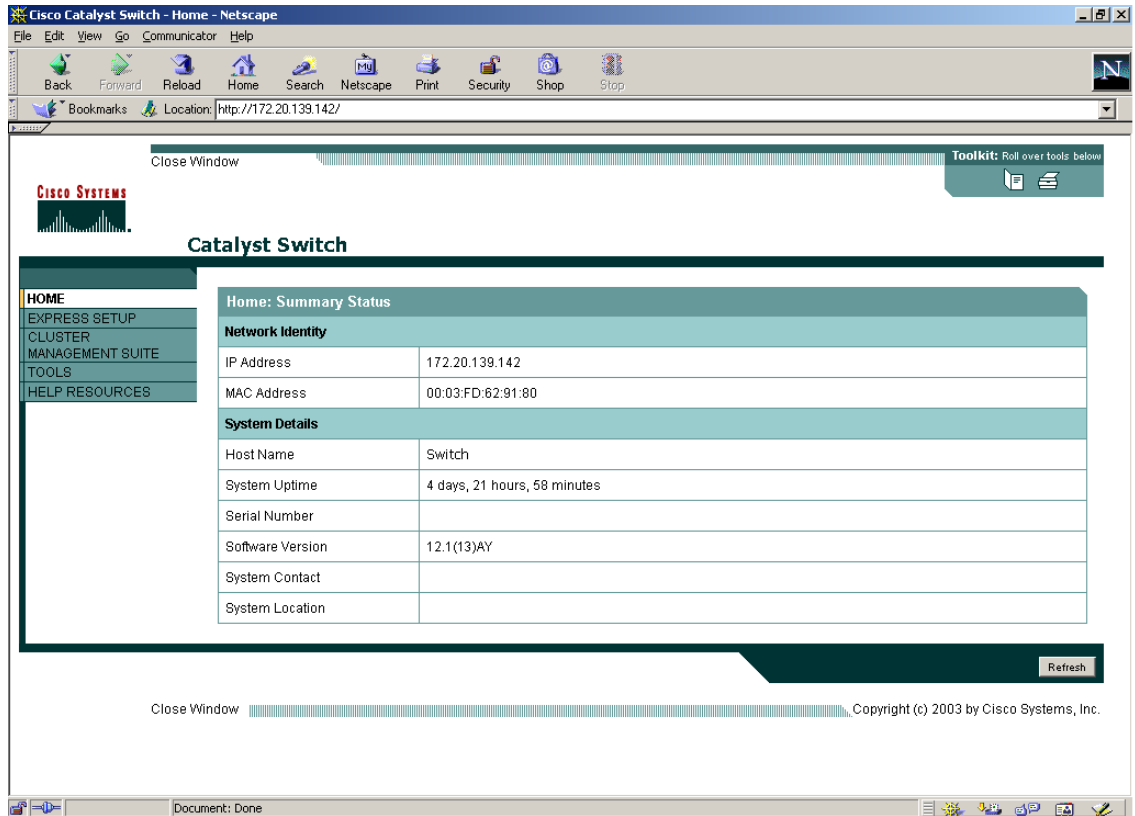

The switch home page has these tabs:

- Express Setup—Opens the Express Setup page



Note

You can use Express Setup to assign an IP address to an unconfigured switch. For more information, refer to the hardware installation guide.

- Cluster Management Suite—Launches CMS
- Tools—Accesses diagnostic and monitoring tools, such as Telnet, Extended Ping, and the **show interfaces** privileged EXEC command
- Help Resources—Provides links to the Cisco website, technical documentation, and the Cisco Technical Assistance Center (TAC)

Step 3 Click **Cluster Management Suite** to launch the CMS interface. The CMS Startup Report runs and verifies that your PC or workstation can correctly run CMS.

If you are running an unsupported operating system, web browser, CMS plug-in or Java plug-in, or if the plug-in is not enabled, the CMS Startup Report page appears, as shown in [Figure 3-5](#).

Figure 3-5 CMS Startup Report

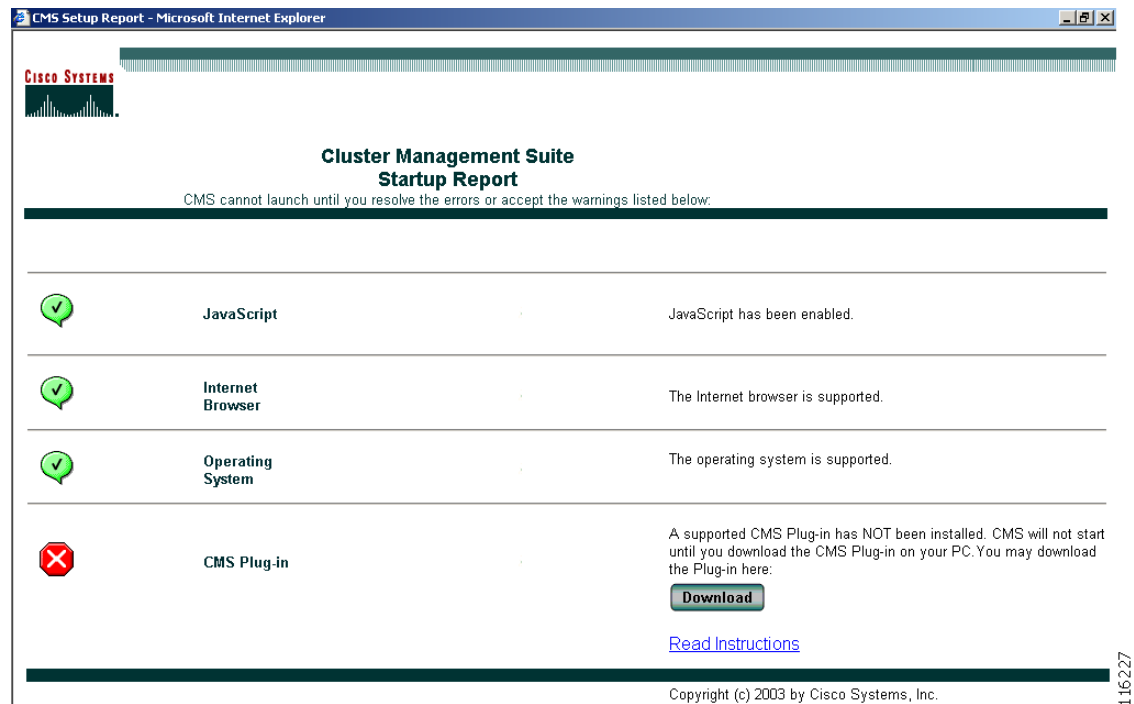

The CMS Startup Report has links that instruct you how to correctly configure your PC or workstation. If the CMS Startup Report appears, click the links, and follow the instructions to configure your PC or workstation.

**Note**

If your PC or workstation is correctly configured for CMS, you do not see the CMS Startup Report.

**Note**

If you are running Windows and need to both upgrade your web browser and install the CMS plug-in, you *must* upgrade your browser first. If you install the CMS plug-in and then upgrade your browser, the plug-in is not registered with the new browser.

When your PC or workstation is correctly configured, CMS launches.

Front Panel View

When CMS is launched from a command switch, you can display the Front Panel view by clicking the Front Panel button on the tool bar, as shown in [Figure 3-6](#).

Figure 3-6 Toolbar



1	Front Panel view button	2	Topology view button
---	-------------------------	---	----------------------

When CMS is launched from a noncommand switch, the CMS Front Panel view displays by default, and the front-panel image displays only the front panel of that switch.

The Front Panel view displays the front-panel image of the command switch and any other switches that were selected the last time the view was displayed.

You can choose and configure the switches that appear in the Front Panel view. You can drag the switches that appear and re-arrange them. You can right-click on a switch port to configure that port.

Figure 3-7 Front Panel View and Port Popup Menu

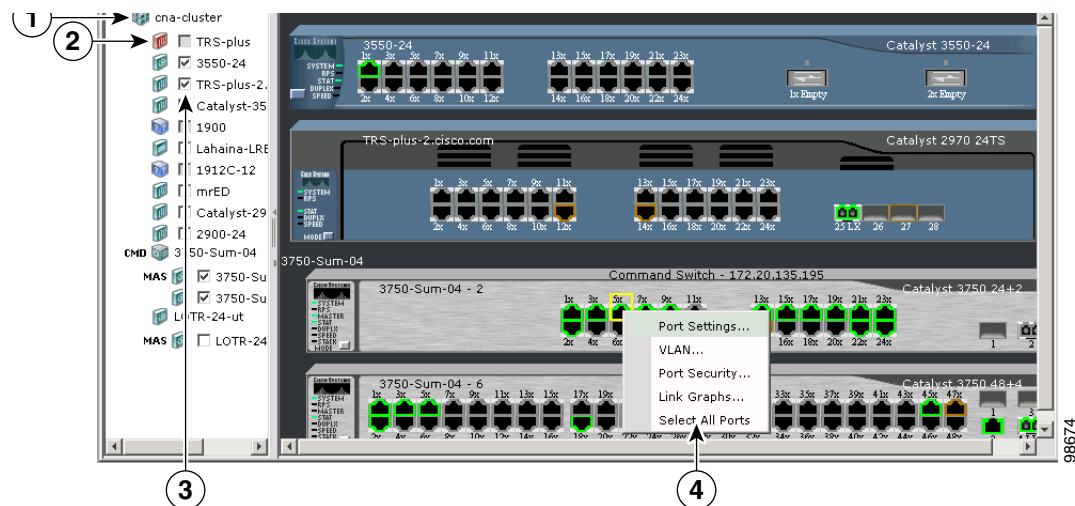

1	Cluster tree	3	Check boxes to show switches
2	Command switch	4	Port settings popup menu

**Note**

Figure 3-7 shows a cluster with a Catalyst 3550 switch as the command switch. Refer to the release notes for a list of switches that can be members of a cluster with a Catalyst 2970 switch as the command switch.

Topology View

When CMS is launched from a command switch, the Topology view appears by default.

When you click the topology button on the tool bar, the Topology view displays the command switch (shown by the *CMD* label) and the devices that are connected to it, as shown in Figure 3-8. You can right-click on a switch or link icon to display a menu for that icon.

Figure 3-8 Topology View and Device Popup Menus

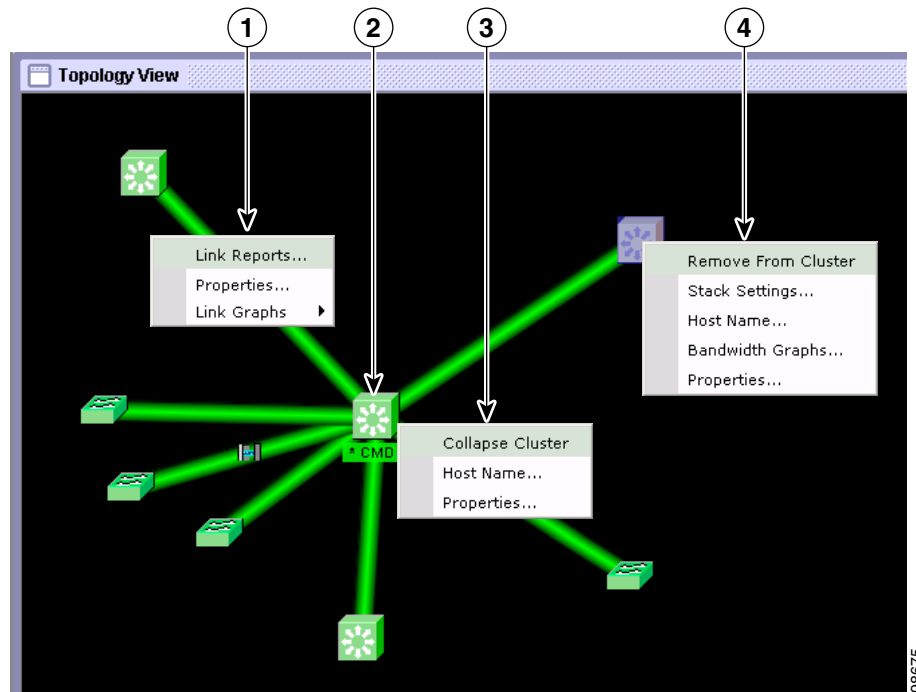

1	Link popup menu	3	Command switch popup menu
2	Command switch	4	Cluster member popup menu

**Note**

Figure 3-8 shows multiple popup menus. Only one popup menu at a time appears in the CMS.

The Topology view shows how the devices within a switch cluster are connected and how the switch cluster is connected to other clusters and devices. From this view, you can add and remove cluster members. This view provides two levels of detail of the network topology:

- **Expand Cluster**—When you right-click a cluster icon and select **Expand Cluster**, the Topology view displays the switch cluster in detail. This view shows the command switch and member switches in a cluster. It also shows candidate switches that can join the cluster. This view does not display the details of any neighboring switch clusters
- **Collapse Cluster**—When you right-click a command-switch icon and select **Collapse Cluster**, the cluster is collapsed and represented by a single icon. The view shows how the cluster is connected to other clusters, candidate switches, and devices that are not eligible to join the cluster (such as routers, access points, IP phones, and so on).

**Note**

The Topology view displays only the switch cluster and network neighborhood of the specific command or member switch that you access. To display a different switch cluster, you need to access the command switch or member switch of that cluster.

CMS Icons

For a complete list of device and link icons available in CMS, select **Help > Legend** from the CMS menu bar.

Where to Go Next

- See [Chapter 5, “Clustering Switches,”](#) for more information about command and member switches.
- See [Chapter 6, “Administering the Switch,”](#) for more information about administrative tasks.
- Select **Administration > Software Upgrade** to upgrade a switch by using HTTP or TFTP.
- Click **Help > What's New?** in the online help for a list of new CMS features in this release.