



## GETTING STARTED GUIDE

**Cisco Small Business**

NSS3000 Series Network Storage System



**Americas Headquarters**  
Cisco Systems, Inc.  
San Jose, CA

**Asia Pacific Headquarters**  
Cisco Systems (USA) Pte. Ltd.  
Singapore

**Europe Headquarters**  
Cisco Systems International BV  
Amsterdam, The Netherlands

Cisco has more than 200 offices worldwide. Addresses, phone numbers, and fax numbers are listed on the Cisco Website at [www.cisco.com/go/offices](http://www.cisco.com/go/offices).

CCDE, CCENT, Cisco Eos, Cisco Lumin, Cisco Nexus, Cisco StadiumVision, Cisco TelePresence, Cisco WebEx, the Cisco logo, DCE, and Welcome to the Human Network are trademarks; Changing the Way We Work, Live, Play, and Learn and Cisco Store are service marks; and Access Registrar, Aironet, AsyncOS, Bringing the Meeting To You, Catalyst, CCDA, CCDP, CCIE, CCIP, CCNA, CCNP, CCSP, CCVP, Cisco, the Cisco Certified Internetwork Expert logo, Cisco IOS, Cisco Press, Cisco Systems, Cisco Systems Capital, the Cisco Systems logo, Cisco Unity, Collaboration Without Limitation, EtherFast, EtherSwitch, Event Center, Fast Step, Follow Me Browsing, FormShare, GigaDrive, HomeLink, Internet Quotient, IOS, iPhone, iQuick Study, IronPort, the IronPort logo, LightStream, Linksys, MediaTone, MeetingPlace, MeetingPlace Chime Sound, MGX, Networkers, Networking Academy, Network Registrar, PCNow, PIX, PowerPanels, ProConnect, ScriptShare, SenderBase, SMARTnet, Spectrum Expert, StackWise, The Fastest Way to Increase Your Internet Quotient, TransPath, WebEx, and the WebEx logo are registered trademarks of Cisco Systems, Inc. and/or its affiliates in the United States and certain other countries.

All other trademarks mentioned in this document or website are the property of their respective owners. The use of the word partner does not imply a partnership relationship between Cisco and any other company. (0809R)

<b>Chapter 1: Introduction</b>	<b>1</b>
Benefits	1
About this Guide	2
Approved Vendor List for Drives	2
	2
<b>Chapter 2: Setting up the Hardware</b>	<b>3</b>
Installing the Disk Drives	3
Connecting the NSS to the Network	6
Connecting the Power	7
Connecting the Chassis to a Standard Power Outlet	7
Connecting the Chassis to an Uninterruptible Power Supply	8
Supported UPS Product Families	8
Starting the NSS	9
Using the NSS3000 LCD Panel	10
<b>Chapter 3: Configuring the NSS</b>	<b>12</b>
Configuring the Computer Network Settings	12
Logging into the Configuration Interface	13
Running the Quick Setup Wizards to Configure the NSS	16
Saving the NSS Configuration	17
<b>Chapter 4: Accessing the Network Storage</b>	<b>20</b>
Windows Users	20
Accessing the Storage using CIFS/SMB	20
Accessing the Storage through FTP	21
UNIX and Linux Users	22
Accessing the Storage through NFS	22
Accessing the Storage through FTP	23

Mac Users	23
Accessing Storage through CIFS/SMB	23
Accessing Storage through FTP	24
<b>Chapter A: NSS LEDs</b>	<b>25</b>
Power Button LED	25
System LED	26
LAN LED	27
Hard Disk Drive LEDs	27
ACT LED	27
ERR LED	28
Reset Button	28
<b>Appendix B: Specifications</b>	<b>29</b>
<b>Appendix C: Additional Information</b>	<b>30</b>
Regulatory Compliance and Safety Information	30
Warranty	30
End User License Agreement (EULA)	30
<b>Appendix D: Support Contacts</b>	<b>31</b>

# Introduction

Thank you for choosing the Cisco Small Business Network Storage System (NSS).

Administering a network can be a difficult job. Finding low-cost ways to simplify your data-management tasks means that you have more resources to dedicate elsewhere. The NSS is a Network Attached Storage (NAS) unit that appears as a native file server for the various clients within your network, including Windows, Apple Macintosh, UNIX, and Linux platforms. The biggest benefit to your users is that they can now access data that might be stored across different physical platforms as simply as if it were on their own computers. The NSS provides a single repository that is completely dedicated to storage, ensuring the integrity, reliability, and accessibility of your data for a relatively low cost.

The NSS lets you install up to four physical disk drives. It uses the most common file-based protocols such as NFS, CIFS, and FTP for file sharing.

## Benefits

The NSS offers these main advantages to your business:

- **Cross-platform file sharing:** Share files easily and inexpensively across multiple platforms over a cost-effective Ethernet and IP network.
- **Easy installation and administration:** With a basic understanding of networking, the NSS is easily configured, managed, and made available to all of the users on your network.
- **Data consolidation:** Centralize data to reduce management costs and maximize your investment in existing hardware. This also means better data security.

---

## About this Guide

This guide provides instructions on how to initially configure your NSS3000. It describes how to set up the hardware, configure the NSS, and how users can access the network storage.

## Approved Vendor List for Drives

If you are purchasing disk drives to install in the NSS, see the Cisco Approved Vendor List at [www.cisco.com/go/smallbiz](http://www.cisco.com/go/smallbiz) for a list of recommended disk drives.

When you select a disk drive, consider the type of RAID levels required to service your business needs. For example, if you are creating a RAID (versus a JBOD), make sure that each of the disks used in the array have the same disk capacity. The RAID is built using the capacity of the smallest disk in the array.

## Setting up the Hardware

This chapter provides instructions for installing the NSS hardware. It describes how to physically install the NSS and how to use the LCD panel of the front of the chassis to view the NSS status. It includes the following topics:

- Installing the Disk Drives
- Connecting the NSS to the Network
- Connecting the Power
- Starting the NSS
- Using the NSS3000 LCD Panel

### Installing the Disk Drives

Follow these steps to install disk drives in the NSS3000 NAS chassis.

If your NSS has the disk drives already installed, skip this step and go to Step 2.

- 
- STEP 1** Remove the contents of the NSS3000 NAS package from the box.
- STEP 2** Place the chassis upright on a flat surface.
- STEP 3** Unlock the front lock of the chassis.



**STEP 4** Open the front door of the chassis.

**STEP 5** From disk bay 1, remove the disk tray.

To remove the tray, push in the tab on the latch on the front of the tray, and then open the latch. Pull out the tray.



**STEP 6** Position the disk drive into a disk tray. Then, attach the disk drive to the tray by inserting the disk drive screws into the four holes at the bottom of the tray and tightening them with a Phillips screwdriver.

Alternatively, you can attach the disk drive to the tray by inserting two screws into the holes on each side of the tray and tightening them.

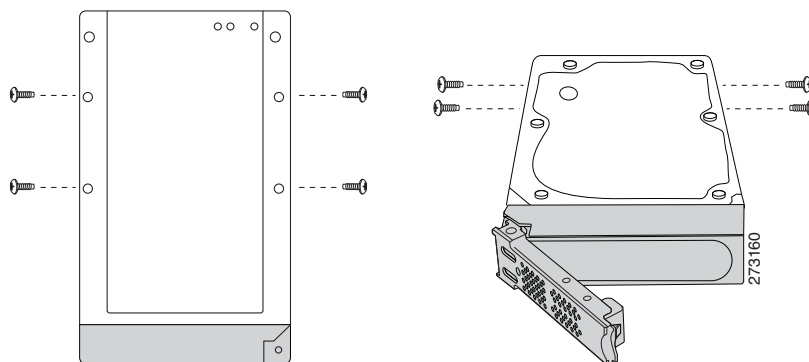

**STEP 7** Insert the tray back into the empty bay of the chassis.

**STEP 8** Apply even pressure to both corners of the tray while you insert the tray fully into position in the chassis. Then, close the latch of the tray.



**STEP 9** Repeat steps 5 through 9 to install additional disk drives.

**STEP 10** Close the front door of the chassis.

**STEP 11** Continue to the next section, [Connecting the NSS to the Network](#).

## Connecting the NSS to the Network

Follow these steps to connect the NSS to the network.

- STEP 1** Connect the supplied Ethernet cable to the Ethernet port on the back of the chassis.
- STEP 2** Connect the other end of the Ethernet cable to a switch or router on your network.

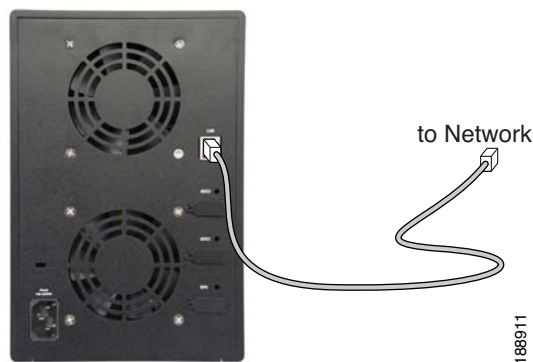

- STEP 3** Make sure the Ethernet connections are secure.
- STEP 4** Continue to the next section, [Connecting the Power](#).



**NOTE** If you are hotplugging an Ethernet cable to the NSS after the initial installation, make sure that you wait 15 seconds between the time you unplug the cable and plug it back in. Within 10 seconds the newly connected link should appear with the correct IP and link rate in the configuration interface.

## Connecting the Power

You can connect the NSS chassis to a standard power outlet or connect it to an Uninterruptible Power Supply (UPS).



**NOTE** We recommend that you use an UPS since a sudden loss of power can cause RAID corruption and possible data loss.

### Connecting the Chassis to a Standard Power Outlet

Follow these steps to connect the chassis to a standard power outlet.

**STEP 1** Connect one end of the supplied power cable to the Power port on the chassis.

**STEP 2** Connect the other end of the power cable to a standard power outlet.



## Connecting the Chassis to an Uninterruptible Power Supply

To protect data against a sudden loss of power, follow these steps to connect the chassis to an Uninterruptible Power Supply (UPS).

- STEP 1** Connect one end of the supplied power cable to the Power port on the NSS3000 chassis.
- STEP 2** Connect the other end of the power cable to the UPS.
- STEP 3** Use a USB signal cable to connect the UPS port on the chassis to the UPS.

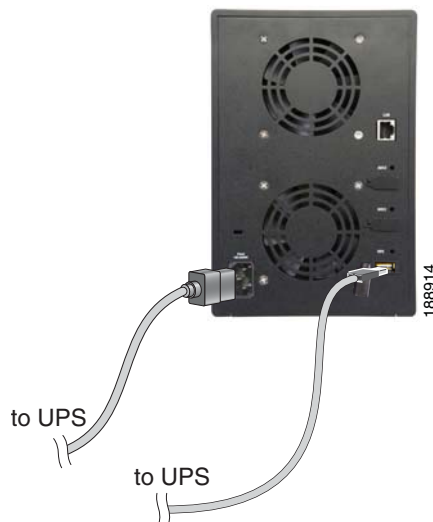

## Supported UPS Product Families

The NSS supports these UPS product families:

- APC Back-UPS Pro USB
- APC Back-UPS RS USB
- APC Back-UPS USB
- APC Back-UPS LS USB
- APC Back-UPS ES/CyberFort 350
- APC Smart-UPS USB

## Starting the NSS

Follow these steps to start the NSS.

- STEP 1** Press the **Power** button on the front of the chassis.



- STEP 2** Verify that the **Power** LED on the front of the NSS chassis turns yellow. If the LED is not yellow, see the "Power Button LED" section on page 25.
- STEP 3** Confirm that the LCD display on the front of the chassis displays the IP address assigned to the chassis. See "Using the NSS3000 LCD Panel" on page 10.

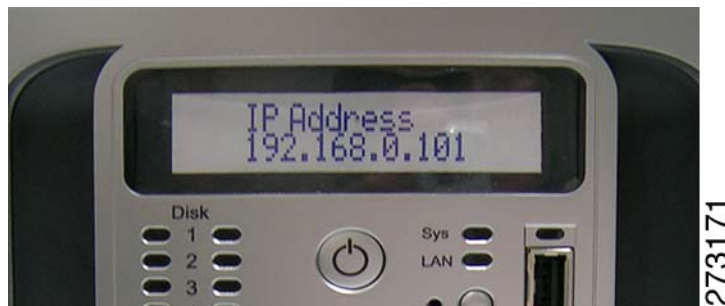

- STEP 4** If the IP address assigned to the chassis starts with 169.254, it means that the address is self-assigned. This happens if there is no DHCP server on the network



- CAUTION** If you disconnect and reconnect the chassis (while it is turned on) from or to the network, you must wait 15 seconds before you can access the chassis through the network.

- STEP 5** The hardware installation is complete.

Continue to "Configuring the NSS," on page 12.

## Using the NSS3000 LCD Panel

The LCD panel on the front of the chassis let you view various aspects of the system such as the status of the configured RAIDs, volumes, the status of the bootup, and so on. To see the available options, press the **Display** button. Each time you press the **Display** button, the next screen appears. Subsequent pages appear after a few seconds and continue to automatically scroll through the pages until you press the **Display** button again.



**NOTE** Because of the screen space limitations within many of the available screens, the information appears on multiple pages. For example, the **Home** screen has two pages (page 1 shows the hostname and IP, and the second page shows the hostname and netmask).

The LCD panel displays these screen options:

- **Bootup Screen:** During the bootup of the NSS, the LCD panel displays its progress.
- **Home Screen:** Displays the current hostname, IP address, and netmask of the system.
- **System Alerts:** Displays the system alerts (two per page) in order from most recent to the oldest. (For details about the system alerts, refer to the System Alerts section on the System Status page.)
- **RAID Status:** Displays details for the configured RAID arrays in the system. You can view the type of the RAID array (J=JBOD, 0, 1, 5, 10), the state of the RAID (i.e., clean, degraded, rebuild, failed, and stopped), and the percentage complete of the RAID rebuild (if currently in progress).
- **Volume Status:** Displays the configured volumes and the percentage of space used. Each volume appears with the RAID on which it is configured followed by the volume name. For example, A:volB (which indicates that Volume B is located on RAID A).
- **Cable Diagnostics:** Displays the status of the Ethernet cable. If the link is working properly, the link status appears as **OK**. If there is a problem with the link, the status is reported according to the pairs within the cable. These messages can appear:

- **Short:** If the pair has a short, the message appears as "pair a-b short@ Xm" (where "a" and "b" are the numbers of the pair, "X" is the location in the cable where the short was found, and "m" stands for metres).
- **Open:** If the cable has an open, the message appears as "pair a-b open@ Xm" (where "a" and "b" are the numbers of the pair, "X" is the location in the cable where the open was found, and "m" stands for metres).
- **Disconnected:** If the cable shows an open at the minimum measurable distance, it is assumed that the cable is not connected. The message "Cable is not connected" appears.

The cable diagnostic test only runs the first time you display the **Cable Diagnostics** screen. To rerun the test, scroll through the LCD screens until you see the **Cable Diagnostics** screen appear again.

- **Firmware Version/Update Date:** Displays the version of the firmware and the date that the last firmware upgrade was completed.
- **Firmware Upgrade:** Displays the progress of the firmware upgrade. When you display this screen, a diagnostic test is automatically run (This screen only appears when performing a firmware upgrade)
- **System Time/Date:** Displays the current time and date for the system. The time appears using the 24-hour clock. The date appears as the day of the week, the month as a three-character abbreviation, and the year. For example, 21:45, Wed, Dec 12, 2008.
- **Shutdown Screen:** During the shutdown of the NSS, the LCD panel displays the progress of the shutdown.
- **Network Factory Defaults Restore:** During the restoration of the default network configuration the LCD panel displays that the network is being restored and is changing the settings to the default settings.

## Configuring the NSS

This chapter describes the steps you need to follow to configure the NSS, and includes the following topics:

- [Configuring the Computer Network Settings](#)
- [Logging into the Configuration Interface](#)
- [Running the Quick Setup Wizards to Configure the NSS](#)
- [Saving the NSS Configuration](#)

For a detailed description of the configuration options available, see the *NSS3000 Series Network Storage System Administration Guide* available on Cisco.com at [www.cisco.com/go/smallbiz](http://www.cisco.com/go/smallbiz), or refer to the online help on the NSS configuration interface.

## Configuring the Computer Network Settings

The NSS ships with its network interface configured for DHCP. This is the default configuration. If a DHCP server is installed on your network, skip this step.

If there is no DHCP server on your network, you must manually configure the computer network setting as follows:

- 
- STEP 1** Set the IP address and subnet mask to the following:
- **IP Address** **169.254.x.y**(where *x* and *y* can be any number between 1 and 254). For example, 169.254.200.30. Make sure that you pick an address that is different from the address of the NSS chassis.
  - **Subnet Mask** 255.255.0.0.
- STEP 2** Log into the NSS configuration interface. Configure the NSS network IP settings as required.



**NOTE** The configuration for your computer is only temporary. After you initially open the configuration interface, you can configure the static IP address for the NSS and then restore your computer's network settings to their previous values. For help setting the IP configuration on the NSS, refer to the online help available from NSS configuration interface.:

## Logging into the Configuration Interface

This section describes how to log in to the NSS configuration interface. The NSS configuration interface is a management tool you use to configure the NSS.

If you are logging into the NSS for the first time, write down the MAC address located on the sticker attached to the bottom of the chassis. You will need the MAC address as this is part of the default hostname. Otherwise, skip this step

**STEP 1** Select a login method. There are three ways to log into the configuration interface.

1. Open a web browser on your computer and enter the following URL in the Address field:

- **`http:// <IP_address_of_NSS_unit>`**

Where *<IP\_address\_of\_NSS\_unit>* is the IP address of the NSS3000 NAS chassis, which appears on the LCD display.

You can also access the chassis by entering the following:

- **`http://NAS<MAC_address_of_NSS_unit>`**

Where *<MAC\_address\_of\_NSS\_unit>* is the MAC address of the NSS3000 NAS chassis. The MAC address of the chassis is recorded on a label above the disk drive b

2. Use the **Bonjour** discovery tool (if installed) and select the NSS from the list of available devices.

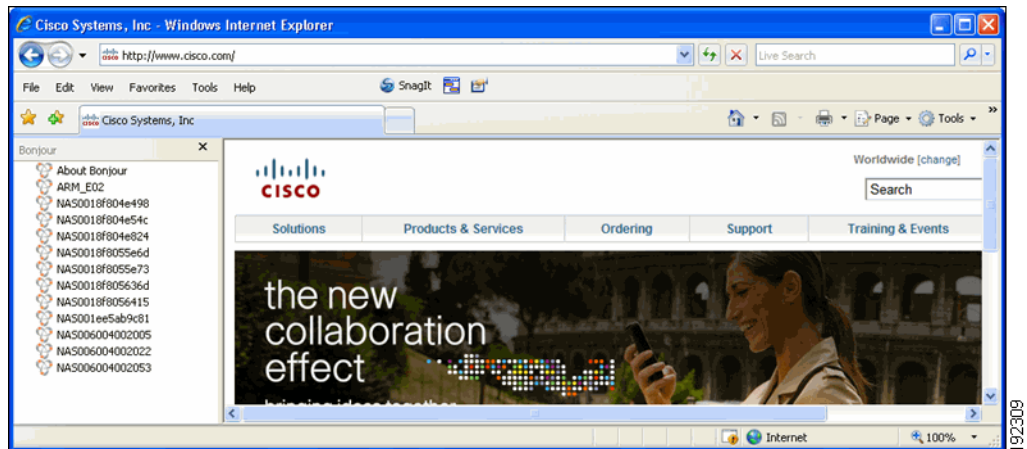

3. Run the **Discovery Tool** from the CD that shipped with your NSS. Insert it into your PC to automatically run the installation tool. (You can also download the **NSS Discovery** application from Cisco.com at: [www.cisco.com/go/smallbiz](http://www.cisco.com/go/smallbiz))

The **Welcome** screen appears.

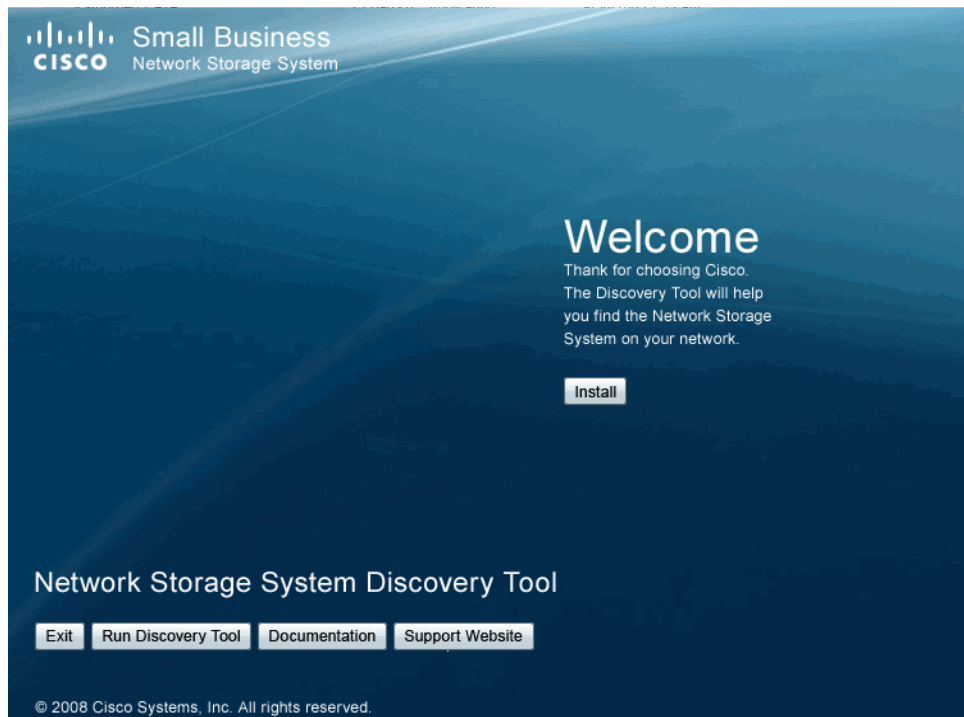

- STEP 1** Click **Run Discovery Tool**.
- STEP 2** From the **Cisco NSS Discovery Tool** window, select the device from the list of NSS devices, and then click **Connect to GUI**.

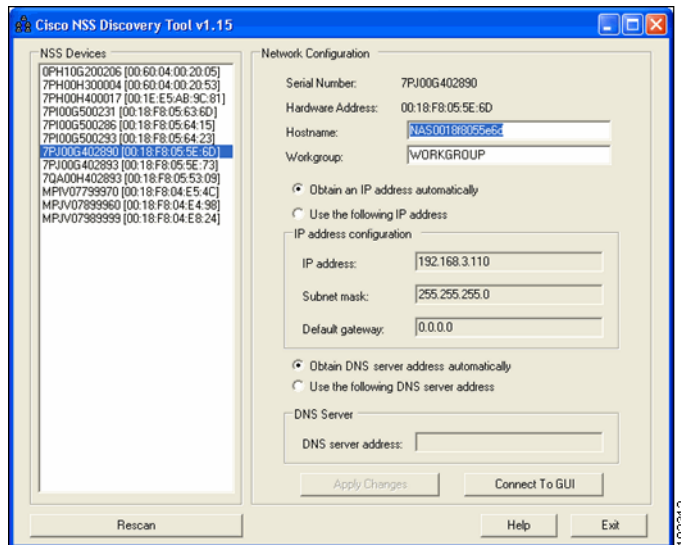

The NSS **Login** window appears.

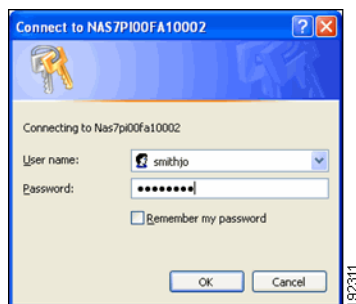

- STEP 3** Enter **admin** in the **User Name** and **Password** fields, then click **OK**. When you first log into the configuration interface or if you reset the factory defaults, both the username and password are set to "admin".
- STEP 4** The setup configuration wizard starts.
- STEP 5** Follow the onscreen instructions to complete the configuration.
- STEP 6** After the configuration completes, change the administration password as described in the *NSS3000 Series Network Storage System Administration Guide*.

## Running the Quick Setup Wizards to Configure the NSS

When you log into the configuration interface for the first time, the **Initial Setup** wizard appears. The setup wizard steps you through the basic configuration to create a RAID, volume, share, user, to set the **Home Directory** location, set the time, and so on. You can access this wizard at any time from the **Manager Menu** of the configuration interface.



**NOTE** if you save any configuration settings before running the wizard, running the wizard will erase any saved data. For example, if you configure a RAID and then run the wizard, the RAID will be deleted.

These wizards are also available from the **Manager Menu** of the configuration interface. Select the wizard and then follow the onscreen instructions.

- **IP Camera Options (Optional):** You can run either the FTP or CIFS wizards to set up the NSS to store videos from IP surveillance cameras. The type of wizard you choose depends on the way the camera transfers the video clips. Before you run the wizard make sure that you create a RAID array, a volume, and add any users that you want to grant access to the surveillance videos. After running the wizard, map a network drive to the share on the PC running the camera utility and configure the camera utility to save the video to the mapped network drive.



**NOTE** You only need to run the wizard once. You must configure each camera to output the video to the configured share

- **FTP:** Run this wizard if the cameras are set up to transfer motion-triggered clips through FTP. The wizard creates a single user and FTP share for the cameras. The videos are then saved within the FTP share which contains a subfolder dedicated to each camera. After you run the wizard, you must configure each camera to output the video to the configured NSS share. Use the information summarized on the last page of the wizard to set up the cameras through their configuration interface.
- **CIFS:** Run this wizard if the cameras have a Windows utility program that lets you save the streaming video to a local drive (or in this case, the NSS) and then view the video from its saved location. The wizard creates a single user and share for all cameras that are configured to

stream video to the Windows camera utility program. After you run the wizard, you must map the network drive from the PC that runs the Windows utility program to the CIFS share and then set up the utility to save to the mapped network drive.

## Saving the NSS Configuration

You can save a copy of the NSS configuration to use if you need to restore the settings at a later time. When you save the configuration file, it saves a date-stamped version of the current configuration settings to the specified volume on the NSS. You can choose to save the current configuration settings to a specified volume on the NSS or you can save the file to a USB flash device.

To save the current configuration:

- STEP 1** If you are saving the configuration file to a USB flash device, insert a USB flash device into the AUX-1 port on the front panel of the NSS.
- STEP 2** From the **Manager Menu**, click **Admin** → **Configuration**.

The **Configuration Manager** page appears.

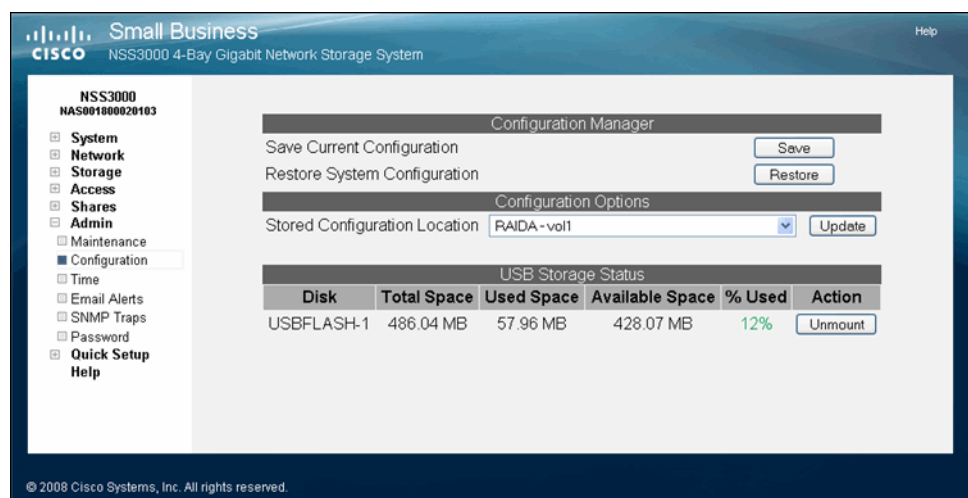

- STEP 3** Select the location where the backup is saved from the **Stored Configuration Location** drop-down menu. To save the configuration file to a USB flash device, select the **AUX-1 port** as the location. You can then copy the configuration file from the USB flash device to another location on your network.

**STEP 4** Click **Update**.

**STEP 5** Click **Save** to save the configuration settings. If you have problems saving the configuration file to the specified volume, check the volume and make sure that it is not locked.

**STEP 6** If you saved the file to the USB flash device, you must unmount the USB device from the AUX-1 port before you remove it. To unmount the device, select **Storage** → **Status** from the **Configuration Manager** window.

The **Storage Status** page appears.

The screenshot displays the Storage Status page for a Cisco NSS3000 4-Bay Gigabit Network Storage System. The page is organized into several sections:

- Disk Status:** A table listing three SATA disks with their ports, models, sizes, health, and status.
- RAID Arrays:** A table showing one RAID array (RAIDA) with a linear RAID level and a size of 1.09 TB.
- Volumes:** A table showing one volume (vol1) located on the RAIDA array, with a total space of 99.98 GB and 560.00 KB of used space.
- USB Storage Status:** A table showing a USB flash device (USBFLASH-1) with a total space of 486.04 MB and 57.96 MB of used space.

The page includes a navigation menu on the left and a footer with the copyright notice: © 2008 Cisco Systems, Inc. All rights reserved.

**STEP 7** Click **Unmount**.

**STEP 8** When the **AUX-1 LED** on the chassis is off, you can safely remove the unmounted USB flash device from the AUX-1 port.

## Accessing the Network Storage

The NSS allows end users running a Windows, UNIX, Linux, or Mac computer to easily access the NSS storage on the network. Once they log into the NSS using their username and password, they can access all the shares to which they have read or read-write privileges. The NSS supports the CIFS, NFS, and FTP file-sharing protocols.

### Windows Users

Windows users who have a user profile set up can access any shares to which they have privileges on the NSS storage using CIFS/SMB or FTP.

#### Accessing the Storage using CIFS/SMB

To access the NSS storage using CIFS/SMB:

- 
- STEP 1** Choose one of these options to access the NSS.
- From the **My Computer** window, type \\<hostname> or \\<IP address> in the Address bar. (Where the <hostname> refers to your NSS hostname and <IP address> refers to your NSS IP address. For example, "\\NAS0123456789ab or \\192.168.1.2".)
  - Browse for the NSS from the **My Network Places** window.
  - Map the NSS to a network drive.

The **Login** window appears.



**STEP 2** If your user profile is set up locally (through the NSS configuration interface) and the NSS is part of a Windows domain, in the **User name** field, enter the following:

**<NSS hostname>\<username>**

If your user profile is set up through the domain or the NSS is not joined to a domain, you do not need to enter the NSS hostname before your user name. (Only enter your user name and password.)

**STEP 3** Click **OK**.

The **Windows Explorer** window opens with a directory listing of the available shares.

**STEP 4** Depending on your share privileges, you can begin using the NSS storage.

## Accessing the Storage through FTP



**NOTE** Before an end user can access the shares on the NSS using FTP, FTP must be enabled on the NSS and the individual share set up to allow FTP access.

To access the NSS storage using FTP:

**STEP 1** From your FTP client application, connect to the NSS. Enter the IP address or hostname of the NSS.

**STEP 2** Enter your username and password when prompted by your FTP client.

When your FTP client logs in, a list of accessible shares appear as individual directories.

**STEP 3** Depending on your share privileges, you can begin using the NSS storage.

## UNIX and Linux Users

UNIX and Linux users who have a user profile set up can access any shares to which they have privileges on the NSS storage using NFS or FTP.

### Accessing the Storage through NFS

UNIX and Linux users can access shares on the NSS through NFS. The NSS3000 only supports NFSv3. For NFS access privileges to work correctly, you must have the NSS joined to an NIS domain.



**NOTE** You must have root privileges to your client system to create an NFS mount. Before an end user can access the shares on the NSS through NFS, NFS must be enabled on the NSS and the individual share set up to allow NFS access.

**STEP 1** Log into the client system as root.

**STEP 2** Create a mount point directory for the mount if you do not already have one (e.g., `mkdir /mnt/nas_share1`).

**STEP 3** Mount the NFS share by entering the following:

```
"mount -v -t nfs -o nfsvers=3,rsize=32768,wsize=32768 <IP address/  
hostname>:<mount point path on NSS> <mount point path on client>"
```

The mount point path on the NSS appears in the **Shares** page located in the configuration interface.

**STEP 4** Log out of the root account.

**STEP 5** Log into the user account on the client system.

**STEP 6** You can now access the share through the mount point directory on your client. You have the share privileges as are defined for the NSS.

---

## Accessing the Storage through FTP



**NOTE** Before an end user can access the shares on the NSS using FTP, the NSS network filters must be set up to allow FTP access. The individual share must be also be set up to allow FTP access.

---

To access the NSS storage using FTP:

---

- STEP 1** Open your FTP client application.
- STEP 2** Enter the NSS hostname/IP address.
- STEP 3** Enter any other required settings. If using FTPS, ensure that the client is set to use Explicit FTPS. For more help using the FTP client, refer to the FTP client documentation.
- STEP 4** Enter your username and password when prompted by the FTP client.
- STEP 5** Depending on your share privileges, you can begin using the NSS storage.

## Mac Users

Mac users who have a user profile can access any shares to which they have privileges on the NSS storage using CIFS/SMB or FTP.

### Accessing Storage through CIFS/SMB

To access the NSS storage though CIFS/SMB:

---

- STEP 1** From the **Finder's Go** menu, click **Connect to Server**.
- STEP 2** Enter "smb://<hostname or IP address of the NSS>/<sharename>". (Where the information in the brackets is meant to be replaced with the applicable information. Do not type the brackets.)
- STEP 3** Click the "+" sign to save the NSS address to the Favorite Servers list so that the next time you log in you just need to select the address from the list.
- STEP 4** Click **Connect**.

- STEP 5** When the **Login** window appears, enter your username and password. If your user profile is set up locally (through the NSS configuration interface and not through the ADS or NTV4 domain) and the NSS is joined to a domain, enter the following:

**<NSS hostname>\<user name>**

If the NSS is not joined to a domain, only enter the username.

- STEP 6** Depending on your share privileges, you can begin using the NSS storage.

### Accessing Storage through FTP



**NOTE** Before an end user can access the shares on the NSS through FTP, the NSS must have FTP access enabled and the individual share must be set up to allow FTP access.

To access the NSS storage using FTP:

- STEP 1** Open your FTP client application.
- STEP 2** Click **Connect**.
- STEP 3** From your FTP client application, connect to the NSS. Enter the IP address or hostname of the NSS. For more information about using your FTP client application, refer to its documentation.
- STEP 4** Enter your username and password when prompted by your FTP client.
- STEP 5** When your FTP client has logged in, a list of accessible shares appears as individual directories.
- STEP 6** Depending on your share privileges, you can begin using the NSS storage.

## NSS LEDs

You can use the NSS LEDs on the front of the NSS chassis to monitor NSS activity and performance. The LEDs also help you troubleshoot a variety of conditions on the NSS, from normal operating conditions, alerts, to serious error conditions.

### Power Button LED

The **Power Button LED** shows whether the NSS is receiving power and is functioning properly. These are the LED colors and their meanings:

- **Solid Yellow:** The NSS is powered on and the boot loader is currently running. The boot loader runs for approximately 10 seconds when the NSS first starts up, and then the LED blinks green.

This condition also occurs if the upgrade of the firmware process fails (although in this case, the LED remains in a solid yellow condition until the user clicks **OK** from the **System Details** page following an unsuccessful upload. After the user clicks **OK**, the system reboots using the current version of the firmware.

- **Blinking Yellow:** The network configuration factory defaults are being reset. When resetting the network defaults, hold down the **Reset** button until you see the **Power** LED flash yellow rapidly.
- **Solid Green:** The NSS is powered up and finished booting.
- **Blinking Green:** The NSS is either booting up or shutting down.
- **Alternating Yellow & Green:** The firmware update is currently in progress.
- **Off:** The NSS is either disconnected from a power source or has finished the shutdown process and can be safely disconnected from a power source.

You can also use the **Power** button LED to perform a graceful shutdown or hard shutdown of the NSS:

- **To perform a graceful shutdown:** Press the **Power** button and hold for about 1 to 2 seconds to trigger a graceful shutdown of the NSS.
- **To perform a hard shutdown:** Press the **Power** button and hold for about eight seconds. Choose this option only if the NSS is not responding to a graceful shutdown.

## System LED

The **System (SYS)** LED indicates that a system error has occurred on the NSS. These are the LED colors and their meanings:

- **Solid Yellow:** Indicates one of these error conditions. You can view the error through the NSS configuration interface.
  - A volume is more than 90% full.
  - A disk drive has failed or is about to fail.
  - A fan has stalled.
  - The system temperature is above the maximum threshold.
  - The temperature of a disk drive is above the maximum threshold.
  - A voltage rail is above or below specification.
  - The NSS is running on UPS due to a mains power failure.
- **Solid Red:** Indicates a critical system failure. The system could not boot due to a corrupted firmware image.
- **Off:** There are no system-related problems.

---

## LAN LED

The **LAN LED** shows the status of the Ethernet link. These are the LED colors and their meanings:

- **Solid Green:** The LAN link is up and running at 1000 link speed, but is currently idle.
- **Flickering Green:** The LAN link is up and running at 1000 link speed and is currently active. The LED flickers off with activity.
- **Solid Yellow:** The LAN link is up and running at 10/100 link speed, but is currently idle.
- **Flickering Yellow:** The LAN link is up and running at 10/100 link speed and is currently active. The LED flickers off with activity.
- **Off:** No LAN link is detected.

## Hard Disk Drive LEDs

The **ACT** and **Error** LEDs show the status of the installed disk drives.

### ACT LED

The **ACT** LED states indicates drive activity. These are the LED colors and their meanings.

- **Solid Green:** The disk drive is configured but is currently idle.
- **Flickering Green:** The disk drive is configured, active, and not rebuilding. Flickers off with activity.
- **Blinking Green:** The disk drive is configured and a RAID array is currently rebuilding to the disk drive.
- **Off:** The disk drive is not configured (not part of a RAID or JBOD array and not exported).

## ERR LED

The **ERR** LED states indicates that the disk drive is in an error condition. These are the LED colors and their meanings

- **Solid Red:** The disk drive is in a failed state.
- **Blinking Red:** The disk drive is predicated to fail (via S.M.A.R.T.). We recommend that you replace the disk drive to avoid the loss of data.
- **Off:** The drive is OK.

**Off:** There is either no UPS attached to the NSS or the UPS function has been disabled in the **System Power** page in the configuration interface.

**On:** A UPS is attached to the NSS and the UPS function is enabled in the **System Power** page in the configuration interface.

For more information about the UPS, see the *NSS3000 Series Network Storage System Administration Guide* available on Cisco.com.”

## Reset Button

Use the **Reset** button to restore the network setting system defaults or to reset the box. The **Reset** button is located to the left of the display button on the front panel of the NSS. You might need to use a pen or the end of a straightened paperclip to press the button.

- **To restore the network setting system defaults**

Shut down the NSS, press the **Reset** button, and then power up the NSS. When you see the **Power** LED blink yellow rapidly, release the **Reset** button. The network settings are restored to the factory defaults.

- **To reset the NSS**

Press and hold the **Reset** button while the system is running until the **Power** LED blinks green. Release the **Reset** button.

# Specifications

## NSS3000

<b>Device Dimensions</b>	3.23 x 11.38" x 9.21" (82 x 289 x 234 mm)
<b>Unit Weight</b>	7.28 lb. (3.3 kg)
<b>Power</b>	60W, 100 to 240VAC
<b>Certification</b>	FCC Class B
<b>Operating Temp</b>	41 to 104°F(5 to 40°C)
<b>Storage Temp</b>	-4 to 158°F(-20 to 70°C)
<b>Operating Humidity</b>	10 to 90%, Relative non-condensing
<b>Storage Humidity</b>	10 to 95%, Relative non-condensing



## Additional Information

This appendix includes Regulatory Compliance and Safety information, warranty, and licensing information for your product. These documents are also available as PDFs on the CD-ROM that shipped with your product.

### Regulatory Compliance and Safety Information

Regulatory Compliance and Safety Information for this product is available on the CD that ships with your product and is also available on Cisco.com at the following location:

[www.cisco.com/go/smallbiz](http://www.cisco.com/go/smallbiz)

### Warranty

Warranty information that applies to this product is available on Cisco.com at the following location:

[www.cisco.com/go/smallbiz](http://www.cisco.com/go/smallbiz)

### End User License Agreement (EULA)

Licensing information that applies to this product is available on Cisco.com at the following location:

[www.cisco.com/go/smallbiz](http://www.cisco.com/go/smallbiz)



## Support Contacts

Support contact information for this product is available on Cisco.com at the following location:

[www.cisco.com/go/smallbiz](http://www.cisco.com/go/smallbiz)