

Router Card Maintenance

This chapter explains how to maintain your router card and contains the following information:

- Removing the router card
- Setting the jumpers
- Changing the system-code SIMM
- Changing the primary-memory DRAM SIMM
- Troubleshooting the router card



Warning Before working on the Cisco 2517 or Cisco 2519, turn OFF the power and unplug the power cord. Do not touch the power supply when the power cord is connected. Line voltages are present within the power supply even when the power switch is OFF and the power cord is connected. Do not work on the system or connect or disconnect cables during periods of lightning activity. Translated versions of this warning message are in the appendix “Translated Safety Warnings.”

Removing the Management Card Tray

Jumpers on the router card are factory set to their default settings and in most cases will not need to be changed. However, if you need to change the jumpers, or upgrade the SIMMs, perform the following steps to remove the management card tray from the chassis.

Step 1 Disconnect any cables attached to the hub port card, management card, or router card.

Removing the Management Card Tray

- Step 2** Loosen the two screws that secure the plastic cover to the front of the chassis, and remove the cover.
- Step 3** Remove the four screws that secure the management card tray to the chassis. (See Figure C-1.)

Figure C-1 Removing the Management Card Tray Screws

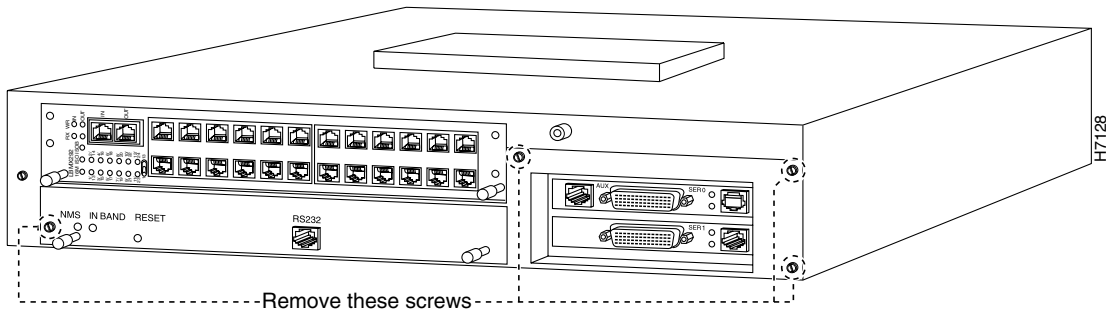

- Step 4** Grasp the extraction posts located on the card and pull forward until the card releases.
- Step 5** Gently pull the tray out along the card guides. See Figure C-2.

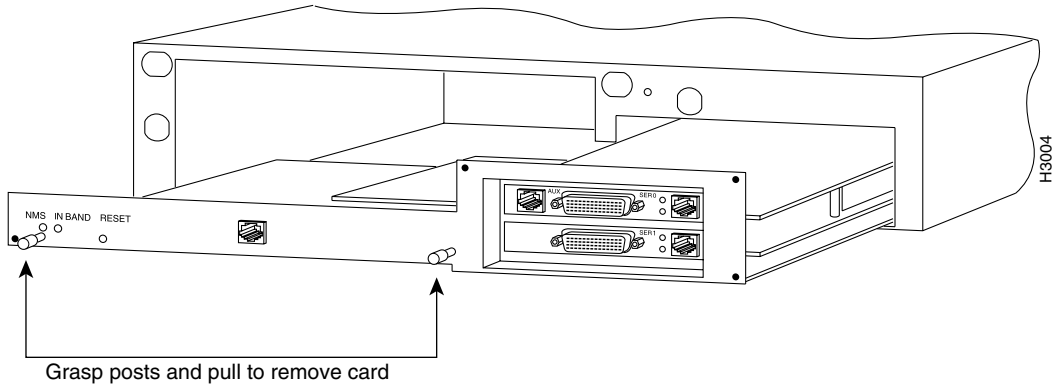
Figure C-2 Removing the Management Card Tray

Note If you are changing jumper settings or replacing SIMMs, do not remove the router card from the ISA slots. Go to the section “Router Card Jumper Settings,” “Changing System-Code SIMMs,” or “Changing Your Primary Memory DRAM SIMMs.”

Router Card Jumper Settings

Jumpers 9, 11, and 13 set the function of the AUX port to either auxiliary (the default setting) or console. See Table C-1 for the AUX port jumper settings. Other jumpers set the COM port, IRQ setting, and shared memory base address. See Table C-2, Table C-3, and Table C-4.

Figure C-3 Router Card Jumper Locations

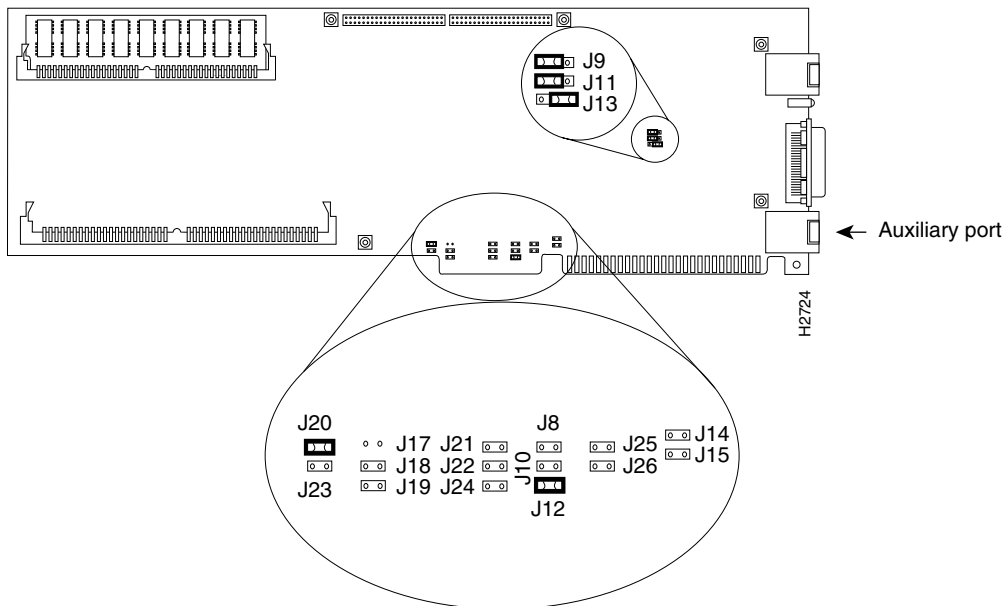

Table C-1 AUX Port Jumper Settings

Jumper	Normal AUX Function (Default)	AUX Port Redirected to CON Port
J9	Jump pins 1-2	Jump pins 2-3
J11	Jump pins 1-2	Jump pins 2-3
J13	Jump pins 2-3	Jump pins 1-2

Table C-2 COM Port Selection Jumper Settings

J18	J19	Port Selection
Out	Out	COM4 (default)
In	Out	COM3
Out	In	COM2
In	In	COM1

Table C-3 COM Port IRQ Jumper Settings

J20	J23	IRQ Selection
In	Out	IRQ3 (COM2 and COM4, default)
Out	In	IRQ4 (COM1 and COM3)
Out	Out	Disabled

Table C-4 Shared Memory Base Address Jumper Settings

J10	J12	J14	J15	Base Address
In	Out	In	Out	\$A0000
Out	Out	In	Out	\$B0000
In	In	Out	Out	\$C0000
Out	In	Out	Out	\$D0000 (default)
In	Out	Out	Out	\$E0000
Out	Out	Out	Out	\$F0000

Changing System-Code SIMMs

The system code (software) is stored in a Flash memory or programmable read-only memory (PROM) SIMM. The 80-pin Flash memory or PROM SIMM is provided in an ESD-protective bag within the shipping container.

Updates for your system code are available for download from a TFTP server or with a system-code SIMM replacement.

Tools and Equipment Required

The following tools are required to change the system-code SIMM in your router card:

- Flat-blade screwdriver
- ESD-preventive wrist strap with an installed alligator clip
- System-code SIMM for the router card

Note The system-code SIMM for the router card is available only from Cisco Systems, Inc. Contact your Cisco customer service representative for more information.

System-Code SIMM Replacement

Following is the procedure for upgrading the system-code SIMM:

- Step 1** Remove the management card tray as described in the section, “Removing the Management Card Tray” earlier in this appendix.
- Step 2** Attach an ESD-preventive wrist strap (see the section “Preventing Electrostatic Discharge Damage” in the chapter “Preparing for Installation”).
- Step 3** Locate the system-code SIMM on the card (see Figure C-4).
- Step 4** Remove the existing system-code SIMM by pulling outward on the connectors to unlatch them. The connector holds the SIMM tightly, so be careful not to break the holders on the SIMM connector. (See Figure C-5.)



Caution To prevent damage, do not push on the center of the SIMMs. Handle each SIMM with care.

Figure C-4 Locating the SIMM Sockets

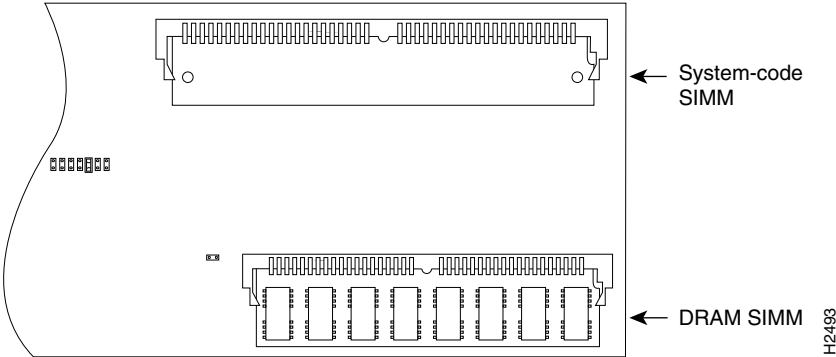
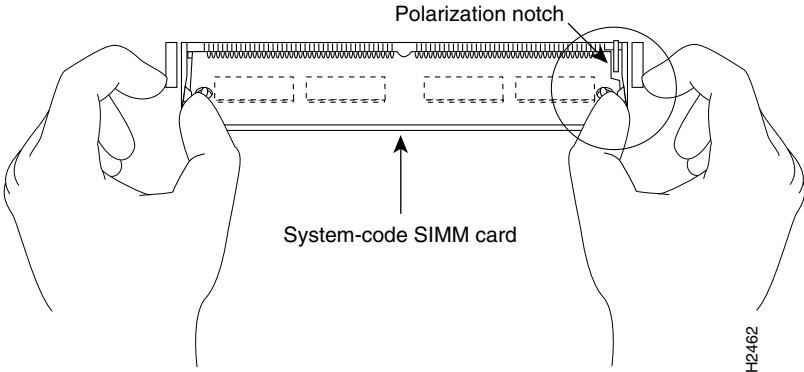
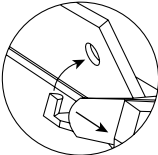

Figure C-5 Removing and Replacing the System-Code SIMM

Pull the tabs away from each other with your thumbs, bracing your forefingers against the posts. Raise the SIMM to a vertical position.



- Step 5** Orienting the router card as shown in Figure C-6, position the new SIMM so that the polarization notch is located at the right end of the SIMM socket.

Figure C-6 Orientation for SIMM Installation

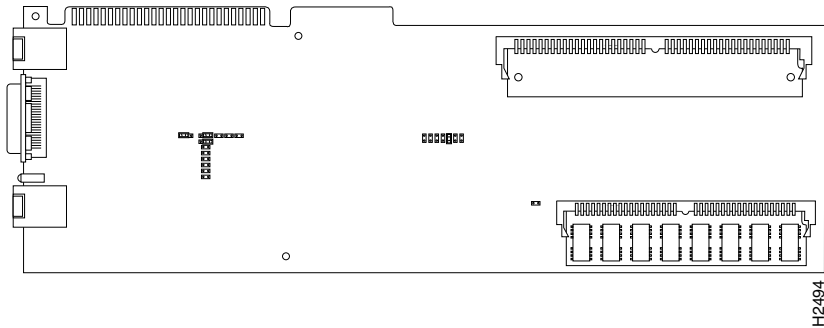

Caution To prevent damage, note that the system-code SIMM has the components mounted on the rear side. Therefore, when you insert the SIMM, always use the polarization notch as a reference and *not* the position of the components on the SIMM.

- Step 6** Insert the new SIMM by sliding the end with the metal fingers into the SIMM connector socket at approximately a 45-degree angle to the router card. Gently rock the SIMM back into place until the latches on both sides snap into place. Do not use excessive force because the connector could break.
- Step 7** Replace the management card tray in the chassis, and secure it with the four screws.
- Step 8** Replace the front cover.

Changing Your Primary Memory DRAM SIMMs

Depending on the level of system features you have chosen for your card (IP only, Desktop, or Enterprise), the router card may be shipped with an additional primary-memory DRAM SIMM. Table C-5 lists approved 70-nanosecond (ns) DRAM SIMMs for the router card.

Table C-5 **Approved DRAM SIMMs**

4-MB Upgrade (1 MB x 36, 70-ns DRAM SIMMs)		16-MB Upgrade (4 MB x 36, 70-ns DRAM SIMMs)	
Manufacturer	Part Number	Manufacturer	Part Number
Micron	MT9D136M-7	Mitsubishi	MH4M36ANXJ-7
NEC	MC421000A36BE-70	–	–

After powering up, your system will indicate in the system banner the amount of primary memory it has. The following example shows a system with 2 MB (2048 KB) of primary memory. (The system does not display shared memory.)

```
System Bootstrap, Version (2.1), SOFTWARE
Copyright (c) 1986-1995 by Cisco Systems
2500 processor with 2048 Kbytes of main memory
>
```

If you use very large routing tables or many protocols, you might need to expand primary memory. This expansion might be necessary with configurations in which the router card is set up as a connection device between large external networks and your internal network.

The feature set you have chosen with your router card may require more than the standard amount of DRAM. The memory requirements for the feature sets are listed in Table C-6.

Table C-6 **Feature Set Memory Requirements**

Feature Set	Small Networks	Large Networks
IP with IBM protocols	2 MB	2 to 18 MB
IP/IPX with IBM protocols	2 MB	2 to 18 MB

Feature Set	Small Networks	Large Networks
Desktop with IBM protocols	6 MB	6 to 18 MB
Enterprise	6 MB	6 to 18 MB

Tools and Equipment Required

The following tools and equipment are required to install DRAM SIMMs in your router card:

- ESD-preventive wrist strap with an installed alligator clip
- The DRAM SIMM appropriate for your router card

DRAM SIMM Installation

Following is the procedure for installing the DRAM SIMM:

- Step 1** Remove the management card tray as described in the section “Removing the Management Card Tray” earlier in this appendix.
- Step 2** Attach an ESD-preventive wrist strap (see the section “Preventing Electrostatic Discharge Damage” in the chapter “Preparing for Installation”).
- Step 3** Turn the management card tray so the router card is oriented in the position shown in Figure C-6, with the DRAM SIMM toward you.
- Step 4** Locate the DRAM SIMM socket on the router card (see Figure C-4).
- Step 5** Remove the existing DRAM SIMM by pulling outward on the connectors to unlatch them. The connector holds the SIMM tightly; take care not to break the holders on the SIMM connector (see Figure C-7).
- Step 6** Using the orientation shown in Figure C-6, position the SIMM so that the polarization notch is located at the right end of the SIMM socket (see Figure C-7).

Figure C-7 Removing and Replacing DRAM SIMMs

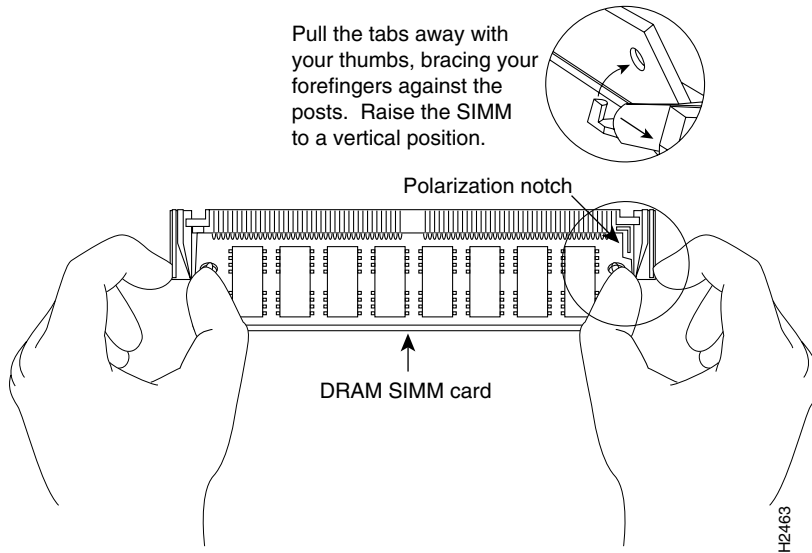

Caution To prevent damage, do not push on the center of the SIMMs. Handle each SIMM with care.

- Step 7** Insert the new DRAM SIMM by sliding the end with the metal fingers into the SIMM connector socket at approximately a 45-degree angle to the router card. Gently rock the SIMM until the latches on both sides snap into place. Do not use excessive force because the connector could break.
- Step 8** Insert the management card tray into the chassis, and secure it with the four screws.
- Step 9** Replace the front cover.

Troubleshooting Your Router Card

Your router card was extensively tested before it was shipped from the factory. Although it is unlikely that the card will exhibit any problems, if your system appears to have problems at startup, read the remainder of this appendix to identify the problem.

Problem Solving

To solve problems in the router card, you need to isolate the problem to a specific source, if possible. By comparing what the router is actually doing to what it should be doing, you can greatly simplify troubleshooting.

When troubleshooting the router card, consider the subsystems of the card:

- Power system

This includes the power supply and the ISA bus system.

- Network interfaces

The LEDs related to your network interface (Token Ring interface and serial WAN) are used to help identify a failure. For information on LED indicators, refer to the following section, “Reading the LED Indicators.”

- System cables

This includes all the interface cables that connect the router card to the network.

Reading the LED Indicators

The router card and the daughter card each have two LED indicators on the interface panel. The upper LED on the main card indicates the activity of the LAN interface on the card. The lower LED on the main card indicates its functional condition.

The upper LED on the daughter card indicates the activity on serial 1 port on the daughter card. The lower LED on the daughter card indicates the activity of the WAN (BRI) port. (see Figure C-8.)

Figure C-8 LED Locations on the Router Card

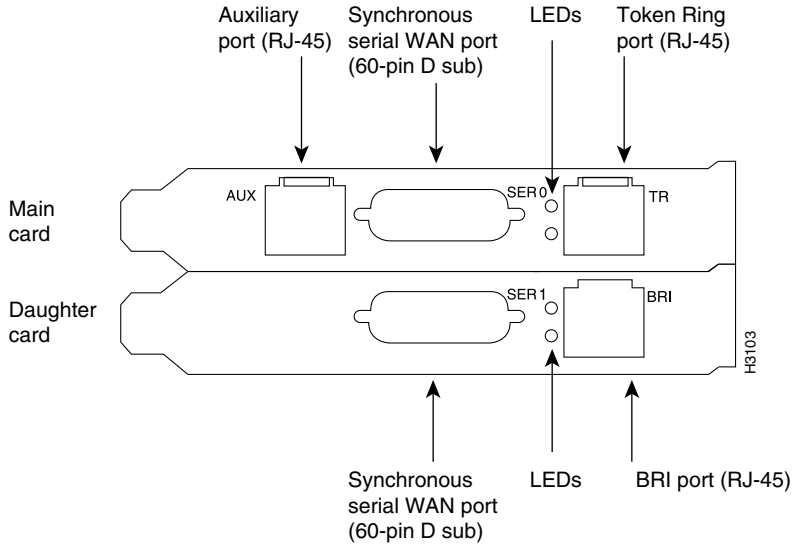

If the interface LED is not on when the interface is active, and the interface is correctly connected, a problem might be indicated. Contact your system administrator. If an interface is extremely busy, its LED will be on all the time. The green OK LED (below the interface LED) will be on after the router card initializes correctly.

Troubleshooting Network Interfaces and Cables

The cables that connect the router card to your network must be securely fastened to provide a trouble-free connection. If you suspect a problem with the cables, check the following conditions and contact your system administrator.

- A network interface is not recognized by the router card.
 - Check the interface cable connection. The Token Ring port on the router card must connect externally to the router port on the hub port card.
 - Check the LED that corresponds to that interface.

- A network interface is recognized, but it will not initialize.
 - Check the interface cable.
- The router card will not boot properly, or reboots constantly or intermittently.
 - This could be a problem with the processor or the software.
- The router card boots, but the console screen is frozen.
 - Check the console baud rate in your terminal emulator. It should be set to 9600 baud.
- Your router card powers on and boots with a particular interface disconnected.
 - Check the network interface connection.

Recovering a Lost Password

If you lose your enable password, or cannot remember it, you can recover it.

Systems running Cisco IOS Release 10.3(2) software or later use the enable secret password, which is encrypted, and therefore cannot be recovered. If you lose your **enable secret** password, you must configure a new one.

Following is the procedure for recovering a lost enable password and configuring a new enable secret password. Before beginning this procedure, you should have terminal emulation software running on your PC.

The password recovery procedure takes place in the following three steps:

- 1 Enter ROM monitor mode.
- 2 Configure a new enable secret password or recover a lost enable password.
- 3 Save the configuration changes you make to NVRAM.

Entering ROM Monitor Mode

Take the following steps to enter ROM monitor mode:

- Step 1** Connect to the Cisco IOS software on the router card. If you use the Cisco 2517 or Cisco 2517 management card console, establish communications with the router card with the following command:

```
ttt -c4 -r -i
```

- Step 2** Enter the command **show version** to display the existing configuration register value. Note this value for later use in Step 4 in the section “Saving Configuration Changes.”

- Step 3** Press **Control-R** to reboot the card.

- Step 4** Within 60 seconds of rebooting the card, press the Break key. This causes the terminal to display the bootstrap program prompt (>).

- Step 5** To reset the configuration register to boot from the boot ROMs and ignore NVRAM, enter the following command at the bootstrap prompt:

```
> o/r 0x041
```

Note A key to recovering a lost password is to set the configuration register so that the contents of NVRAM are ignored (0x0040), which allows you to see your password.

- Step 6** Initialize the router card by entering the following command:

```
> i
```

Recovering a Lost Password

Step 7 The router card will power cycle, the configuration register will be set to 0x141, and the router card will boot the boot ROM system image and prompt you with the system configuration dialog as follows:

```
--- System Configuration Dialog ---
```

Enter **no** in response to the system configuration dialog prompts until the following system message is displayed:

```
Press RETURN to get started!
```

Step 8 Press **Return**. The boot ROM prompt appears as follows:

```
Router (boot) >
```

Step 9 Enter the command **enable** to enter EXEC mode in the boot ROM image. The prompt changes to a pound sign (#):

```
Router (boot) #
```

If you lost an **enable secret** password, follow the steps in the following section “Configuring a New Enable Secret Password.” If you lost an **enable** password, follow the steps in the section “Recovering a Lost Enable Password” later in this chapter.

Configuring a New Enable Secret Password

Take the following steps to configure a new **enable secret** password:

Step 1 Enter the command **configure memory** to save the stored configuration in NVRAM:

```
Router (boot) # conf mem
```

Step 2 Enter the **enable secret** command to configure a new enable secret password and press **Ctrl-Z** to exit configuration mode:

```
Router (boot) # enable secret password  
Router (boot) # ^Z
```

After you have configured the new enable secret password, save your configuration changes by following the steps in the section “Saving Configuration Changes.”

Recovering a Lost Enable Password

Take the following steps to recover a lost **enable** password:

- Step 1** If your password is clear text, enter the EXEC command **show configuration** to display the enable password in the configuration file and to display any **boot system** commands.

```
Router(boot)# show config
```

- Step 2** Locate the enable password command entry in the configuration and record the enable password.

After you have recovered the **enable** password, save your configuration changes by following the steps in the next section, “Saving Configuration Changes.”

Saving Configuration Changes

Take the following steps to save the configuration to NVRAM:

- Step 1** Enter the command **copy running-config startup-config**:

```
Router(boot)# copy running-config startup-config
```



Caution Entering the command **write memory** or **copy running-config startup-config** at this point will override the configuration. Make certain you have a backup copy of your configuration file.

- Step 2** Enter the command **configure terminal** at the EXEC prompt. You are prompted as follows:

```
Router(boot)# conf term  
Enter configuration commands, one per line.  
Edit with DELETE, CTRL/W, and CTRL/U; end with CTRL/Z
```

- Step 3** Enter **no** in response to any **boot system** command in the configuration file.

Recovering a Lost Password

Step 4 Enter the command **config-register 0xvalue** to change the configuration register value back to its original value (noted from Step 2 in the section “Entering ROM Monitor Mode”). The factory default is 0x2102.

```
config-register 0x2102
```

Step 5 Press **Ctrl-Z** to exit configuration mode.

Step 6 Reboot the router/hub and, if required, use the recovered **enable** password to enable the card.