



# CHAPTER 2

## Procedures and Provisioning

---



### Note

The terms "Unidirectional Path Switched Ring" and "UPSR" may appear in Cisco literature. These terms do not refer to using Cisco ONS 15xxx products in a unidirectional path switched ring configuration. Rather, these terms, as well as "Path Protected Mesh Network" and "PPMN," refer generally to Cisco's path protection feature, which may be used in any topological network configuration. Cisco does not recommend using its path protection feature in any particular topological network configuration.

---

This chapter provides TL1 procedures and provisioning for the Cisco ONS 15454, ONS 15310-CL, ONS 15310-MA, and Cisco ONS 15600.

- [2.1 Setting up TL1 Communication, page 2-1](#)
- [2.2 Test Access, page 2-5](#)
- [2.3 TL1 Gateway, page 2-26](#)
- [2.4 Ring Provisioning, page 2-30](#)
- [2.5 PCA Provisioning, page 2-31](#)
- [2.6 FTP Software Download, page 2-32](#)
- [2.7 Scheduled PM Report, page 2-40](#)
- [2.8 Bridge and Roll, page 2-41](#)
- [2.9 1:N Low-Density to 1:N High-Density Upgrade, page 2-49](#)
- [2.10 Remote Monitoring-Managed PMs, page 2-50](#)
- [2.11 Rules for Framing Type Autoprovisioning in CTC Versus TL1, page 2-58](#)
- [2.12 Provisioning Rules for Transponder and Muxponder Cards, page 2-59](#)

## 2.1 Setting up TL1 Communication



The period during which a user is logged into the node is called a session. There are three options you can use to open a session (login):

- Cisco Transport Controller (CTC)
- Telnet
- Craft interface

The TL1 password identifier (PID) is masked when accessing a TL1 session using any of these options. When you log out of any of these options, you are closing a session. The ONS 15454 and ONS 15310-CL allow a maximum of 20 (19 Telnet sessions and one craft session) concurrent TL1 sessions using any one or any combination of the options listed above. The ONS 15600 and ONS 15310-MA support a maximum of 20 (18 Telnet sessions and two craft sessions) concurrent TL1 sessions on the customer access panel (CAP). For information about issuing commands to multiple nodes, see the “[2.3 TL1 Gateway](#)” section on page 2-26.

Use the following procedures to open a TL1 session through the CTC, Telnet, or craft interface. In the procedures, the Activate and Cancel User commands are shown in their input format. For more information about these and other commands and messages, refer to the *Cisco ONS SONET TL1 Command Guide*.

## Open a TL1 Session Through CTC

- 
- Step 1** From the PC connected to the ONS node, start Netscape or Internet Explorer.
- Step 2** Enter the IP address of the node that you want to communicate with in the Netscape or Internet Explorer Web address (URL) field.
- Step 3** Log into the CTC. The IP address on the title bar should match the IP address of the node that you entered in [Step 2](#).
- Step 4** When you are logged into CTC, there are two ways to open a TL1 session:
- Click **Tools > Open TL1 Connection**.
  - Click the **Open TL1 Connection** button  on the toolbar.
- Step 5** From the Select Node dialog box, choose the node that you want to communicate with.
- Step 6** Click **OK**.
- A TL1 interface window appears. There are three subwindows in the TL1 interface window: Request History, Message Log/Summary Log, and TL1 request. Type commands in the TL1 request window. You will see responses in the Message log window. The Request History window allows you to recall previous commands by double-clicking them.
- Step 7** Verify that the Connect button is selected (grayed out).
- Step 8** Type the Activate User command in the TL1 request window to open a TL1 session:  
**ACT-USER:[<TID>]:<UID>:<CTAG>::<PID>;**
- Step 9** Press **Enter**.
-  **Note** You must press Enter after the semicolon in each TL1 command, or the command will not be issued.
- 
- Step 10** Type the Cancel User command in the TL1 request window or press the **Disconnect** button to close a TL1 session:  
**CANC-USER:[<TID>]:<USERID>:<CTAG>;**
- Step 11** Press **Enter**.
-

## Open a TL1 Session Through Telnet

To communicate with the ONS network element (NE) using TL1 commands through a Telnet session over a craft interface or a LAN connection, you can choose from two ports:

- Port number 3083 is a Telnet port that uses the Telnet protocol and associated Telnet escape sequences.
- Port number 2361 is an alternative Telnet port.



**Note** Port number 3082 is a raw TCP/IP port; it is not an interactive port and is not recommended for use as an alternate telnet port.

**Step 1** At the DOS prompt, type **cmd** and press **Enter**. (The same steps can also be done from a UNIX prompt).

**Step 2** At the DOS command prompt type:

**Telnet <Node IP Address or Node Name> <Port Number> and press Enter.**

The Node IP address or Node Name refers to the IP address or Node Name of the node you want to communicate with. Port number is the port (2361 or 3083) where TL1 commands are understood. If the connection is successful, a screen appears with a prompt.

**Step 3** Type the Activate User command to open a TL1 session:

**ACT-USER:[<TID>]:<UID>:<CTAG>::<PID>;**



**Note** When the semicolon is typed, the command is issued immediately.

**Step 4** Type the Cancel User command to close a TL1 session:

**CANC-USER:[<TID>]:<USERID>:<CTAG>;**

## Open a TL1 Session Through a Craft Interface (Cisco ONS 15454, ONS 15310-CL, and ONS 15310-MA)

The TCC2/TCC2P, XTC, 15310-CL-CTX, and CTX2500 cards have two built-in interface ports for accessing the ONS 15454, ONS 15310-CL, and ONS 15310-MA respectively. With one RJ-45 LAN connection, you can access the system using a standard browser interface. In the browser interface, you can perform local and remote Operation, Administration, Maintenance, and Provisioning (OAM&P) functions and open a VT100 emulation window to enter TL1 commands. If a browser is not available, you can access the system using a nine-pin EIA/TIA-232 port. The EIA/TIA-232 port supports VT100 emulation such that TL1 commands can be entered directly without a browser. The ONS 15310-MA has two EIA/TIA-232 ports.

**Step 1** Connect the serial cable to the EIA/TIA-232 port on the active TCC2/TCC2P, XTC, 15310-CL-CTX, or CTX2500 card.

**Step 2** Configure the terminal emulation software (HyperTerminal):

- Terminal emulation = **vt100**

- Bits per second = **9600**
- Parity = **None**
- Stop BITS = **1**
- Flow control = **None**

**Step 3** Press **Enter**. An angle bracket prompt (>) appears.

**Step 4** At the > prompt, type the Activate User command to open a TL1 session:

```
ACT-USER:[<TID>]:<UID>:<CTAG>::<PID>;
```



**Note** When the semicolon is typed, the TL1 command is issued immediately.

**Step 5** Type the Cancel User command to close a TL1 session:

```
CANC-USER:[<TID>]:<USERID>:<CTAG>;
```

## Open a TL1 Session Through a Craft Interface (Cisco ONS 15600)

The TSC card has one RJ-45 port of the faceplate. The RJ-45 port allows you to access the system using a standard web browser. You must use the RJ-45 port on the active TSC. While using the web browser, you can perform local and remote OAM&P functions.

If a browser is not available, you can access the system using one of the two EIA/TIA-232 ports on the CAP. Each EIA/TIA-232 port supports VT100 emulation so that you can enter TL1 commands directly without using a web browser. Each EIA/TIA-232 port supports its own TL1 session.

Because the CAP EIA/TIA-232 port is set up as a data terminal equipment (DTE) interface, you must use a 3-pair swapping null modem adapter so that the TXD/RXC, DSR/DTR, and CTS/RTS pins are swapped when connecting to the serial ports. The null modem adapter connects the CAP EIA/TIA-232 port (male configuration) and the serial cable (female configuration). [Table 2-1](#) lists the null modem adapter pin assignments.

**Table 2-1 Null Modem Adapter Pin Assignments**

TSC Signal	From Pin at TSC (DTE)	To Pin at Second DTE
NC <sup>1</sup>	1	NC
RXD	2	3
TXD	3	2
DTR	4	6
GND	5	5
DSR	6	4
RTS	7	8
CTS	8	7
NC	9	NC

1. NC = not connected

- Step 1** Attach a 3-pair swapping null modem adapter to the EIA/TIA-232 port on the CAP.
- Step 2** Connect a serial cable to the null modem adapter, and to the serial port on your PC or workstation.
- Step 3** Complete one of the following:

- If you are using a PC, configure the terminal emulation software (HyperTerminal):
  - Terminal emulation = **vt100**
  - Bits per second = **9600**
  - Parity = **None**
  - Stop BITS = **1**
  - Flow control = **None**
- If you are using a UNIX workstation, connect from X Windows or the terminal using the tip command:

**tip -9600 /dev/ttyb**



**Note** You might need to use **ttya** instead of **ttyb**, depending on where serial cable is connected.

- Step 4** Press **Enter**. A > prompt appears.
- Step 5** At the > prompt, type the Activate User command to open a TL1 session:

**ACT-USER:[<TID>]:<UID>:<CTAG>:::<PID>;**



**Note** When the semicolon is typed, the TL1 command is executed immediately.

- Step 6** Type the Cancel User command to close a TL1 session:

**CANC-USER:[<TID>]:<USERID>:<CTAG>;**

## 2.2 Test Access



**Note** Test access applies to the ONS 15454, ONS 15310-MA, and ONS 15600. Test access does not apply to the ONS 15310-CL.



**Note** Refer to the *Cisco ONS SONET TL1 Command Guide* for complete command and autonomous message information.

The test access (TACC) feature allows a third-party Broadband Remote Test Unit (BRTU) to create nonintrusive test access points (TAPs) to monitor the circuits on the ONS 15454, ONS 15310-MA, and ONS 15600 for errors. The test access feature also allows the circuit to be split (intrusive), so that the transmission paths can be tested for bit errors through the use of various bit patterns. The two BRTUs supported by the ONS 15454, ONS 15310-MA, and ONS 15600 are the Hekimian/Spirent BRTU-93 (6750) and the TTC/Acterna Centest 650.

The test access functionality provides TL1 commands for creating and deleting TAPs, connecting or disconnecting TAPs to circuit cross-connects, and changing the mode of test access on the ONS 15454, ONS 15310-MA, and ONS 15600. To view test access information in CTC, in node view click the **Maintenance > Test Access** tabs.

Refer to Telcordia document GR-834-CORE, *Network Maintenance: Access and Testing* and GR-1402-CORE, *Network Maintenance: Access Testing - DS3 HCDS TSC/RTU and DTAU Functional Requirements* for more information about test access.

A TAP provides the capability of connecting the circuit under test to a BRTU. This connection initially provides in-service monitoring capability to permit the tester to determine that the circuit under test is idle. The monitor connection should not disturb the circuit under test. The access point and remote test unit (RTU) also provide the capability of splitting a circuit under test. A split consists of breaking the transmission path of the circuit under test. This is done out of service. The two sides of the access point are called the Equipment (E) and Facility (F) directions. For a 4-wire or 6-wire circuit, the transmission pairs within the access point are defined as the A and B pairs. The circuit under test should be wired into the access point so that the direction of transmission on the A pair is from E to F, and the transmission direction for the B pair is from F to E (Figure 2-1).

Figure 2-1 Circuit With No Access Dual FAD TAP

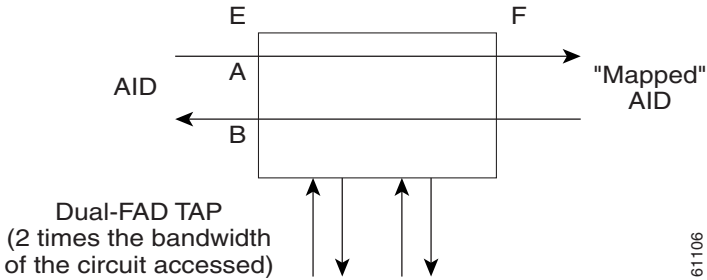

A dual facility access digroup (FAD) TAP uses twice the bandwidth of the circuit under test. This can be specified by the TAPTYPE parameter as shown in the ED-<MOD2> command syntax in the “2.2.2 TAP Creation and Deletion” section on page 2-7. The values are SINGLE and DUAL. It defaults to DUAL.

A single FAD TAP uses half the bandwidth as that of the dual FAD, that is, it uses the same bandwidth as the circuit accessed for the TAP creation. This can be specified by the TAPTYPE parameter as shown in the “2.2.2 TAP Creation and Deletion” section on page 2-7. The values are SINGLE and DUAL. The MONEF, SPLTAB, and SPLTEF modes are not supported by single FAD TAPs (Figure 2-2).

Figure 2-2 Circuit With No Access Single FAD TAP

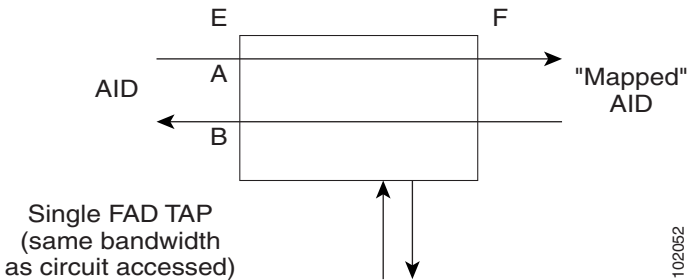

## 2.2.1 Test Access Terminology

The terminology in [Table 2-2](#) is used in conjunction with test access.

**Table 2-2** Test Access Terminology

Term	Definition
BRTU	Broadband remote test unit
DFAD	Dual facility access digroup
FAD	Facility access digroup
FAP	Facility access path
LOOPE	Split/loop access on A and B paths equipment side
LOOPF	Split/loop access on A and B paths facility side
MONE	Monitor access with signal detector on A path
MONF	Monitor access with signal detector on B path
MONEF	Monitor access with signal detector on A and B paths
QRS	Quasi-random signal (bit test pattern)
SPLTA	Split access on A path with signal detector from equipment, QRS on facility side
SPLTB	Split access on B path with signal detector from equipment, QRS on equipment side
SPLTE	Split access on A and B paths with signal detector from equipment, QRS on equipment side
SPLTF	Split access on A and B paths with signal detector from equipment, QRS on facility side
SPLTEF	Split access on A and B paths for testing in both equipment and facility directions
TACC	Test access
TAP	Test access path/point

The following path naming conventions apply to test access:

- E—Equipment test access point direction
- F—Facility test access point direction
- A—Transmission path (the direction of transmission on the A pair is from E to F)
- B—Transmission path (the transmission direction for the B pair is from F to E)

## 2.2.2 TAP Creation and Deletion

TL1 supports commands to create, delete, connect, change, retrieve, and disconnect TAPs.

### 2.2.2.1 ED-<rr>

The edit command (ED-<rr>) is used to change an existing port, synchronous transport signal (STS), or Virtual Tributary (VT) to a TAP.

**Note**

<rr> indicates one of the following parameters: **T1, T3, STS1, STS3c, STS6c, STS9c, STS12c, STS24c, STS48c, STS192c, VT1, DS1**.

Input Format:

**ED-(T1, T3, STS1, STS3c, STS6c, STS9c, STS12c, STS24c, STS48c, STS192c, VT1, DS1):[<TID>]:<AID>:<CTAG>[::TACC=<TACC>][TAPTYPE=<TAPTYPE>];**

Edit an existing port, STS, or VT and change it to a TAP so it can be used when requesting TACC connections. Includes a new optical parameter, TACC=n, that defines the port, STS, or VT as a TAP with a selected unique TAP number. This TAP number will be used when requesting test access connections to circuit cross-connections under test. The TAP creation will fail if there is a cross-connection already on the port, STS, or VT.

**Note**

- This command generates a REPT DBCHG message.
- The alarms and conditions on test access paths can be retrieved by the RTRV-ALM-ALL or RTRV-ALM-<MOD2> commands.
- The TAP is a persistent object. It will exist after the user has logged out of the TL1 session.

The following list applies to TAP numbers:

- The TAP number is an integer within the range of 1 to 999. When TACC=0 is specified, the TAP is deleted (if already present).
- The TAP number is unique across T1/T3/STS/VT/DS1 TAPs in the system.
- The TAP number is not editable.

## 2.2.2.2 ED-T1

When the ED-T1 command is issued with a specified TACC value for a given T1 port/facility, a dual facility access group (DFAD) is created by using the specified port/facility and the consecutive port/facility.

The command in [Example 2-1](#) creates a DFAD on FAC-1-1 and FAC-1-2.

### **Example 2-1 Create a DFAD on FAC-1-1 and FAC-1-2**

```
ED-T1::FAC-1-1:12::TACC=1;

      DV9-99 1970-01-02 03:16:11
M 12 COMPLD
;
```

**Note**

These ports/facilities cannot be used for the creation of cross-connects until the TAP is deleted.

## 2.2.2.3 ED-T3

When the ED-T3 command is issued with a specified TACC value for a given T3 port/facility, a DFAD is created by using the specified port/facility and the consecutive port/facility.

The command in [Example 2-2](#) creates a T3 DFAD on FAC-2-1 and FAC-2-2.

**Example 2-2 Create a T3 DFAD on FAC-2-1 and FAC-2-2**

```
ED-T3::FAC-2-1:12::TACC=2;

    DV9-99 1970-01-02 03:16:11
M 12 COMPLD
;
```

**Note**

---

These ports/facilities cannot be used for the creation of cross-connects until the TAP is deleted.

---

**2.2.2.4 ED-DS1**

When the ED-DS1 command is issued with a specified TACC value for a given DS1 facility on a DS3XM card, a DFAD is created by using the specified facility and the consecutive port/facility.

The command in [Example 2-3](#) creates DFAD on DS1-2-1-1 and DS1-2-1-2.

**Example 2-3 Create a DFAD on DS1-2-1-1 and DS1-2-1-2**

```
ED-DS1::DS1-2-1-1:12::TACC=3;

    DV9-99 1970-01-02 03:16:11
M 12 COMPLD
;
```

**Note**

---

These ports/facilities cannot be used for the creation of cross-connects until the TAP is deleted.

---

**2.2.2.5 ED-STSn**

When the ED-STSn command is issued for a TACC, it assigns the STS for the first two-way test access connection and STS+1 as the second two-way connection. For STS3c, STS9c, STS12c, STS24c, and STS48c, the next consecutive STS of same width is chosen. The TAP creation will fail if either of the consecutive STSs are not available.

The command in [Example 2-4](#) creates a TAP on STS-5-1 and STS-5-2.

**Example 2-4 Create a TAP on STS-5-1 and STS-5-2**

```
ED-STS1::STS-5-1:12::TACCC=4

    DV9-99 1970-01-02 03:16:11
M 12 COMPLD
;
```

**Note**

---

These STSs cannot be used for the creation of cross-connects until the TAP is deleted.

---

The command in [Example 2-5](#) creates an STS24c dual TAP on STS-6-1 and STS-6-25.

**Example 2-5 Create an STS24c Dual TAP on STS-6-1 and STS-6-25**

```
ED-STS24C::STS-6-1:12::TACC=5:
    DV9-99 1970-01-02 03:16:11
M 12 COMPLD
;
```

**Note**

---

These STSs cannot be used for the creation of cross-connects until the TAP is deleted.

---

**2.2.2.6 ED-VT1**

When the ED-VT1 command is issued for a TACC, a VT TAP is created. The specified VT access identifier (AID) is taken as the first VT connection. The second VT connection is made by incrementing the VT group and keeping the VT number the same.

The command in [Example 2-6](#) creates a VT TAP on VT1-1-1-1-1 and VT1-1-1-2-1.

**Example 2-6 Create a VT TAP on VT1-1-1-1-1 and VT1-1-1-2-1**

```
ED-VT1-1-1-1-1:12::TACC=6;
    DV9-99 1970-01-02 03:16:11
M 12 COMPLD
;
```

**Note**

---

These VTs cannot be used for the creation of cross-connects until the TAP is deleted.

---

**2.2.3 Connect Test Access Points**

The connect test access points command (CONN-TACC-<rr>) is used to make a connection between the TAP and the circuit or cross-connect under test.

**Note**

---

<rr> indicates one of the following parameters: **T1, T3, STS1, STS3c, STS6c, STS9c, STS12c, STS24c, STS48c, STS192c, VT1, DS1**.

---

Input Format:

```
CONN-TACC-(T1, T3, STS1, STS3C, STS6C, STS9C, STS12C, STS24C, STS48C, STS192c,
VT1,DS1):[<TID>]:<AID>:<CTAG>::<TAP>:MD=<MD>;
```

Connect the port, STS, or VT defined by <AID> to the port, STS, or VT defined by the <TAP> number. The mode of test access to the circuit or cross-connect is specified by <MD>. The mode can be either monitor (nonintrusive), split (intrusive), or loop (intrusive) mode. The various modes are described in the [“2.2.9 Test Access Mode Definitions”](#) section on page 2-16.

**Note**

---

The connection is maintained only for the duration of the TL1 session (nonpersistent).

---

**Note**

---

The TAP number is displayed at the output if the CONN-TACC command completes successfully.

---

The following error codes are supported:

- RTBY—Requested TAP busy
- RTEN—Requested TAP does not exist
- SCAT—Circuit is already connected to another TAP
- SRCN—Requested condition already exists
- IIAC—Invalid access identifier (AID)
- EANS—Access not supported
- SRAC—Requested access configuration is invalid

The command in [Example 2-7](#) creates a connection between TAP number one and the port/facility FAC-1-3 with the access mode defined as MONE. The various modes are described in the “[2.2.9 Test Access Mode Definitions](#)” section on page 2-16.

**Example 2-7 Create a Connection Between TAP 1 and FAC-1-3**

```
CONN-TACC-T1::FAC-1-3:12::1:MD=MONE;

    DV9-99 1970-01-02 02:51:54
M 12 COMPLD
  1
;
```

## 2.2.4 Change Access Mode

The change access mode command (CHG-ACCMD-<rr>) is used to change the access mode.



**Note**

<rr> indicates one of the following parameters: T1, T3, STS1, STS3c, STS6c, STS9c, STS12c, STS24c, STS48c, STS192c, VT1, DS1.

Input Format:

**CHG-ACCMD-(T1, T3, STS1, STS3C, STS6C, STS9C, STS12C, STS24C, STS48C, STS192c, VT1, DS1):[<TID>]:<TAP>:<CTAG>::<MD>;**

Use this command to change the type of test access. This might be a change from monitoring the data to inserting data into the STS. This command can only be applied to an existing TAP connection. If a TAP connection does not exist, a RTEN error is returned.

The following error codes are supported:

- SRCN—Requested condition already exists
- SRAC—Requested access configuration is invalid
- RTEN—Requested TAP does not exist

The command in [Example 2-8](#) changes the access mode of TAP 1 to LOOPE.

**Example 2-8 Change TAP 1 Access Mode to LOOPE**

```
CHG-ACCMD-T1::1:12::LOOPE;

      DV9-9 1970-01-02 02:59:43
M 12 COMPLD
;
```



---

**Note** The access mode cannot be changed if the TAP is not connected.

---



---

**Note** This command generates a REPT DBCHG message.

---

## 2.2.5 Retrieve Test Access Point Information

The following sections retrieve TAP information using the RTRV-<rr> and RTRV-TACC commands. Refer to the *Cisco ONS SONET TL1 Command Guide* for specific command formats and examples.

### 2.2.5.1 RTRV-<rr>

The RTRV-<rr> command retrieves TAP information.



---

**Note** A generic ALL AID would behave similarly to an ALL AID such as SLOT-ALL or FAC-1-ALL for all the RTRV-<rr> commands that support a generic ALL AID.

---



---

**Note** <rr> indicates one of the following parameters: T1, T3, STS1, STS3c, STS6c, STS9c, STS12c, STS24c, STS48c, STS192c, VT1, DS1.

---

Input Format:

```
RTRV-(T1, T3, STS1, STS3C, STS6C, STS9C, STS12C, STS24C, STS48C, STS192c, VT1,
DS1):[<TID>]:<AID>:<CTAG>;
```

This command is modified to include the return of a TAP number if the requested <AID> is defined as a TAP. An optional TACC=<TAPNUMBER> will appear in the output list if the requested <AID> is defined as a TAP. The example in [Example 2-9](#) retrieves TAP information for FAC-1-1.

**Example 2-9 Retrieve TAP Information for FAC-1-1**

```
RTRV-T1::FAC-1-1:12;

      dv9-99 1970-01-02 02:49:16
M 12 COMPLD
  "FAC-1-1::LINECDE=AMI, FMT=D4, LBO=0-131, TACC=1, TAATYPE=DUAL:OOS"
;
```

## 2.2.5.2 RTRV-TACC

The RTRV-TACC command can also be used to retrieve details associated with a TAP.

Input Format:

```
RTRV-TACC:[<TID>]:<TAP>:<CTAG>;
```

The TAP is identified by the TAP number. The ALL input TAP value means that the command will return all the configured TACCs in the NE. An example of the RTRV-TACC command is provided in [Example 2-10](#).

### *Example 2-10 Retrieve Details for TAP 241*

```
RTRV-TACC:CISCO:241:CTAG;

      TID-000 1998-06-20 14:30:00
M 001 COMPLD
"241:STS-2-1-1.STS-2-2,MONE,STS-12-1-1,STS-13-1-1"
;
```

## 2.2.6 Disconnect Test Access Points

TAPs can be disconnected in the following ways:

- Issue the DISC-TACC command.
- Delete or modify the accessed connection.
- Drop the TL1 session for any reason, including logout or a dropped Telnet session.
- Switch or reset a TCC2/TCC2P or XTC card.

The disconnect TAP (DISC-TACC) command disconnects the TAP and puts the connection back to its original state (no access).

Input Format:

```
DISC-TACC:[<TID>]:<TAP>:<CTAG>;
```

The command in [Example 2-11](#) disconnects TAP 1 from the circuit/cross-connect under test.

### *Example 2-11 Disconnect TAP 1 from the Circuit/Cross-Connect Under Test*

```
DISC-TACC::1:12;

      DV9-99 1970-01-02 02:59:43
M 12 COMPLD
;
```



#### Note

This command generates a REPT DBCHG message.

The following error codes are supported:

- SADC—Already disconnected
- SRTN—Unable to release TAP

## 2.2.7 Delete Test Access Points

To delete a TAP, issue the edit TAP command with the TACC set to zero.

Input Format:

```
ED-<STS_PATH>:[<[TID]>]:<AID>:<CTAG>:::TACC=0;
```



**Note**

The TACC number must be set to zero in order to delete a TAP.



**Note**

If a TAP is not removed, the STS bandwidth will be stranded.

## 2.2.8 Test Access Configurations

This section shows single node ([Figure 2-3](#)) and multinode ([Figure 2-4](#)) test access configurations.

Use the following commands to configure test access:

**Step 1** `ED-STs1::STs-1-1-1:90:::TACC=1;`

This command changes STS1 and STS2 on Slot 1 to a TAP. The CTAG is 90. It sets the TACC number to 1.

**Step 2** `CONN-TACC-STs1::<AID for E or F depending on MD>;91::1:MONE`

This command connects the <AID> to the TACC defined by TAP 1 on the E side. The CTAG is 91.



**Note**

The connection made in the CONN-TACC command can use MONE to connect to the F side AID. The AID provided designates the E side and the other automatically becomes the F side. For example, if an <AID F> is supplied to a MONE connection, then the top line would be connected to the other side of the path, or what is shown in [Figure 2-3](#) as the F side. When a CONN-TACC is set up, these designations cannot change until a DISC-TACC or another CONN-TACC command is executed. The connection is based on the AID supplied.

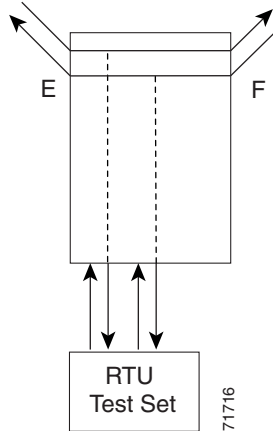
**Figure 2-3** Single Node View (Node 1)

In the [Figure 2-3](#) configuration, there might be a single DS-3 port wired up, configured as 14 dual FADs (28 VTs).

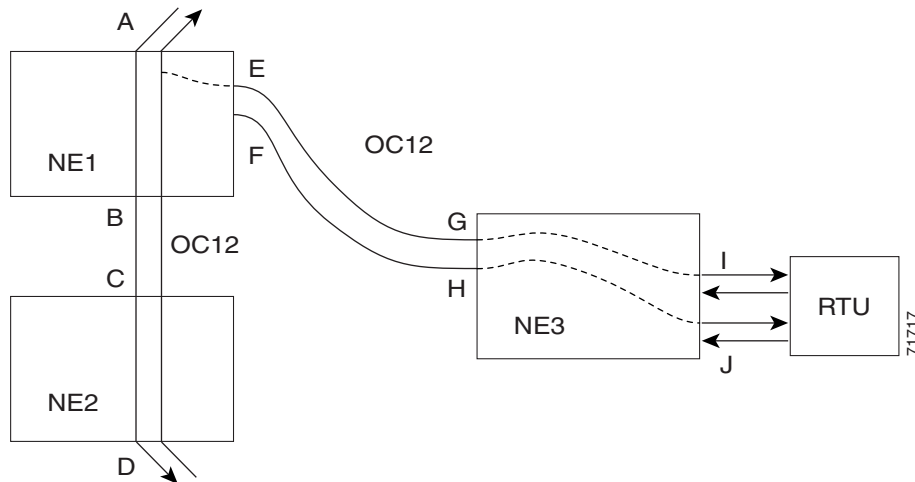
**Figure 2-4** Multinode View (MONE Example)

The following commands are performed on NE3:

```
ENT-CRS-STS1::<AID I-G>:100::2WAY;
```

A connection, not a TAP. CTAG is 100.

```
ENT-CRS-STS1::<AID J-H>:101::2WAY;
```

Second connection, not a TAP.

The following commands are performed on NE1:

Assuming the path from A to B is already entered, the A and B points in [Figure 2-4](#) refer to entry and exit points on the node or different cards. The E/F designators refer to the two two-way connections from NE3.

The following command creates a TAP with STS-1-1 and STS-1-2 through NE1. TAP number assigned is 4.

```
ED-STST1::STS-1-1:TACC=4;
```

The following command connects TAP 4 to the circuit:

```
CONN-TACC-STTS1::<AID A or B>:102::4:<MD>
```



**Note**

The I and J connections above are TAPs in [Figure 2-3](#), but normal connections in the [Figure 2-4](#).

## 2.2.9 Test Access Mode Definitions

The following diagrams show what the different test access modes (<MD>) refer to. [Figure 2-5](#) shows a circuit with no access (dual FAD TAP) and [Figure 2-6](#) shows a circuit with no access (single FAD TAP). The subsections that follow show the circuits in each test access mode. The QRS can be generated by an outside source, for example, the empty connection of the BRTU.

The subsections that follow describe the modes:

MONE, MONF, and MONEF access modes are Non-Service Affecting and can be applied to an In Service (IS) port state.

LOOPE, LOOPF, SPLTE, SPLTF, SPLTEF, SPLTA, SPLTB, and SPLTAB access modes are intrusive and can be applied only to a circuit or /port that is in the Out Of Service, Maintenance (OOS\_MT) port state. The NE will change the state of the circuit under test to OOS\_MT during the period of TACC and restore it to the original state when the connection between the TAP and the circuit is dropped.

**Figure 2-5** *Circuit With No Access (Dual FAD TAP)*

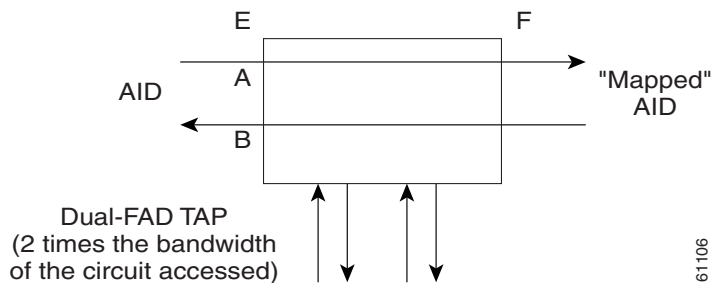

**Figure 2-6** *Circuit With No Access (Single FAD TAP)*

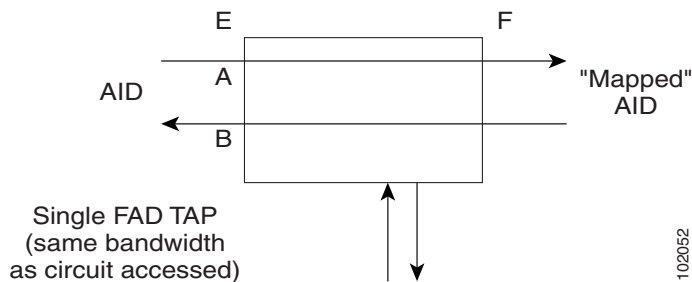

### 2.2.9.1 MONE

Monitor E (MONE) mode indicates a monitor connection provided from the FAD to the A transmission path of the accessed circuit (Figure 2-7 and Figure 2-8). This is a nonintrusive mode.

**Figure 2-7 MONE Access Mode Single TAP**

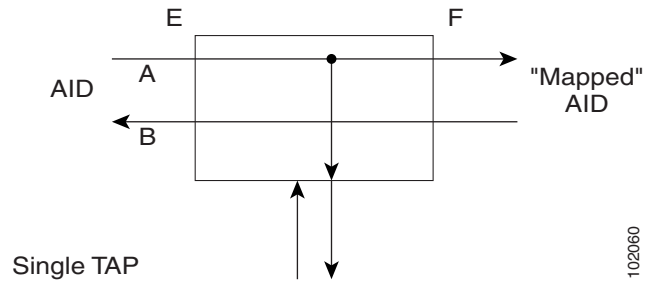

102060

**Figure 2-8 MONE Access Mode Dual TAP**

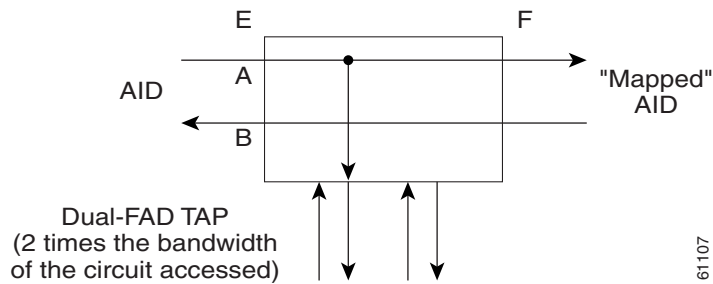

61107

### 2.2.9.2 MONF

Monitor F (MONF) mode indicates that the FAD is providing a monitor connection to the B transmission path of the accessed circuit (Figure 2-9 and Figure 2-10). This is a nonintrusive mode.

**Figure 2-9 MONF Access Mode Single TAP**

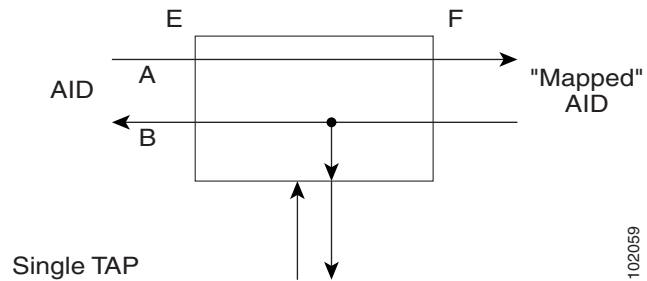

102059

Figure 2-10 MONF Access Mode Dual TAP

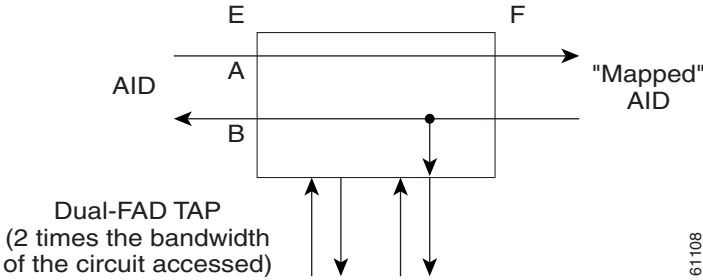

**Note**

The MONE and SPLTA modes are applicable to unidirectional circuits from E to F. The MONF and SPLTB modes are applicable to unidirectional circuits from F to E.

2.2.9.3 MONEF

Monitor EF (MONEF) mode is a monitor connection provided from the FAD1 (odd pair) to a DFAD, to the A transmission path, and from FAD2 (even pair) of the same DFAD, to the B transmission path of the accessed circuit. This is a nonintrusive mode (Figure 2-11).

MONEF mode for T3 (DS3 high capacity digital service [HCDS]) indicates that the odd pair of an FAP is providing a monitor connection to the A transmission path and from the even pair of an FAP to the B transmission path of the accessed circuit.

Figure 2-11 MONEF Access Mode Dual TAP

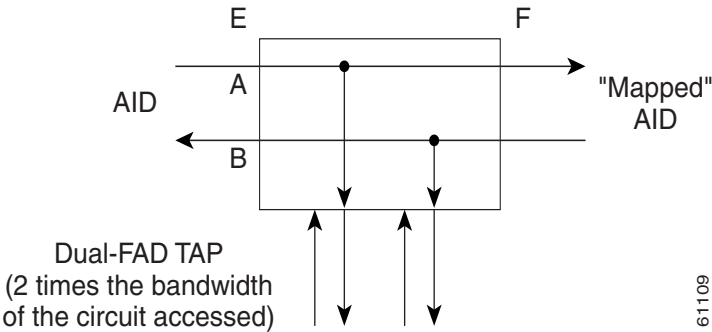

2.2.9.4 SPLTE

Split E (SPLTE) mode splits both the A and B paths and connects the E side of the accessed circuit to the FAD (Figure 2-12 and Figure 2-13).

**Note**

QRS is not supported on the ONS 15454 and ONS 15310-CL. The connection will remain as is. The ONS 15600 inserts alarm indication signal (AIS) instead of QRS.

**Figure 2-12** *SPLTE Access Mode Single TAP*

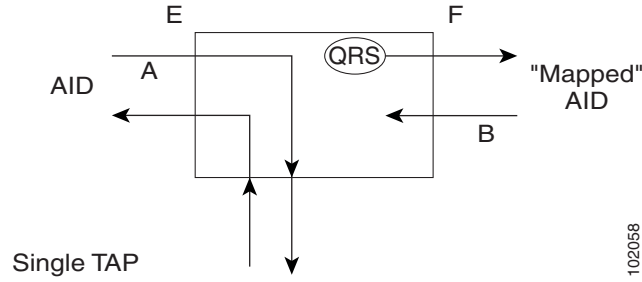

**Figure 2-13** *SPLTE Access Mode Dual TAP*

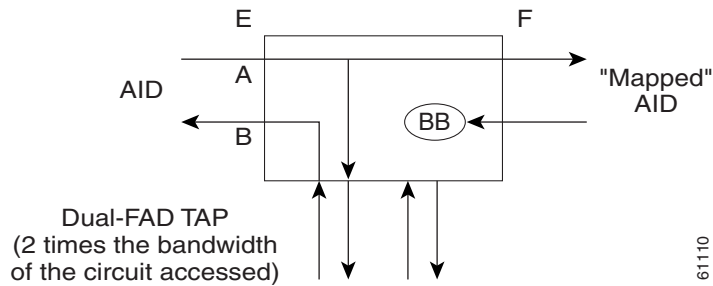

### 2.2.9.5 SPLTF

Split F (SPLTF) mode splits both the A and B paths and connects the F side of the accessed circuit to the FAD (Figure 2-14 and Figure 2-15).



**Note**

QRS is not supported on the ONS 15454 and ONS 15310-CL. The connection will remain as is. The ONS 15600 inserts AIS instead of QRS.

**Figure 2-14** *SPLTF Access Mode Single TAP*

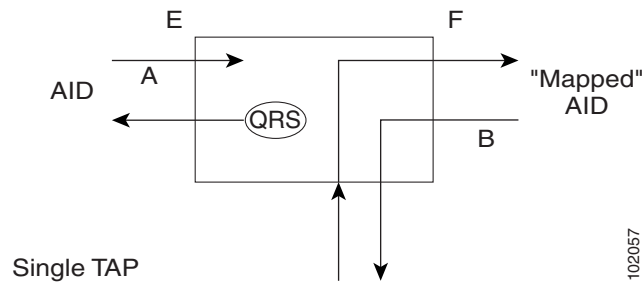
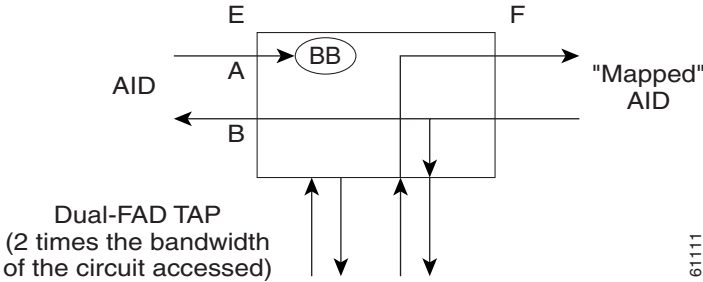

Figure 2-15 SPLTF Access Mode Dual TAP



61111

2.2.9.6 SPLTEF

Split EF (SPLTEF) mode for T1 (DS1 HCDS) splits both the A and B paths, connects the E side of the accessed circuit to FAD1 and the DFAD pair, and connects the F side to the FAD2 of the same DFAD pair (Figure 2-16).

SPLTEF mode for T3 (DS3 HCDS) splits both the A and B paths and connects the E side of the accessed circuit to the odd pair of the FAP and the F side to the even pair of the FAP.

Figure 2-16 SPLTEF Access Mode Dual TAP

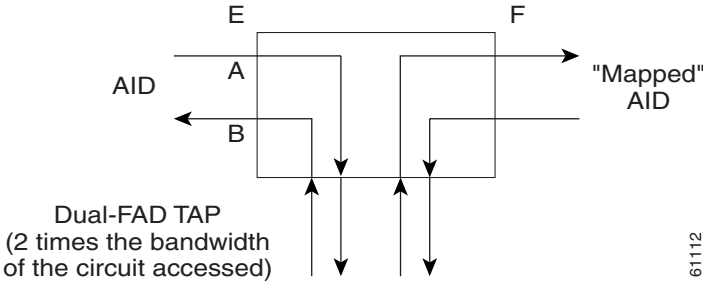

61112

2.2.9.7 LOOPE

Loop E (LOOPE) mode splits both the A and B paths, connects the incoming line from the E direction to the outgoing line in the E direction, and connects this looped configuration to the FAD (Figure 2-17 and Figure 2-18). Loop E and F modes are basically identical to the SPLT E and F modes except that the outgoing signal is the incoming signal and not the signal from the remote test unit (RTU).



Note

QRS is not supported on the ONS 15454 and ONS 15310-CL. The connection will remain as is. The ONS 15600 inserts AIS instead of QRS.

**Figure 2-17 LOOPE Access Mode Single TAP**

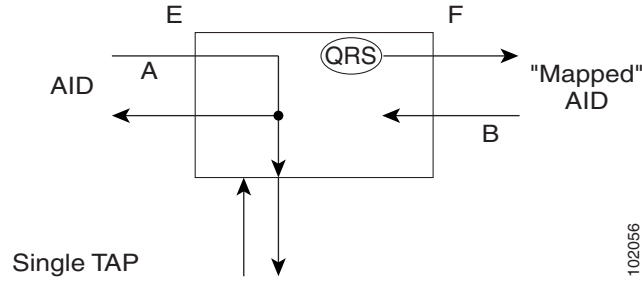

102056

**Figure 2-18 LOOPE Access Mode Dual TAP**

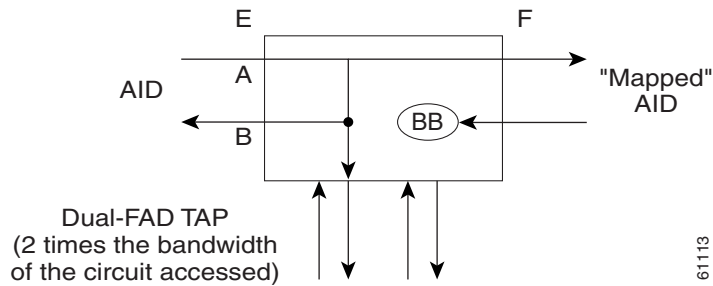

61113

### 2.2.9.8 LOOPF

Loop F (LOOPF) mode splits both the A and B paths, connects the incoming line from the F direction to the outgoing line in the F direction and connects this looped configuration to the FAD (Figure 2-19 and Figure 2-20).



**Note**

QRS is not supported on the ONS 15454 and ONS 15310-CL. The connection will remain as is. The ONS 15600 inserts AIS instead of QRS.

**Figure 2-19 LOOPF Access Mode Single TAP**

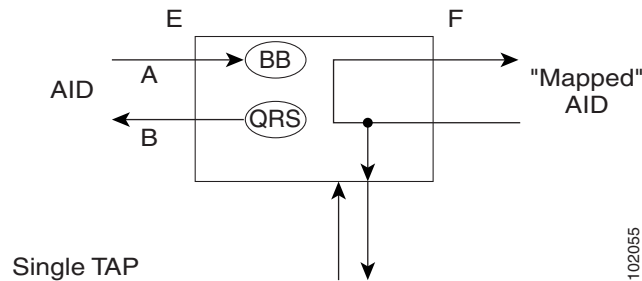

102055

Figure 2-20 LOOPF Access Mode Dual TAP

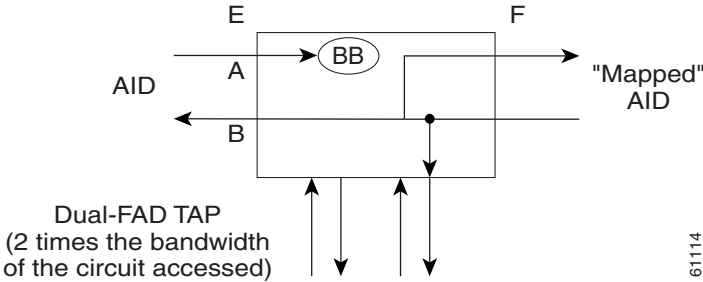

### 2.2.9.9 SPLTA

Split A (SPLTA) mode indicates that a connection is provided from both the E and F sides of the A transmission path of the circuit under test to the FAD and splits the A transmission path (Figure 2-21 and Figure 2-22). This mode is similar to the SPLTE and SPLTF modes, except the signals are sent to the RTU, not the NE signal configuration.

Figure 2-21 SPLTA Access Mode Single TAP

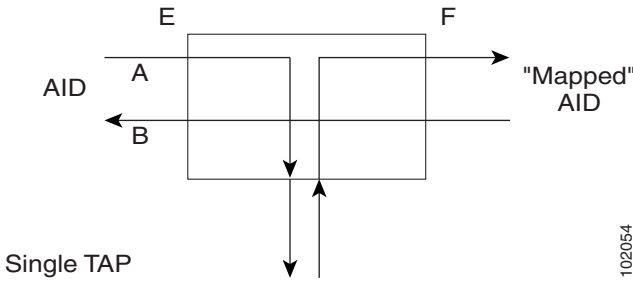
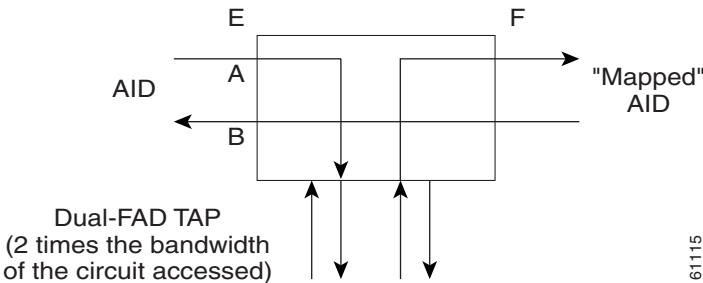
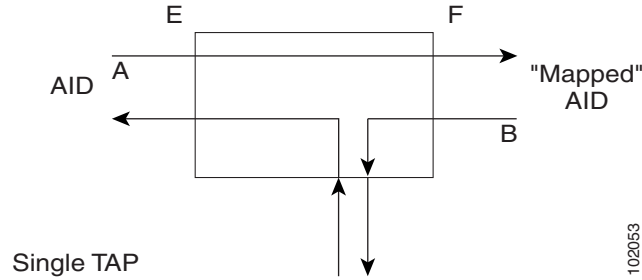
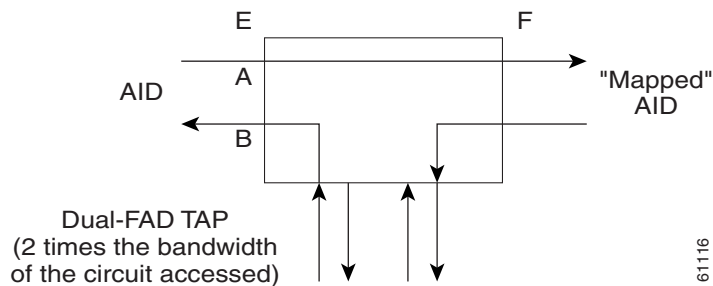

Figure 2-22 SPLTA Access Mode Dual TAP



### 2.2.9.10 SPLTB

Split B (SPLTB) mode indicates that a connection is provided from both the E and F sides of the B transmission path of the circuit under test to the FAD and splits the B transmission path (Figure 2-23 and Figure 2-24).

**Figure 2-23** *SPLTB Access Mode Single TAP***Figure 2-24** *SPLTB Access Mode Dual TAP*

## 2.2.10 Unmapped AID Test Access Point Connections

The ONS 15454 and ONS 15600 support connections to unmapped AIDs (unmapped circuits). The TAPs can be connected to an unmapped AID, for example, an AID that does not have a cross-connect on it. The access modes supported are: MONE, SPLTE, and LOOPE.

[Example 2-12](#) creates a TAP on STS-5-1 and STS-5-2.

### **Example 2-12** *Create a TAP on STS-5-1 and STS-5-2*

```
ED-ST1::STS-5-1:12::TACC=1;

    DV9-99 1970-01-02 03:16:11
M 12 COMPLD
;
```

[Example 2-13](#) creates an unmapped AID connection with the MONE access mode.

### **Example 2-13** *Create an Unmapped AID Connection with the MONE Access Mode*

```
CONN-TACC-ST1::STS-5-3:12::1:MD=MONE;

    DV9-99 1970-01-02 02:51:54
M 12 COMPLD
  1
;
```

**Note**

---

STS-5-3 does not have a cross-connect on it. STS-5-3 becomes unusable until the connection is disconnected by the DISC-TACC command.

---

**Note**

---

The <AID> provided in the CONN-TACC command designates the E side and the other automatically becomes the F side.

---

**Note**

---

In the case of all one-way circuits (1-way, UPSR\_HEAD, UPSR\_DROP, UPSR\_DC, UPSR\_EN), if the <AID> specified is the source AID, the direction is designated as From E in [Table 2-3 on page 2-25](#). If the <AID> specified is the destination AID or the drop side, the direction is designated as From F in [Table 2-3 on page 2-25](#).

---

### 2.2.10.1 One-Way Circuit

The examples in this section assume that an STS TAP is already created with a TAP number of 1.

```
ENT-CRS-STST1::STS-5-1,STS-5-2:12::1WAY;
DV9-99 1970-07-01 20:29:06
M 12 COMPLD;

CONN-TACC-STST1::STS-5-1:12::1:MD=MONF;
DV9-99 1970-01-01 20:29:47
M 12 DENY
EANS
STS-5-1
/*INCORRECT TAP MODE*/
```

The <AID> specified in the above CONN-TACC command is the source AID for the one-way circuit. In this case, only MONE and SPLTA modes are allowed because there is no B path in the case of a one-way circuit (see [Table 2-3 on page 2-25](#)).

```
CONN-TACC-STST1::STS-5-1:12::1:MD=MONE;
DV9-99 1970-01-01 20:30:09
M 12 COMPLD

DISC-TACC::1:12;
DV9-99 1970-01-01 20:30:20
M 12 COMPLD
;
```

However, if the AID specified is the destination AID, as shown below, the modes allowed are MONF and SPLTB.

```
CONN-TACC-STST1::STS-5-2:12::1:MD=MONF;
DV9-99 1970-01-01 20:30:32
M 12 COMPLD
```

**Note**

- 
- The same examples apply for UPSR\_HEAD, UPSR\_DROP, UPSR\_DC and UPSR\_EN, which are all one-way circuits.
  - The connections are made only to the working path, irrespective of which path is currently active.
-

## 2.2.10.2 Two-Way Circuits

For two-way circuits, all the modes are allowed, as shown in [Table 2-3](#). The same applies for UPSR\_UPSR and path protection circuit types. In the case of UPSR\_UPSR and path protection circuits, the working path is connected irrespective of which path is currently active.

## 2.2.10.3 Unmapped AID

As explained in the “[2.2.10 Unmapped AID Test Access Point Connections](#)” section on page 2-23, connections can be made to an AID without a cross-connect on it. The modes supported are MONE, SPLTE, and LOOPE, as shown in [Table 2-3](#).

**Note**

The AID provided in the CONN-TACC command designates the E side and the other automatically becomes the F side.

**Table 2-3** Modes Supported by Circuit Type

	MONE	MONF	MONEF	SPLTE	SPLTF	SPLTEF	LOOPE	LOOPF	SPLTA	SPLTB
1-way (from E) <sup>1</sup>	X	—	—	—	—	—	—	—	X	—
1-way (from F) <sup>2</sup>	—	X	—	—	—	—	—	—	—	X
2-way	X	X	X	X	X	X	X	X	X	X
Path Protection	X	X	X	X	X	X	X	X	X	X
UPSR_HEAD (from E)	X	—	—	—	—	—	—	—	X	—
UPSR_HEAD (from F)	—	X	—	—	—	—	—	—	—	X
UPSR_DROP UPSR_DC UPSR_EN (from E)	X	—	—	—	—	—	—	—	X	—
UPSR_DROP _DC UPSR_EN (from F)	—	X	—	—	—	—	—	—	—	X
UPSR_UPSR	X	X	X	X	X	X	X	X	X	X
Unmapped AID	X	—	—	X	—	—	X	—	—	—

1. If the AID specified is the source AID, the direction is designated as “from E” in all one-way circuits (1-way, UPSR\_HEAD, UPSR\_DROP, UPSR\_DC, and UPSR\_EN).
2. If the AID specified is the destination AID or the drop side, the direction is designated as “from F” in all one-way circuits (1-way, UPSR\_HEAD, UPSR\_DROP, UPSR\_DC, and UPSR\_EN).

# 2.3 TL1 Gateway

This section describes the TL1 gateway and provides procedures and examples for implementing TL1 gateway on the ONS 15454, ONS 15310-CL, ONS 15310-MA, and ONS 15600.

## 2.3.1 Gateway Network Element Topology

You can issue TL1 commands to multiple nodes through a single connection using the TL1 gateway. Any node can serve as a Gateway Network Element (GNE), End Network Element (ENE), or Intermediate Network Element (INE). A node becomes a GNE when a TL1 user connects to it and enters a command destined for another node. An ENE is an end node because it processes a TL1 command that is passed to it from another node. An INE is an intermediate node because of topology; it has no special hardware, software, or provisioning.

To implement the TL1 gateway, use the desired ENE's TID in the ACT-USER command to initiate a session between the GNE and the ENE. After a session is established, you need to enter the ENE's TID in all of the subsequent commands that are destined for the ENE. From the GNE, you can access several remote nodes, which become the ENEs. The ENEs are the message destinations or origins. The INE handles the data communications channel (DCC) TCP/IP packet exchange.

The GNE Session is the connection that multiplexes TL1 messages between the operations support system (OSS)/craftsperson and the GNE. The GNE demultiplexes incoming OSS TL1 commands and forwards them to the remote ENE. The GNE also multiplexes incoming responses and autonomous messages to the GNE Session. The ENE Session is the connection that exchanges messages between the GNE and the remote ENE. Figure 2-25 shows the GNE topology.

Figure 2-25 Example of a GNE Topology

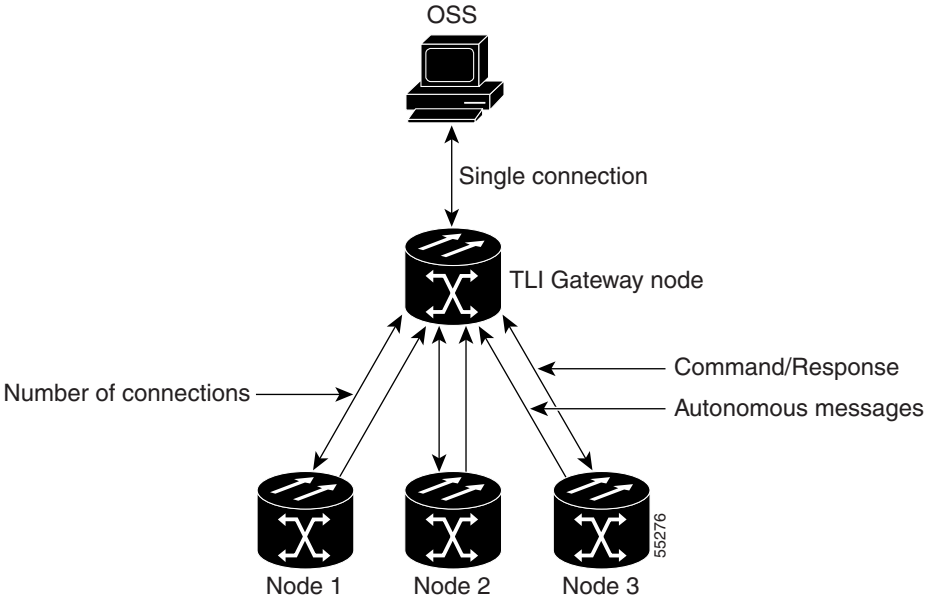

## 2.3.2 TL1 Sessions

Each NE can support up to a maximum of 20 concurrent communication sessions (connections from an OS/NE to the GNE). The TL1 connections can be made through telnet sessions from the LAN or from the craft/serial port connection on the NE. One TL1 session is reserved for the active serial port connection. The remaining 19 sessions are used for TL1 sessions through the LAN (wire-wrap, active serial port, or DCC). [Table 2-4](#) shows the number of serial port and LAN connections per platform.

**Table 2-4** Number of TL1 Sessions per Platform

Platform	Number of Serial Port Sessions	Number of LAN Sessions	Total Number of TL1 Sessions
Cisco ONS 15454	1	19	20
Cisco ONS 15310-CL	1	19	20
Cisco ONS 15310-MA	2	18	20
Cisco ONS 15600	2	18	20

## 2.3.3 TL1 Gateway and ENE Sessions

Only a limited number of TL1 users logged into an NE at any given time can establish sessions to other ENEs. The active serial port sessions are reserved and can always become a GNE session. The number of ENE sessions is based on the number of gateway communication sessions (GNE sessions).

Each NE can support up to 12 concurrent communication gateway sessions, depending on the NE type. The maximum number of ENE sessions also varies depending on the NE type.

You can dynamically distribute the maximum number of ENE sessions to balance the number of concurrent gateway communication sessions. The GNE treats the concurrent gateway communication sessions and ENE/GNE limit as a resource pool. It continues to allocate resources until the pool is exhausted. When the pool is exhausted, the GNE returns an “All Gateways in Use” message or an “All ENE Connections in Use” message.



**Note**

The speed of the TL1 gateway and the maximum number of connections are limited by shared system resources, such as CTC, CTM, etc. The response time is slow as connections are increased and activity on these connections increases. Alarm storms, additional users, network latency, etc. also increase response time.

Cisco ONS 15600 allows up to 500 ENEs per GNE session from Software Release 6.0 and higher.

The gateway resource pools for each platform are shown in [Table 2-5](#).

**Table 2-5** Gateway Resource Pool

Platform	Maximum Number of GNE Sessions	Maximum Number of ENEs over IP DCC	Maximum Number of ENEs over OSI DCC
Cisco ONS 15454	11 (10 + 1)	176	20
Cisco ONS 15310-CL	6 (5 + 1)	92	20
Cisco ONS 15310-MA	7 (5 + 2)	112	20
Cisco ONS 15600	12 (10 + 2)	192 (500)	20

**Note**

Every ENE over an OSI DCC is equivalent to two ENEs over an IP DCC. If you use a combination of IP and OSI ENE sessions, it is important to remember that the maximum number of ENEs supported is equal to the number if IP ENEs plus two times the number of OSI ENEs ( $IP + 2*OSI$ ).

For example, for Cisco ONS 15454 GNE, if you use 100 ENEs over IP DCC, then you can use only 38 ENEs over OSI DCC ( $100 + 2*38 = 176$ ). For Cisco ONS 15310-MA GNE, if you use 30 ENEs over OSI DCC, then you can use only 52 ENEs over IP DCC ( $2*30+52 = 112$ ).

Examples of GNE/ENE resource allocation are provided in [Table 2-6](#).

**Table 2-6** *Examples of Ideal ENE to GNE Resource Allocations*

Applicable Cards	Number of GNE Communication Sessions	Number of ENEs over IP DCC	Number of ENEs over OSI DCC
15454 (TCC/TCC+/TCC2/TCC2P), 15310-CL (CTX), 15310-MA (CTX-2500), 15600 (TSC)	1	16	16
15454 (TCC/TCC+/TCC2/TCC2P), 15310-CL (CTX), 15310-MA (CTX-2500), 15600 (TSC)	2	32	20
15454 (TCC/TCC+/TCC2/TCC2P), 15310-CL (CTX), 15310-MA (CTX-2500), 15600 (TSC)	3	48	20
15454 (TCC/TCC+/TCC2/TCC2P), 15310-CL (CTX), 15310-MA (CTX-2500), 15600 (TSC)	4	64	20
15454 (TCC/TCC+/TCC2/TCC2P), 15310-CL (CTX), 15310-MA (CTX-2500), 15600 (TSC)	5	80	20
15454 (TCC/TCC+/TCC2/TCC2P), 15310-CL (CTX), 15310-MA (CTX-2500), 15600 (TSC)	6	96	20
15454 (TCC2/TCC2P), 15310-MA (CTX-2500), 15600 (TSC)	7	112	20
15454 (TCC2/TCC2P), 15600 (TSC)	8	128	20
15454 (TCC2/TCC2P), 15600 (TSC)	9	144	20
15454 (TCC2/TCC2P), 15600 (TSC)	10	160	20
15454 (TCC2/TCC2P), 15600 (TSC)	11	176	20
15600 (TSC)	12	192	20

## 2.3.4 Implementing TL1 Gateway

**Note**

Issuing commands to specific nodes in the network is accomplished by entering a unique node name in the TID field in each TL1 message. The TID field is synonymous with the name of the node and is the second token in a TL1 command.

The following procedures demonstrate TL1 gateway on a four-node ring (without TL1 gateway in [Figure 2-26](#) and with TL1 gateway in [Figure 2-27](#)), where:

- Node 0 is the GNE.
- Node 1 is the ENE 1.
- Node 2 is the INE 2.
- Node 3 is the ENE 3.

**Figure 2-26** *Four-Node Ring Without TL1 Gateway*

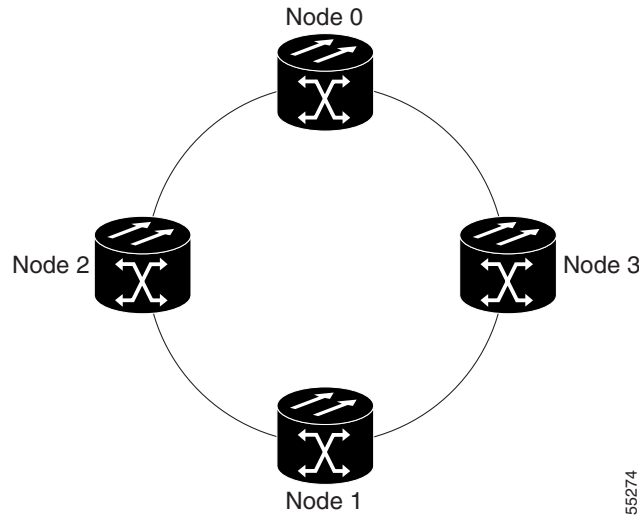

**Figure 2-27** *Four-Node Ring With TL1 Gateway*

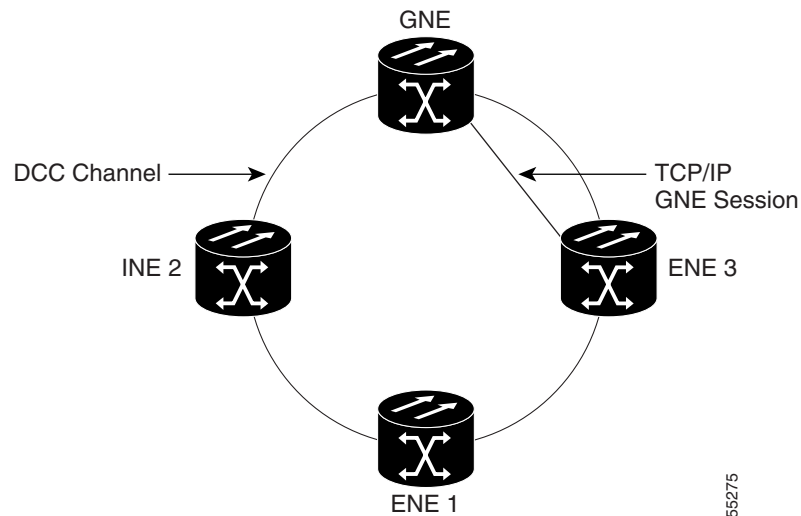

## Log Into a Remote ENE

- Step 1** Telnet or connect through the serial port to Node 0, which will become the GNE.
- Step 2** To connect to the ENE 1 node, enter the TL1 login command using the following input example:

**ACT-USER:NODE1:USERNAME:1234:PASSWORD;**

The GNE forwards the login to ENE 1. After successful login, ENE 1 sends a COMPLD response.

**Step 3** When you are logged into ENE 1, enter the following TL1 login command to connect to ENE 3:

**ACT-USER:NODE3:USERNAME:1234:PASSWORD;**

The GNE forwards the login to ENE 3. After successful login, the ENE 3 sends a COMPLD response.

---

## Forward Commands by Specifying the ENE TID (Node 1 or Node 3)

When you are logged into ENE 1 and ENE 3, enter a command and designate a specific TID. To retrieve the header of Node 1, enter the following command:

**RTRV-HDR:NODE1::1;**

To retrieve the header of Node 3, enter the following command:

**RTRV-HDR:NODE3::3;**

## Receive Autonomous Messages from the Remote ENE

To receive autonomous messages from the remote ENE, you must log into the remote ENE. When you are logged in, you will begin to receive autonomous messages. The source of the message is identified in the header of the message.

## Log Out of a Remote ENE

To disconnect from a remote ENE, you must use the CANC-USER command. Use the following command to disconnect from ENE 1:

**CANC-USER:NODE1:USERNAME:1;**

Use the following command to disconnect from ENE 3:

**CANC-USER:NODE3:USERNAME:3;**

The GNE forwards the logout to the remote ENEs. The GNE/ENE TCP session is closed.

# 2.4 Ring Provisioning

This section provides information and sample procedures for setting up STS or VT circuits over existing path protection and bidirectional line switch ring (BLSR) configurations using TL1, including:

- Path Protection topology
- Path Protection cross-connections
- Ring-to-ring interconnection
- One-way drop and continue

For VTs, add the normal VT Group and VT ID extensions. These examples also assume that the slots/ports have been autoprovisioned (through a plug-in event) and that the ports involved have been placed into the IS state using a port configuration command, for example, ED-OCN.

**Note**

Because the ONS 15454, ONS 15310-CL, and ONS 15600 implement logical path protection, there are no defined east and west ports. Instead, the east STS path for one circuit can exit a different port than the east STS path of another circuit, even though the west STS paths for both circuits might share the same port.

**Note**

The ONS 15310-CL and ONS 15310-MA do not support BLSR.

## 2.5 PCA Provisioning

You can provision or retrieve protection channel access (PCA) cross-connections on two-fiber and four-fiber BLSR topologies at these supported OC rates: OC-12 (two-fiber only), OC-48, and OC-192. The traffic on the protection channel is referred to as extra traffic and has the lowest priority level. Extra traffic will be preempted by any working traffic that requires the use of the protection channel.

In a two-fiber BLSR, the extra traffic is provisioned on the upper half of the bandwidth path. In a four-fiber BLSR, the extra traffic is provisioned on the protect fiber. The PCA provisioning feature allows you to establish the PCA cross-connection on the protection path of the two-fiber BLSR and the protection channel of the four-fiber BLSR only when the query is an explicit request.

There are two PCA connection types: 1WAYPCA and 2WAYPCA. The PCA cross-connection is provisioned only when the user provides an explicit request using the ENT-CRS-STSp/VT1 commands. If the cross-connection is a PCA cross-connection, either 1WAYPCA or 2WAYPCA is shown in the cross-connect type field of the RTRV-CRS-STSp/VT1 command output.

1WAYPCA and 2WAYPCA are only used in the TL1 user interface to provide usability and visibility for the user to specify a PCA cross-connection type in the TL1 cross-connection commands.

The following restrictions apply to PCA provisioning:

- Cisco ONS 15600 does not support BLSR for OC-12.
- The network must be configured as either a two-fiber or four-fiber OC-12, OC-48, or OC-192 BLSR.
- The STS or VT1 path cross-connection can be established with TL1 commands (ENT-CRS-xxx).
- Because the RTRV-CRS-xxx command does not include the optional CTYPE field to specify a connection type, the output result reports the matched cross-connections based on the queried AID(s); therefore, the retrieved cross-connection inventory can include both PCA and non-PCA cross-connections.

### 2.5.1 Provision a PCA Cross-Connection

[Example 2-14](#) shows the input format for provisioning a PCA cross-connection.

**Example 2-14 Provision a PCA Cross-Connect: Input Format**

```
ENT-CRS-<PATH>:[<TID>]:<FROM>,<TO>:<CTAG>:: [<CCT>] [::];
<PATH>::={STS_PATH, VT1}
[<CCT>]::={1WAY, 1WAYDC, 1WAYEN, 2WAY, 1WAYPCA, 2WAYPCA},
{STS_PATH}::={STS1, STS3C, STS6C, STS9C, STS12C, STS24C, STS48C, STS192C}
```

Where:

- STS represents all of the STS bandwidth cross-connections.
- VT1 represents all of the VT1\_5 cross-connections.
- CCT defaults to 2WAY.

[Example 2-15](#) shows an input example of provisioning an STS3C PCA cross-connection.

**Example 2-15 Provision a PCA Cross-Connect: Example**

```
ENT-CRS-ST3C::STS-1-1,STS-2-1:123::2WAYPCA;
```



**Note**

If the cross-connect type (CCT) of this cross-connection provisioning command is either 1WAYPCA or 2WAYPCA, and the NONE value of both <FROM> and <TO> AID is PCA AID, an IIAC (Input, Invalid PCA AIDs) error message is returned.



**Note**

If sending this command with a non-PCA CCT, and one (or two) AIDs is/are the PCA AIDs, an IIAC (The PCA AID Is Not Allowed for the Queried CCT Type) error message is returned.

## 2.5.2 Retrieve a PCA Cross-Connection

Use the input format in [Example 2-16](#) to retrieve a PCA cross-connection.

**Example 2-16 Retrieve a PCA Cross-Connect: Input Format**

```
RTRV-CRS-[<PATH>]: [<TID>]: <AID>: <CTAG> [:::]; <PATH> ::= {STS_PATH, VT1, STS}
```

If PATH is STS, it will retrieve all the STS cross-connections based on the queried AIDs.

<AID>={FacilityAIDs, STSAIDs, VTAIDs, ALL}

[Example 2-17](#) shows the output format of the PCA STSp cross-connection retrieval command.

**Example 2-17 Output Format of PCA STSp Cross-Connect Retrieve Command**

```
"<FROM>, <TO>: 2WAYPCA, STS3C"
```

[Example 2-18](#) shows the output format of the PCA VT cross-connection retrieval command.

**Example 2-18 Output Format of PCA VT Cross-Connect Retrieve Command**

```
"<FROM>, <TO>: 2WAYPCA"
```

## 2.6 FTP Software Download



**Note**

FTP timeout is 30 seconds and is not user-configurable.

The file transfer protocol (FTP) software download feature downloads a software package to the inactive flash partition residing on either the TCC2/TCC2P, XTC, 15310-CL-CTX, CTX2500, or TSC card. FTP software download provides for simplex and duplex TCC2/TCC2P, XTC, 15310-CL-CTX, CTX2500, or TSC card downloads, success and failure status, and in-progress status at 20 percent increments.

## 2.6.1 COPY-RFILE

The COPY-RFILE command downloads a new software package from the location specified by the FTP URL into the inactive flash partition residing on either the TCC2/TCC2P, XTC, 15310-CL-CTX, CTX2500, or TSC card. COPY-RFILE can also be used to backup and restore the database file.



### Note

Since Software Release 5.0, PACKAGE\_PATH is relative to your home directory, instead of being an absolute path from the root directory of the NE. If you want to specify an absolute path, start the path with the string '%2F'.

Input format:

```
COPY-RFILE:[<TID>]:[<SRC>]:<CTAG>::TYPE=<XFERTYPE>,[SRC=<SRC1>],[DEST=<DEST>],[OVWRT=<OVWRT>];
```

where:

- <SRC> is the type of file being transferred.
- <XFERTYPE> is the file transfer protocol.
- <SRC1> specifies the source of the file to be transferred. Only the FTP URL is supported. SRC1 is a string. In a nonfirewall environment, the format for the URL is:

```
“FTP://FTP_USER[:FTP_PASSWORD]]@FTP_HOST_IP[:FTP_PORT]
/PACKAGE_PATH[:TYPE=I]”
```

where:

- FTP\_USER is the user ID used to connect to the computer with the package file.
- FTP\_PASSWORD is the password used to connect to the computer with the package file.
- FTP\_HOST\_IP is the IP address of the computer with the package file. DNS lookup of hostnames is not supported.
- FTP\_PORT defaults to 21.
- PACKAGE\_PATH is the long path name to the package file starting from the home directory of the logged-in user.

In a firewall environment, the host name should be replaced with a list of IP addresses, each separated by an ampersand (@) character. The first IP address should be for the computer where the package file is stored. Subsequent IP addresses are for firewall computers moving outward toward the edge of the network until the final IP address listed is the computer that outside users use to first access the network.

For example, if your topology is:

```
“FTPHOST <-> GNE3 <->GNE2 <-> GNE1 <-> ENE”
```

the FTP URL is:

```
FTP://FTP_USER:FTP_PASSWORD@FTP_HOST_IP@GNE3@GNE2@GNE1/
PACKAGE_PATH
```

- <DEST> specifies the destination of the file to be transferred. The comments for the SRC parameter are also valid here. <DEST> is a string.
- If <OVWRT> is YES, then files are overwritten. Currently only YES is supported. Using a NO value for <OVWRT> will result in an error message.

**Note**

- 
- FTP is the only allowed file transfer method.
  - The use of the SWDL and the extended FTP URL syntax are required by the COPY-RFILE syntax.
- 

## 2.6.2 APPLY

The APPLY command can activate or revert software depending on the version of software loaded on the active and protect flash. An error is returned if the node is attempting to activate to an older software load or trying to revert to a newer software load. If this command is successful, the appropriate flash is selected and the TCC2/TCC2P, XTC, 15310-CL-CTX, CTX2500, or TSC card will reboot.

The input format for the APPLY command is as follows:

```
APPLY:[<TID>]::<CTAG>[::<MEM_SW_TYPE>];
```

where:

- <MEM\_SW\_TYPE> indicates the memory switch action during the software upgrade.

## 2.6.3 REPT EVT FXFR

REPT EVT FXFR is an autonomous message used to report the start, completion, and completed percentage status of the FTP software download. REPT EVT FXFR also reports any failure during the software upgrade including invalid package, invalid path, invalid userid/password, and loss of network connection.

**Note**

---

The “FXFR\_RSLT” is only sent when the “FXFR\_STATUS” is COMPLD.

The “BYTES\_XFRD” is only sent when the “FXFR\_STATUS” is IP or COMPLD.

---

The output format of the REPT EVT FXFR message is as follows:

```
SID DATE TIME
A ATAG REPT EVT FXFR
  “<FILENAME>,<FXFR_STATUS>,[<FXFR_RSLT>],[<BYTES_XFRD>]”
;
```

where:

- <FILENAME> indicates the transferred file path name and is a string. When a package is being transferred between the FTP server and the controller cards, the filename field will contain the string “active”. Following this transfer, if there is a second controller card on the node, the file will be copied over to the second card. While this is happening, REPT EVT FXFR messages will be generated with a filename of “standby”.
- <FXFR\_STATUS> indicates the file transferred status: Start, IP (in progress), or COMPLD.
- <FXFR\_RSLT> indicates the file transferred result: success or failure. <FXFR\_RSLT> is optional.

- <BYTES\_XFRD> indicates the transferred byte count. <BYTES\_XFRD> is a string and is optional.

## 2.6.4 Downloading New Software

The following procedure downloads new software to the TCC2/TCC2P, XTC, 15310-CL-CTX, CTX2500, or TSC card using TL1.

### Download New Software



---

**Note** Only Superusers can download and activate software.

---

- Step 1** Copy the new software package (for example, 15XXX-0340-X02E-2804.pkg) to an FTP host.
- Step 2** Establish a TL1 session with the target NE.
- Step 3** Log in with the ACT-USER command.

**Step 4** Check the working and protect software on the NE by issuing the RTRV-NE-GEN command.

Input example:

```
RTRV-NE-GEN:::1;
```

The output should be similar to the following:

```
VA454-94 1970-01-06 22:22:12
M 1 COMPLD
"IPADDR=10.82.87.94,IPMASK=255.255.255.224,DEFRTR=10.82.86.1,
ETHIPADDR=10.82.87.94,ETHIPMASK=255.255.255.224,NAME=VA454-94,
SWER=3.40.00,LOAD=03.40-002G-14.21,PROTSWVER=4.00.00,
PROTLOAD=04.00-X02G-25.07,DEFDESC=\\"FACTORY DEFAULTS\\""
;
```

**Step 5** Issue the COPY-RFILE command. This command will initiate the download process. See the ["2.6.1 COPY-RFILE" section on page 2-33](#) for command syntax.

In [Example 2-19](#), the package is located in `"/%2FUSR/CET/VINTARA"` in the host 10.77.22.199. The user ID and passwords are TL1 and CISCO454. The directory path of the package is similar to what you will see during an FTP session.

**Example 2-19 Issue the COPY-RFILE Command**

```
COPY-RFILE::RFILE-
PKG:CTAG::TYPE=SWDL, SRC="FTP://TL1:CISCO454@10.77.29.199
/%2FUSR/CET/VINTARA/15454-0340-X02E-2804.PKG";

DEV208 1970-01-10 11:51:57
M CTAG COMPLD
;
```

**Step 6** If any of the parameters are wrong or if the host is not accessible, a REPT EVT FXFR message will report errors. A download failure can result from one or more of the following:

- Directory path of the package is invalid or not found
- Package is invalid
- Package not found on specified path
- User ID/password or host name is invalid
- Host is not accessible
- Firewall user ID/password or host is invalid
- Node rebooted/lost connection during download
- Software download is already in progress
- The node or the host timed out during FTP protocol (see [Example 2-20](#))

**Example 2-20 REPT EVT FXFR when Node or Host Timed Out During FTP Protocol**

```
DEV208 1970-01-10 11:52:02
A 2816.2816 REPT EVT FXFR
" SLOT-11: SFTWDOWN-FAIL, TC, , , , , : \"SOFTWARE DOWNLOAD FAILED\", TCC
;
```

**Step 7** If the download is successful, the REPT EVT FXFR message will report an active start, as shown in [Example 2-21](#).

**Example 2-21 REPT EVT FXFR Message Reporting an Active Start**

```
DEV208 1970-01-10 11:52:15
A 2818,2818 REPT EVT FXFR
  "ACTIVE START"
;
```

- Step 8** A SFTDOWN minor alarm is raised to indicate that the software download is in progress (Example 2-22). The SFTDOWN alarm will clear when the download is complete.

**Example 2-22 SFTDOWN Minor Alarm**

```
DEV208 1970-01--10 11:52:15
* 2817.2817 REPT ALM EQPT
  "SLOT-7:MN,SFTWDOWN,NSA,,,:\"SOFTWARE DOWNLOAD IN PROGRESS\",TCC"
;
```

Use the in-progress status at any time during the software download to verify the RTRV-NE-GEN command (Example 2-23).

**Example 2-23 RTRV-NE-GEN Command**

```
RTRV-NE-GEN

VA454-94 1970-01-06 22:22;12
M 1 COMPLD
  "IPADDR=10.82.87.94,IPMASK=255.255.255.224,DEFRTR=10.82.86.1,
  ETHIPADDR=10.82.87.94,EHTIPMASK=255.255.255.224,NAME=VA454-94,
  SWVER=3.40.00,LOAD=03.40-002G-14-21,PROTSWVER=NONE,
  PROTLOAD=DOWNLOADINPROGRESS,DEFDESC=\":FACTORY DEFAULTS\""
;
```

- Step 9** The download progress is reported by the REPT EVT FXFR message, which will report a message after every 20 percent of download is complete as shown in Example 2-24.

**Example 2-24 REPT EVT FXFR Messages During Software Download**

```
DEV208 1970-01-10 11:53:12
A 2820,2820 REPT EVT FXFR
  "ACTIVE,IP,,20"
;
```

```
DEV208 1970-01-10 11:53:12
A 2820,2820 REPT EVT FXFR
  "ACTIVE,IP,,40"
;
```

```
DEV208 1970-01-10 11:53:12
A 2820,2820 REPT EVT FXFR
  "ACTIVE,IP,,60"
;
```

```
DEV208 1970-01-10 11:53:12
A 2820,2820 REPT EVT FXFR
  "ACTIVE,IP,,80"
;
```

- Step 10** If the TL1 session times out during download or if the user terminates the TL1 session, the download will continue. The download completion can be confirmed by issuing the RTRV-NE-GEN command and verifying the PROTLOAD (Example 2-25).

**Example 2-25 Verifying the PROTLOAD**

```
RTRV-NE-GEN:::1;

VA454-94 1970-01-06 22:22:12
M 1 COMPLD
  "IPADDR=10.82.87.94,IPMASK=255.255.255.224,DEFRTR=10.82.86.1,
  ETHIPADDR=10.82.87.94,EHTIPMASK=255.255.254.0,NAME=VA454-94,
  SWVER=3.40.00,LOAD=03.40-002G-14-21,PROTSWVER=4.00.00,
  PROTLOAD=03.40-X02E-28.04,DEFDESC=\":FACTORY DEFAULTS\ " "
;
```

**Step 11** REPT EVT FXFR confirms the completion of the software download ([Example 2-26](#)).

**Example 2-26 Confirm Download Completion**

```
DEV208 1970-01-10 12:01:16
A 2825,2825 REPT EVT FXFR
  "ACTIVE,COMPLD,SUCCESS"
;
```

**Step 12** The SFTDOWN alarm clears when the download is complete ([Example 2-27](#)).

**Example 2-27 Download is Complete**

```
DEV208 1970-01-10 11:52:15
* 2826,2817 REPT ALM EQPT
  "SLOT-7:CL,SFTWDOWN,NSA,,,,:\ "SOFTWARE DOWNLOAD IN PROGRESS\ ",TCC"
;
```

## 2.6.5 Activating New Software

After the software is successfully downloaded, the new software that resides in the protect load must be activated to run on the NE. The APPLY command can be used to activate and revert depending on the version of the protect software and the newly downloaded software (see the [“2.6.2 APPLY” section on page 2-34](#) for correct APPLY syntax).

### Activate New Software

**Step 1** If the protect software is newer than the working software, activate it as shown:

```
APPLY::1::ACT;

DEV208 1970-01-10 13:40:53
M 1 COMPLD
;
```

An error is reported if a revert is attempted with a newer protect software.

**Step 2** If the APPLY command is successful, log out of the TL1 session using the CANC-USER command:

```
CANC-USER::CISCO15:1;
```

```
VA454-94 1970-01-07 01:18:18
M 1 COMPLD
;
```

After a successful completion of the APPLY command, the NE will reboot and the TL1 session will disconnect. When the NE comes up after the reboot, it will be running the new software. Traffic switches are possible during activation.

## 2.6.6 Remote Software Download/Activation Using the GNE

In a network with Section data communications channel (SDCC)-connected ONS 15454s, ONS 15310-CLs, and ONS 15310-MAs, remote download and activation are possible using the GNE/ENE feature supported in TL1. The GNE must be connected by a LAN and the remaining ENes can download the new software package through fiber from the GNE.

For remote software downloading, complete the steps in the [“Download New Software” procedure on page 2-35](#) and the [“Activate New Software” procedure on page 2-38](#), but ensure that the TID in each command is filled with the ENE node name.

Each GNE can support 20 (TCC2/TCC2P) or 6 (XTC, 15310-CL-CTX, CTX2500) concurrent communication gateway sessions and up to a maximum of 176 (TCC2/TCC2P) or 96 (XTC, 15310-CL-CTX, CTX2500) ENes/GNEs. For more information on TL1 gateway, see the [“2.3 TL1 Gateway” section on page 2-26](#).

After activating the nodes ([Example 2-28](#)), five simultaneous software downloads can be initiated using the COPY-RFILE command with appropriate TIDs, as shown in [Example 2-29](#). All downloads will be independent of each other and download speeds might differ.

### **Example 2-28 Activating the Nodes for Simultaneous Software Downloads**

```
ACT-USER:NODE1:CISCO15:1;
ACT-USER:NODE2:CISCO15:1;
ACT-USER:NODE3:CISCO15:1;
ACT-USER:NODE4:CISCO15:1;
ACT-USER:NODE5:CISCO15:1;
```

### **Example 2-29 Downloading Software on Multiple Nodes Simultaneously**

```
COPY-RFILE:NODE1:RFILE-PKG:CTAG::TYPE=SWDL, SRC="FTP://TL1:
CISCO454@10.77.29.199/USR/CET/VINTARA/15454-0340-X02E-2804.PKG";
```

```
COPY-RFILE:NODE2:RFILE-PKG...
COPY-RFILE:NODE3:RFILE-PKG...
COPY-RFILE:NODE4:RFILE-PKG...
COPY-RFILE:NODE5:RFILE-PKG...
```

To download software to an ENE through a GNE, the FTDD URL in the COPY-RFILE command must be used as shown in [Example 2-30](#). The FTDD parameter has the following format: “FTDD://USERID:PASSWORD@TL1 GNE NODENAME:21”. Prior to Release 6.0, Port 21 is mandatory. In Release 6.0 and later, Port 21 is optional.

**Example 2-30 Downloading Software to an ENE through a GNE**

```
GNE = NODE1
ENE = NODE2
```

```
COPY-RFILE:NODE2:RFILE-PKG:1::TYPE=SWDL, SRC=FTP://USER-ID:PASSWORD@HOST-IP//USERS/JDOE/
15454-XXXX-XXXX-XXXX.PKG, OVWRT=YES, FTTD="FTTD://USERID:PASSWORD@NODE1:21"
```

Individual REPT EVT FXFR messages can be isolated using the node names. RTRV-NE-GEN also requires the individual node names entered in the TID in order to retrieve a specific download status.

Activate the software using the APPLY command (Example 2-31) on all of the nodes using the GNE node.

**Note**

Activate the GNE last, after activating all the ENEs, or else ENE connectivity will be lost when the GNE starts to reboot for activation.

**Example 2-31 Activate the Software Load**

```
APPLY:NODE1::1::ACT;
APPLY:NODE2::1::ACT;
APPLY:NODE3::1::ACT;
APPLY:NODE4::1::ACT;
APPLY:NODE5::1::ACT;
```

## 2.7 Scheduled PM Report

The scheduled performance monitoring (PM) report is a feature that extends the capability of PM reporting for the Cisco ONS 15454, ONS 15310-CL, ONS 15310-MA, and ONS 15600. With a scheduled PM report, the system automatically and periodically generates the PM report of any specified facility or cross-connection.

**Note**

- The current maximum number of schedules allowed to be created for an NE is 1000. If the limit has been reached and the user tries to create more schedules on the NE, the error message “Reach Limits Of MAX Schedules Allowed. Can Not Add More” is returned.
- Identical schedules for an NE are not allowed. Two schedules are considered identical if they have the same AID, MOD2 type, performance monitor type, performance monitor level, location, direction and time period.
- An error message “Duplicate Schedule” is returned if you create a schedule that is a duplicate of an existing schedule. However, if the existing schedule expires (and the parameter <NUMINVL> is equal to zero when retrieved by the RTRV-PMSCHED command, which means that no more performance monitoring reports are to be sent), then the new schedule with the identical parameter will replace the existing schedule.
- When you create a PM schedule, the minimum report interval should not be less than five minutes.
- Refer to the *Cisco ONS SONET TL1 Command Guide* for complete command and autonomous message information.

## 2.7.1 Create a PM Schedule and Receive an Autonomous PM Report

Issue the SCHED-PMREPT-<MOD2> command to create a PM schedule.

Issue the ALW-PMREPT-ALL command to allow the current TL1 session to be able to receive the autonomous PM report.

## 2.7.2 Manage PM Schedules

Use the following commands to manage PM schedules:

- Create a PM schedule by issuing the SCHED-PMREPT-<MOD2> command.
- Delete a PM schedule by issuing the SCHED-PMREPT-<MOD2> command with the <NUMREPT> parameter equal to zero.



---

**Note** The PM schedules created on a facility or a cross-connect will be automatically deleted if the card or the cross-connect are unprovisioned.

---

- Retrieve all the PM schedules created on the node by issuing the RTRV-PMSCHED-ALL command. Retrieve a particular MOD2 type of PM schedule by issuing the RTRV-PMSCHED-<MOD2> command.



---

**Note** The system will not automatically delete the schedules that are expired. For example, assume that a schedule is created to report PM 10 times. After 10 PM reports are sent, the schedule is expired. The expired schedule can be identified by its <NUMINVL> field (equal to zero) in the response of RTRV-PMSCHED.

---

## 2.7.3 Enable or Disable a TL1 Session to Receive Autonomous PM Reports

Enable a TL1 session to receive a scheduled PM report by issuing the ALW-PMREPT-ALL command.



**Note**

---

By default, a TL1 session is disabled to receive PM reports. The ALW-PMREPT-ALL command enables a TL1 user to receive all the scheduled PM reports from the system, regardless of whether or not the schedule is created by this TL1 user or by any other TL1 user.

---

Disable a TL1 session to receive any scheduled PM report by issuing the INH-PMREPT-ALL command.

## 2.8 Bridge and Roll

Bridge and Roll functionality in the Cisco ONS 15454, ONS 15310-CL, ONS 15310-MA, and ONS 15600 allows live traffic to be moved (rolled) from one entity to another. This section provides information and sample procedures for single-rolling, dual-rolling, and protection rolling for one-way or two-way circuits using TL1 commands, including:

- Path Level Rolling—Rolls cross-connections at the VT1.5, STS1, and STSNc rate for all supported time division multiplexing (TDM) drops (OC3, OC12, OC48, and OC192). Individual rolls are done at the Path level.
- Line Level Rolling—Rolls all cross-connections from one port/facility to another port/facility.
- Bulk Rolling—Rolls a subset of cross-connections from one port/facility to another port/facility.

There are two roll modes:

- In automatic mode, the leg to be rolled is automatically dropped upon detection of a valid input signal on the new path.
- In manual mode, the leg to be rolled is retained upon detection of a valid signal on the new path. The leg must be dropped manually.



**Caution**

If you have created a roll on the circuit and it has detected a valid signal, do not cancel it. Cancelling a valid roll will cause a traffic hit of more than 1300 ms. If you want to revert back from a valid roll, complete the roll and use bridge and roll again to roll it back.



**Caution**

Performing bridge and roll on an STS-192c (ONS 15454) might cause a traffic hit of 50 ms.



**Note**

The path width rules for creating circuits apply when rolling circuits. For example, if you roll an STS3c starting at STS#1, you cannot roll it to another port and start it at STS#2. You have to start it at STS#1.

## 2.8.1 Restrictions

The following restrictions apply for bridge and roll using TL1 in this release:

- Rolling is not allowed on electrical cards or Ethernet cards.
- Rolling is not allowed on hairpin circuits.
- Rolling is not allowed on monitor circuits.
- Rolling is not allowed on any cross-connection that is involved in test access.
- Rolling is not allowed on any cross-connection that is involved in cross-connect loopbacks.
- Rolling is not allowed on any port that is involved in facility or equipment loopbacks. This restriction applies to both “roll from” and “roll to.”
- When rolling on a 1+1 protected circuit, the “roll to” cannot be on the protect port of the protection group.
- Rolling on a BLSR protected circuit cannot violate the rules governing BLSR circuits: a circuit that traverses a BLSR must use the same STS number on the ring between source and destination.
- Rolling on a BLSR protected circuit will be denied if there is an existing protection switch on the ring. If the protection switch happens after the roll is initiated, the system will not monitor valid signals on the “roll to” path until the protection switching is cleared.
- Rolling on a path protection protected circuit cannot violate the rules governing path protection circuits: path protection circuits must have one bridge and one selector.
- The bridge and selector of a path protection protected circuit cannot be rolled away.

- In the case of a dual roll on a path protection protected circuit, both roll points have to be on either the working or protect path of the circuit. For example, you cannot specify one roll point on the working path and the other roll point on the protect path of the circuit being rolled.
- When rolling on a path protection protected circuit, the “roll to” cannot be line protected (1+1 or BLSR protected). TL1 can only ensure this on the bridge and selector node, not on the intermediate node.
- When rolling on a mixed protection circuit, the roll points have to be within the same protection domain.
- Rolling using TL1 can be performed on a CTC-created cross-connection.



---

**Note** If a roll is created using TL1, it cannot be edited or deleted by CTC.

---

- Rolling using TL1 can be performed on a TL1 cross-connection.



---

**Note** If a roll is created using CTC, it cannot be edited or deleted by TL1.

---

- If the intermediate path of a circuit is being rolled away to another circuit, the second circuit cannot carry any live traffic.



---

**Note** After a roll is completed, the second circuit will form the new intermediate path of the original circuit.

---

- Rolling cannot be performed on VT tunnels or VT aggregation point (VAP) circuits passing through less than four nodes.

The following restrictions apply for bridge and roll using TL1 VCAT in this release:

- For VCAT circuits that are not open-ended, you cannot change the source or destination of the circuit.
- For open-ended VCAT circuits, you can change the source or destination of the circuit, but only on the open end.

The following restrictions apply for bridge and roll using TL1 common-fiber-routed VCAT circuits in this release:

- Rolling cannot change the common fiber property of a common-fiber-routed VCAT circuit.
- When rolling on a VCAT member circuit, in order not to change the common fiber property of a common-fiber-routed VCAT circuit, you can roll the member from one time slot to a different time slot within the same fiber.

## 2.8.2 Bridge and Roll TL1 Commands

The following commands are used for bridge and roll. Refer to the [Cisco ONS SONET TL1 Command Guide](#) for full command descriptions including input and output formats and examples.

- DLT-BULKROLL-<OCN\_TYPE>

This command deletes or completes an attempted rolling operation. This command supports Line-level rolling and bulk rolling. It cannot be used for Path-level rolling. The rolls that are created using the ENT-BULKROLL-<OCN\_TYPE> command can be deleted using the DLT-BULKROLL-<OCN\_TYPE> command.

- DLT-ROLL-<MOD\_PATH>

This command deletes an attempted rolling operation or completes an attempted rolling operation.

- ED-BULKROLL-<OCN\_TYPE>

This command edits information about rolling traffic from one endpoint to another without interrupting service. This command can use the CMDMDE option to force a valid signal. The only parameter that can be edited is CMDMDE. The time slots cannot be edited. This command supports Line-level rolling and bulk rolling. It cannot be used for Path-level rolling.

- ED-ROLL-<MOD\_PATH>

This command edits information about rolling traffic from one endpoint to another without interrupting service. This command can use the CMDMDE option to force a valid signal. The only parameter that can be edited is CMDMDE. The time slots cannot be edited.

- ENT-BULKROLL-<OCN\_TYPE>

This command enters information about rolling traffic from one endpoint to another without interrupting service. This command supports Line-level and bulk rolling. It cannot be used for single Path-level rolling.

- ENT-ROLL-<MOD\_PATH>

This command enters information about rolling traffic from one endpoint to another without interrupting service. This command supports STS and VT Path-level rolling only.

- RTRV-BULKROLL-<OCN\_TYPE>

This command retrieves roll data parameters. This command supports Line-level rolling and bulk rolling. It cannot be used for Path-level rolling.

- RTRV-ROLL-<MOD\_PATH>

This command retrieves roll data parameters.

## 2.8.3 Two-Way Circuit Single Roll and Dual Roll Procedures

Single roll operation moves either the source or destination of a circuit to a new endpoint: onto the same node or onto a different node. In a single-roll operation, you only choose one roll point during the process.

Dual roll operation reroutes a segment between two roll points of a circuit. The new route can be one of the following:

- A new link (no circuit is required)
- Another circuit (created before or during the bridge and roll process)

In dual roll operation, you choose two roll points during the process.

### Create a Two-Way Circuit Single Roll or Dual Roll

To create a two-way circuit single roll or dual roll, enter the ENT-ROLL-<MOD\_PATH> command or the ENT-BULKROLL-<OCN\_TYPE> command depending on the type of roll you want to perform.

The input formats are as follows:

- **ENT-ROLL-<MOD\_PATH>:[<TID>]:<FROM>,<TO>:<CTAG>:::RFROM=<RFROM>,RTO=<RTO>,RMODE=<RMODE>,[CMDMDE=<CMDMDE>];**
- **ENT-BULKROLL-<OCN\_TYPE>:[<TID>]:<FROM>:<CTAG>:::RTOSTART=<RTOSTART>,[RFROMSTART=<RFROMSTART>],[RFROMEND=<RFROMEND>],RMODE=<RMODE>,[CMDMDE=<CMDMDE>];**

**Step 1** Choose the type of roll that you want to perform and enter the corresponding command:

- For automatic rolling onto the same facility, but different STS (Path roll), use an ENT-ROLL command similar to the following example:

```
ENT-ROLL-ST51:CISCO:STS-1-1-1,STS-2-1-1:1:::RFROM=STS-2-1-1,
RTO=STS-3-1-1,RMODE=AUTO,CMDMDE=FRCD;
```

- For manual rolling onto the same facility, but different STS (Path roll), use an ENT-ROLL command similar to the following example:

```
ENT-ROLL-ST51:CISCO:STS-1-1-1,STS-2-1-1:1:::RFROM=STS-2-1-1,
RTO=STS-3-1-1,RMODE=MAN,CMDMDE=FRCD;
```

- For rolling onto a different facility with the same or different STS (Line roll), use an ENT-BULKROLL command similar to the following example:

```
ENT-BULKROLL-OC48:CISCO:FAC-5-1:123:::RFROMSTART=STS-5-1-1,
RTOSTART=STS-6-1-1,RMODE=AUTO,CMDMDE=FRCD;
```

This command will roll all the STS and VT paths to a facility on Slot 6 with the same STS as shown in [Table 2-7](#).

**Table 2-7 Two-Way Circuit Single or Dual Line Roll with ENT-BULKROLL**

Paths	Before Roll	After Roll
STS#1	STS-5-1-1	STS-6-1-1
STS#2	STS-5-1-2	STS-6-1-2
VT#1 on STS#3	VT1-5-1-3-1-1	VT1-6-1-3-1-1
VT#2 on STS#3	VT1-5-1-3-2-4	VT1-6-1-3-2-4
STS#4	STS-5-1-4	STS-6-1-4
STS#5	STS-5-1-5	STS-6-1-5
VT#3 on STS#6	VT1-5-1-6-1-1	VT1-6-1-6-1-1

- For rolling a set of circuits onto a different facility (bulk roll), use an ENT-BULKROLL command similar to the following example:

```
ENT-BULKROLL-OC48:CISCO:FAC-5-1:123:::RFROMSTART=STS-5-1-1,
RTOSTART=STS-6-1-1,RFROMEND=STS-5-1-4,RMODE=AUTO,CMDMDE=FRCD;
```

This command will roll the paths shown in [Table 2-8](#).

**Table 2-8 Two-Way Circuit Single or Dual Bulk Roll with ENT-BULKROLL**

Paths	Before Roll	After Roll
STS#1	STS-5-1-1	STS-6-1-1
STS#2	STS-5-1-2	STS-6-1-2
VT#1 on STS#3	VT1-5-1-3-1-1	VT1-6-1-3-1-1
VT#2 on STS#3	VT1-5-1-3-2-4	VT1-6-1-3-2-4
STS#4	STS-5-1-4	STS-6-1-4

**Step 2** If you performed a manual roll, you must confirm the circuit is valid by issuing the RTRV-BULKROLL-<OCN\_TYPE> command:

Input format:

**RTRV-BULKROLL-<OCN\_TYPE>:[<TID>]:<SRC>:<CTAG>;**

Input example:

**RTRV-BULKROLL-OC12:CISCO:FAC-3-1:1;**

## 2.8.4 One-Way Circuit Single Roll and Dual Roll Procedures

Single roll operation moves either the source or destination of a circuit to a new endpoint: onto the same node or onto a different node. In single roll operation, you only choose one roll point during the process.

Dual roll operation reroutes a segment between two roll points of a circuit. In dual roll operation, you choose two roll points during the process. The new route can be one of the following:

- A new link (no circuit is required)
- Another circuit (created before or during the bridge and roll process)

### Create a One-Way Circuit Single Roll

To create a one-way circuit single roll, enter the ENT-ROLL-<MOD\_PATH> command or the ENT-BULKROLL-<OCN\_TYPE> command depending on the type of roll you want to perform.

Input formats:

- **ENT-ROLL-<MOD\_PATH>:[<TID>]:<FROM>,<TO>:<CTAG>:::RFROM=<RFROM>,RTO=<RTO>,RMODE=<RMODE>,[CMDMDE=<CMDMDE>];**



**Note** For a one-way destination roll, the roll mode (RMODE) must be manual (MAN).

- **ENT-BULKROLL-<OCN\_TYPE>:[<TID>]:<FROM>:<CTAG>:::RTOSTART=<RTOSTART>,[RFROMSTART=<RFROMSTART>],[RFROMEND=<RFROMEND>],RMODE=<RMODE>,[CMDMDE=<CMDMDE>];**

**Step 1** Choose which type of roll you want to perform and enter the corresponding command:

- For automatic rolling onto the same facility, but different STS (path roll), use an ENT-ROLL command similar to the following example:  
**ENT-ROLL-STIS1:CISCO:STS-1-1-1,STS-2-1-1:1:::RFROM=STS-2-1-1,  
RTO=STS-3-1-1,RMODE=AUTO,CMDMDE=FRCD;**
- For manual rolling onto the same facility, but different STS (path roll), use an ENT-ROLL command similar to the following example:  
**ENT-ROLL-STIS1:CISCO:STS-1-1-1,STS-2-1-1:1:::RFROM=STS-2-1-1,  
RTO=STS-3-1-1,RMODE=MAN,CMDMDE=FRCD;**
- For rolling onto a different facility with the same or different STS (line roll), use an ENT-ROLL command similar to the following example:  
**ENT-ROLL-STIS1:CISCO:STS-1-1-1,STS-2-1-1:1:::RFROM=STS-2-1-1,  
RTO=STS-3-1-1,RMODE=AUTO,CMDMDE=FRCD;**

This command will roll all the STS and VT paths to a facility on Slot 6 with the same STS as shown in [Table 2-9](#).

**Table 2-9** One-Way Circuit Single Line Roll with ENT-BULKROLL

Paths	Before Roll	After Roll
STS#1	STS-5-1-1	STS-6-1-1
STS#2	STS-5-1-2	STS-6-1-2
VT#1 on STS#3	VT1-5-1-3-1-1	VT1-6-1-3-1-1
VT#2 on STS#3	VT1-5-1-3-2-4	VT1-6-1-3-2-4
STS#4	STS-5-1-4	STS-6-1-4
STS#5	STS-5-1-5	STS-6-1-5
VT#3 on STS#6	VT1-5-1-6-1-1	VT1-6-1-6-1-1

- For rolling a set of circuits onto a different facility (bulk roll), use an ENT-BULKROLL command similar to the following example:  
**ENT-BULKROLL-OC48:CISCO:FAC-5-1:123:::RTOSTART=STS-6-1-1,  
RFROMSTART=STS-5-1-1,RFROMEND=STS-5-1-4,RMODE=AUTO,CMDMDE=FRCD;**

This command will roll the paths shown in [Table 2-10](#).

**Table 2-10** One-Way Circuit Single Bulk Roll with ENT-BULKROLL

Paths	Before Roll	After Roll
STS#1	STS-5-1-1	STS-6-1-1
STS#2	STS-5-1-2	STS-6-1-2
VT#1 on STS#3	VT1-5-1-3-1-1	VT1-6-1-3-1-1
VT#2 on STS#3	VT1-5-1-3-2-4	VT1-6-1-3-2-4
STS#4	STS-5-1-4	STS-6-1-4

**Step 2** If you performed a manual roll, you must confirm that the circuit is valid by issuing the RTRV-BULKROLL-<OCN\_TYPE> command.

Input format:

**RTRV-BULKROLL-<OCN\_TYPE>:[<TID>]:<SRC>:<CTAG>;**

Input example:

**RTRV-BULKROLL-OC12:CISCO:FAC-3-1:1;**

## Create a One-Way Circuit Dual Roll

In this procedure, both the source and destination nodes are rolled. There are two types of dual rolls:

- Dual roll for a single circuit within the same facilities but to a different time slot
- Dual roll for a single circuit from one span card to another span card

**Step 1** Determine the type of roll that you want to perform on the source node and follow the steps in the [“Create a One-Way Circuit Single Roll”](#) section on page 2-46.

**Step 2** Determine the type of roll that you want to perform on the destination node and follow the steps in the [“Create a One-Way Circuit Single Roll”](#) section on page 2-46.

## 2.8.5 Protection Rolling Procedures

To perform protection rolls, follow the procedures in the [“2.8.3 Two-Way Circuit Single Roll and Dual Roll Procedures”](#) section on page 2-44 and the [“2.8.4 One-Way Circuit Single Roll and Dual Roll Procedures”](#) section on page 2-46.



### Note

Before performing a protection roll, either from one protection group to another or within the same protection group, the protection group must already be provisioned.

Table 2-11 shows what kind of protection rolls are supported from one domain to another. An X indicates the roll is allowed. A dash indicates that the roll is not allowed.

**Table 2-11 Supported Protection Rolls**

Roll From Domain	Roll To Domain				
	BLSR	PCA	1+1	Path Protection	Unprotected
BLSR	X	X	X	—	X
PCA	X	X	X	—	X
1+1	X	X	X	—	X
Path Protection	—	—	—	X	—
Unprotected	X	X	X	—	X

## 2.9 1:N Low-Density to 1:N High-Density Upgrade

In the Cisco ONS 15454, DS1 electrical cards can be upgraded to DS1/E1-56 high-density cards using TL1. This procedure can be performed only when logged in as a Superuser.



### Note

- Protect cards must be upgraded before working cards because working cards cannot have more capabilities than their protect card.
- You cannot upgrade electrical cards from low-density to high-density if the low-density electrical cards are installed in Slots 4, 5 or 6 on the A side or 12, 13 or 14 on the B side of the shelf. Only cards in slots 1, 2, 16 and 17 can be upgraded to high-density electrical cards.
- The following limitations apply when upgrading low-density electrical cards to high-density electrical cards:
  - The protect card must be in a protection group.
  - The protect card must not protect any low-density electrical cards on Slots 4, 5, or 6 if on the A-Side of the shelf, or Slots 12, 13, or 14 if on the B-Side of the shelf.
- Perform this procedure on low-density cards that are already in 1:N protection.

**Step 1** On the protect card, change the card type from low-density to high-density.

Input format:

**CHG-EQPT:[<TID>]:<AID>:<CTAG>::<NEW\_EQPT\_TYPE>;**

Input example:

**CHG-EQPT::SLOT-15:123::DS1-E1-56;**

**Step 2** Physically remove the low-density protect card and insert the high-density protect card.

**Step 3** Switch the traffic from the working card to the protect card.

Input format:

**SW-TOPROTN-EQPT:[<TID>]:<AID>:<CTAG>::[<MODE>],[<DIRN>];**

Input example:

**SW-TOPROTN-EQPT::SLOT-16:123::FRCD,SLOT-15,BTH;**

**Step 4** On the working card, change the card type from low-density to high-density.

Input format:

**CHG-EQPT:[<TID>]:<AID>:<CTAG>::<NEW\_EQPT\_TYPE>;**

Input example:

**CHG-EQPT::SLOT-16:123::DS1-E1-56;**

**Step 5** Physically remove the working low-density card and insert the high-density card.

**Step 6** Switch the traffic back onto the working high-density card.

Input format:

```
SW-TOWKG-EQPT:[<TID>]:<AID>:<CTAG>::[<MODE>],[<DIRN>];
```

Input example:

```
SW-TOWKG-EQPT::SLOT-16:123::FRCD,BTH;
```

**Step 7** Repeat these steps to upgrade the other low-density card in the protection group.

---

## 2.10 Remote Monitoring-Managed PMs

This section describes the retrieval, threshold setting, threshold crossing alerts (TCAs) and scheduled PM reporting for all the remote monitoring (RMON)-managed PM data in the Cisco ONS 15454, ONS 15310-CL, ONS 15310-MA, and ONS 15600.



### Note

Cisco ONS 15600 does not support RMONTH commands. For ONS 15600, RMON counts can be retrieved using TL1 commands, but RMON thresholds cannot be set using TL1.

---

The cards that support RMON PMs include: G1K-4, CE-1000-4, ML1000-2/ML100T-12, FC\_MR-4, ASAP-4, MXP\_MR\_2.5G/MXPP\_MR\_2.5G, and ML-100T-8/CE-100T-8. The PM types for these cards include Ethernet statistic types defined in standard Simple Network Management Protocol (SNMP)/RMON MIBs, and also include other statistic types managed by RMON, for example, the Fibre Channel statistic types.

When creating an RMON threshold, there are two threshold values that need to be specified. The first threshold is the rising threshold and the other is the falling threshold. There are other parameters that need to be specified when creating the RMON threshold, for example, the startup type and the sample type.



### Note

There can be more than one threshold defined for each RMON statistic type.

---

The current bucket is not defined by the RMON. RMON-managed PM only shows the history data of the PMs and the data accumulated since the last time the counters are cleared (RAW-DATA).

In the RMON TCA, the accumulation time period is not the predefined PM bucket accumulation time, such as 15-MIN or 1-DAY. It can be any integer (any time greater than 10 seconds) that is defined when creating the RMON threshold.



### Note

For platform-specific PM information, refer to the Procedure Guide and Reference Manual of that platform.

---

## 2.10.1 RTRV-PM-<MOD2>

The RTRV-PM-<MOD2> command retrieves the RMON-managed PMs.

The TL1 modifiers FSTE/GIGE/POS are used to retrieve the RMON-managed Ethernet PMs if the Ethernet port is an FSTE/GIGE/POS port type. The FC modifier retrieves the RMON-managed Fibre Channel PMs.

There are three accumulation time periods for RMON statistics: 1-MIN, 1-HR, and RAW-DATA. For RMON-managed PMs, only history PM buckets and RAW-DATA are supported and there is no current bucket defined for RMON-managed PMs. When RAW-DATA is specified in the input of RTRV-PM, the date and time specified in the input will be ignored. The MONDATE and MONTIME in the output will be the last time the counters were cleared. RAW-DATA will be the default TPER value for RMON-managed PM retrieval.

Because RMON PM only supports the history data if the accumulation time period is 1-MIN, 15-MIN, 1-HR, or 1-DAY, you must specify the correct history PM bucket for the RTRV-PM command to succeed.

When retrieving PM, if an unsupported MONYYPR is specified, an error message will be returned.

Currently there is no support of LOCN (location) and DIRN (direction) for RMON-managed data statistics.

### Input Format

```
RTRV-PM-<MOD2>:[<TID>]:<AID>:<CTAG>::[<MONTYPE>],[<MONLEV>],[<ISTM>],
[<DIRECTION>],[<TPER>],[<DATE>],[<TIME>;
```

### Input Example

```
RTRV-PM-GIGE:TID:FAC-2-1:123::ETHERSTATSOCTETS,,,1-MIN,04-11,12-45;
RTRV-PM-GIGE:TID:FAC-2-1:123::,,,RAW-DATA;
```

### Output Format

```
SID DATE TIME
M CTAG COMPLD
“<AID>,[<AIDTYPE>]:<MONTYPE>,<MONVAL>,[<VLDTY>],[<LOCN>],
[<DIRECTION>],[<TPER>],[<MONDAT>],[<MONTM>]”
;
```

### Output Example

```
TID-000 1998-06-20 14:30:00
M 001 COMPLD
“FAC-2-1,GIGE:etherStatsOctets,21,COMPL,,,1-MIN,04-11,12-45”
;
```

[Table 2-12](#) shows the error messages associated with the RTRV-PM-<MOD2> command.

**Table 2-12** Error Messages for RTRV-PM-<MOD2>

Error Code	Description	Scenario When the Error Message is Sent
IDNV	TMPER Type Not Supported	The TMPER parameter specified is not applicable for the MOD2 type. For example, 1-MIN is not applicable for OC48 PM types.
IDNV	Current Interval Not Supported For RMON PMs	The current interval is specified by default, or is explicitly specified by MONDAT/MONTM, when the TMPER is 1-MIN, 15-MIN, 1-HR, or 1-DAY.

## 2.10.2 ENT-RMONTH-<MOD2\_RMON>

The ENT-RMONTH-<MOD2\_RMON> command creates a threshold type (an entry in the RMON alarm table) for an RMON statistic, for the RMON-managed PMs. An event (TCA) is generated and reported when the threshold is crossed in the appropriate direction during the sampled time period.

More than one threshold can be created by using different parameters (rising/falling threshold), for each MONTYPE.

This command applies to G1000, GIGE, FSTE, POS, and FC data objects.

### Input Format

```
ENT-RMONTH-<MOD2>:[<TID>]:<AID>:<CTAG>::<MONTYPE>,,,<INTVL>:RISE=<RISE>,
FALL=<FALL>,[SAMPLE=<SAMPLE>],[STARTUP=<STARTUP >][:];
```

### Input Example

The following example creates an entry in the RMON threshold table for the etherStatsOctets statistic type with an interval equal to 100 seconds, rising threshold of 1000, falling threshold of 100, DELTA sampling type, and startup type of RISING-OR-LTING.

```
ENT-RMONTH-GIGE:CISCO:FAC-2-1:123::ETHERSTATSOCTETS,,,100:RISE=1000,
FALL=100,SAMPLE=DELTA,STARTUP=RISING-OR-LTING;
```

[Table 2-13](#) shows the error messages associated with the ENT-RMONTH-<MOD2\_RMON> command.

**Table 2-13** Error Messages for ENT-RMONTH-<MOD2\_RMON>

Error Code	Description	Scenario When the Error Message is Sent
IDNV	Invalid Interval	The input interval value is less than 10.
IDRG	Invalid Threshold Value	The rising/falling threshold is less than 0, or the falling threshold is greater than or equal to rising threshold.
IDNV	Invalid MONTYPE value	The MONTYPE is not applicable to the data type (represented by the MOD2).
IIDT	Cannot Create More RMON Threshold	The number of RMON thresholds created has reached the maximum (256).
IIDT	Duplicate RMON Threshold	There already is a threshold created with the exact same parameters.

## 2.10.3 DLT-RMONTH-<MOD2\_RMON>

The DLT-RMONTH-<MOD2\_RMON> command deletes a threshold type (an entry in the RMON alarm table) created for a MONTYPE (RMON statistic type). Because there can be multiple thresholds created for a particular MONTYPE, you must specify all the necessary parameters for the threshold in order to identify the particular threshold to be deleted.

This command applies to G1000, GIGE, FSTE, POS, and FC data objects.

### Input Format

```
DLT-RMONTH-<MOD2>:[<TID>]:<AID>:<CTAG>::<MONTYPE>,,,<INTVL>:RISE=<RISE>,
FALL=<FALL>,[SAMPLE=<SAMPLE>],[STARTUP=<STARTUP>][:];
```

### Input Example

The following example deletes an entry in the RMON threshold table for the etherStatsOctets statistic type, with an interval equal to 100 seconds, rising threshold of 1000, falling threshold of 100, DELTA sampling type, and startup type of BOTH.

```
DLT-RMONTH-GIGE:CISCO:FAC-2-1:123::ETHERSTATSOCTETS,,,<INTVL>:RISE=1000,FALL=100,
SAMPLE=DELTA,STARTUP=BOTH;
```

Table 2-14 shows the error messages associated with the DLT-RMONTH-<MOD2\_RMON> command.

**Table 2-14 Error Messages for DLT-RMONTH-<MOD2\_RMON>**

Error Code	Description	Scenario When the Error Message is Sent
IDNV	Invalid Interval	The input interval value is less than 10.
IDRG	Invalid Threshold Value	The rising/falling threshold is less than 0, or the falling threshold is greater than or equal to rising threshold.
IDNV	Invalid MONTYPE value	The MONTYPE is not applicable to the data type (represented by the MOD2).
SROF	RMON Threshold Does Not Exist	The RMON threshold you are trying to delete does not exist.

## 2.10.4 RTRV-RMONTH-<MOD2\_RMON>

The RTRV-RMONTH-<MOD2\_RMON> command retrieves the thresholds defined in the RMON alarm table.

### Input Format

```
RTRV-RMONTH-<MOD2>:[<TID>]:<AID>:<CTAG>::<MONTYPE>],,,
[<INTVL>]:[RISE=<RISE>],[FALL=<FALL>],[SAMPLE=<SAMPLE>],[STARTUP=<STARTUP>];
```

### Input Example

The following example retrieves all the thresholds defined in the RMON threshold table for the etherStatsOctets statistics type.

```
RTRV-RMONTH-GIGE:TID:FAC-2-1:123::ETHERSTATSOCTETS;
```

The following example retrieves all the thresholds for the etherStatsOctets statistics type with the DELTA sampling type and RISING startup type defined in the RMON threshold table.

```
RTRV-RMONTH-GIGE:CISCO:FAC-2-1:123::ETHERSTATSOCTETS:SAMPLE=DELTA,
STARTUP=RISING;
```

**Output Format**

```
SID DATE TIME
M CTAG COMPLD
"<AID>,[<AIDTYPE>]:<MONTYPE>,,[<INTVL>]:INDEX=<INDEX>,RISE=<RISE>,
FALL=<FALL>,SAMPLE=<SAMPLE>,STARTUP=<STARTUP>"
;
```

**Output Example**

```
TID-000 1998-06-20 14:30:00
M 001 COMPLD
"FAC-2-1,GIGE:ETHERSTATSOCTETS,,,100:INDEX=2,RISE=1000,FALL=100,
SAMPLE=DELTA,STARTUP=RISING"
;
```

Table 2-15 shows the error messages associated with the DLT-RMONTH-<MOD2\_RMON> command.

**Table 2-15 Error Messages for RTRV-RMONTH-<MOD2\_RMON>**

Error Code	Description	Scenario When the Error Message is Sent
IDNV	Invalid Interval	The input interval value is less than 10.
IDRG	Invalid Threshold Value	The rising/falling threshold is less than 0, or the falling threshold is greater than or equal to rising threshold.
IDNV	Invalid MONTYPE value	The MONTYPE is not applicable to the data type (represented by the MOD2).
SROF	RMON Threshold Does Not Exist	The RMON threshold you are trying to delete does not exist.

## 2.10.5 REPT EVT <MOD2ALM> for Threshold Crossing Events

The REPT EVT <MOD2ALM> autonomous message reports the threshold crossing event for the RMON statistics. The high threshold (HT) designator is generated when crossing the RISING threshold. The low threshold (LT) is generated when crossing the FALLING threshold.

The table index for thresholds in the RMON alarm table is enclosed in the text of the TCA description. This table index also appears in the output of the RTRV-RMONTH command. You can retrieve additional information regarding the threshold that generates the TCA by issuing the RTRV-RMONTH command and comparing the output with corresponding table index.

**Output Format**

```
SID DATE TIME
M CTAG COMPLD
"<AID>:<CONDTYPE>,[<CONDEFF>],[<OCRDAT>],[<OCRTM>],[<LOCN>],[<MONVAL>],
[<THLEV>],[<TMPER>]:[<DESC>],[<AIDDET>]"
;
```

**Output Example**

```

VA454-23 2000-02-20 08:47:03
A 512.512 REPT EVT G1000
  "FAC-2-1,G1000:T-ETHERSTATSOCTETS-HT,TC,09-30,23-59-59,,1003,
  1000,:"RMON THRESHOLD CROSSING ALARM # 1 \",G1000-4"
;

```

**2.10.6 INIT-REG-<MOD2>**

This command initializes the PM registers.

This command applies to G1K-4, GIGE, FSTE, and FC data objects.

Only RAW-DATA is allowed to be specified for TPER because no history data will be cleared for RMON-managed PMs by INIT-REG-<MOD2>.

**2.10.7 SCHED-PMREPT-<MOD2>**

This command schedules/reschedules the NE to report the performance monitoring data.

The three accumulation time periods form RMON statistics are: 1-MIN, 1-HR, and RAW-DATA.

**2.10.8 RTRV-PMSCHED-<MOD2>**

This command retrieves the RMON statistics reporting schedule that was set for the NE by the SCHED-PMREPT-<MOD2> command.

The LOCN parameter is optional in the output of RTRV-PMSCHED-<MOD2>, and no LOCN information will be given in the output of RTRV-PMSCHED for RMON PM schedule.

**2.10.9 REPT PM <MOD2>**

Reports autonomous monitoring statistics as a result of the schedule created by SCHED-PMREPT-<MOD2>.

The LOCN parameter is optional in the output of REPT PM <MOD2> message, and no LOCN information will be given in the output of REPT PM <MOD2>.

**2.10.10 REPT DBCHG**

Reports any changes on the NE that result from issuing the following commands:

- ENT-RMONTH-<MOD2>
- DLT-RMONTH-<MOD2>

Also reports when an RMON PM schedule is created or deleted through the SCHED-PMREPT-<MO2> command.

## 2.10.11 MONTYPE and CONDEF Defined for TCA

The names of Ethernet and Fibre Channel MONTYPES are defined exactly as they are defined in the corresponding SNMP MIB statistics group. For example, etherStatsUndersizePkts will be used as the name for the same RMON statistics defined in request for comment (RFC)1757.

Unlike the PM parameters of other SONET entities (such as STS path and OCn), there are two CONDEFs defined for the TCAs of each RMON-managed statistics type: Ethernet or Fibre Channel MONTYPE. One CONDEF is for the rising threshold, and the other is for the falling threshold. For example, there are two CONDEFs for the etherStatsUndersizePkts statistics type: T-etherStatsUndersizePkts-HT for the rising threshold, and T-etherStatsUndersizePkts-LT for the falling threshold.

**Note**

For platform-specific PM information, refer to the Procedure Guide and Reference Manual of that platform.

## 2.10.12 Enumerated Types

### 2.10.12.1 TMPER

Table 2-16 shows the possible TMPER values.

**Table 2-16** *TMPER Type*

Values	Description
1-DAY	Performance Parameter Accumulation Interval Length - Every 24 Hours. For SONET PM data (line/session/path), only 1 day of history data is available. For RMON managed data statistics, 7 days of history data are available.
15-MIN	Performance Parameter Accumulation Interval Length - Every 15 Minutes. 32 15-MIN buckets of history data are available for this accumulation interval length.
1-MIN	Performance Parameter Accumulation Interval Length - Every 1 minute. Only applicable to RMON statistics. 60 minutes of history data are available for this accumulation interval length.
1-HR	Performance Parameter Accumulation Interval Length - Every 1 Hours. Only applicable to RMON statistics. 24 hours of history data are available for this accumulation interval length.
RAW-DATA	The data shown is accumulated starting from the last time the counters are cleared. This is only applicable to RMON-managed PMs.

### 2.10.12.2 SAMPLE\_TYPE

SAMPLE\_TYPE (Table 2-17) describes how the data will be calculated during the sampling period.

**Table 2-17** *SAMPLE\_TYPE*

Value	Description
ABSOLUTE	Comparing directly.
DELTA	Comparing with the current value of the selected variable subtracted by the last sample.

### 2.10.12.3 STARTUP\_TYPE

STARTUP\_TYPE (Table 2-18) indicates whether an event will be generated when the first valid sample is crossing the rising or falling threshold.

**Table 2-18** *STARTUP\_TYPE*

Value	Description
RISING	Generate the event when the sample is greater than or equal to the rising threshold.
FALLING	Generate the event when the sample is smaller than or equal to the falling threshold.
RISING-OR-LTING	Generate the event when the sample is crossing the rising or falling threshold.

## 2.10.13 Notes for DWDM Card Types

The PM for client port and/or optical channel (OCH) can include both the RMON-managed PM and the SONET PM when the client payload is provisioned as 1GFC, 2GFC, 10GFC, 1GFICON, 2GFICON, GIGE, or 10GIGE for the following cards:

- MXP\_2.5G\_10G
- TXP\_MR\_10G
- TXP\_MR\_2.5G
- TXP\_MR\_10E
- MXP\_MR\_2.5G

### 2.10.13.1 Client Port of DWDM Cards

When the client port of a dense wavelength division multiplexing (DWDM) card is provisioned as 1GFC, 2GFC, 10GFC, 1GFICON, 2GFICON, GIGE, or 10GIGE, the applicable PM for the client port includes both the RMON-managed PM and the SONET PM. Therefore, the behavior of the RTRV-PM-<MOD2>, INIT-REG-<MOD2>, and SCHED-PMREPT-<MOD2> commands is different from the Ethernet or Fibre Channel port of the other cards where only RMON PM is applicable. The differences include:

- LOCN and DIRN parameters are applicable to the RTRV-PM-<MOD2>, INIT-REG-<MOD2>, and SCHED-PMREPT-<MOD2> commands because they are applicable to the SONET optics PM. When the LOCN or DIRN parameter is specified, it only applies to the SONET optics PM.
- Because 1-MIN, 1-HR, or RAW-DATA are not applicable to the SONET optics PM, no SONET optics PM would be returned in the output of RTRV-PM. If RAW-DATA is specified in the input of the INIT-REG command, no SONET optics PM counter will be cleared.

- When the accumulation time period is specified as 15-MIN or 1-DAY and the PM history bucket is specified as 0 (current bucket), only the SONET optics PM will be returned in the output of the RTRV-PM command. No RMON-managed PM will be included in the output of the RTRV-PM command because the RMON PM does not have current bucket.
- A SONET optics PM MONTYPE cannot be specified in the input of the INIT-REG command. Only the SONET optics PM counters will be cleared. When the ALL MONTYPE is specified, both the RMON and the SONET optics PM counters will be cleared.
- The commands used to manage RMON thresholds (ENT-RMONTH, DLT-RMONTH, and RTRV-RMONTH) are only applicable to the RMON PM of the client port. The SONET optics PM thresholds of the client port are still managed by the SET-TH and RTRV-TH commands. For example, if the client port type of an MXP\_MR\_2.5G card is provisioned as GIGE, the following command would be used to create an RMON threshold:

```
ENT-RMONTH-GIGE::FAC-2-1-1:1::IFINOTETS,,,,1000:RISE=1000,FALL=900;
```

In the same client port, the following command would be used to set the SONET the optics PM threshold:

```
SET-TH-GIGE::FAC-2-1-1:1LBCL-MIN,0.2;
```

### 2.10.13.2 OCH Port of DWDM Cards

The optical channel (OCH) port of the TXP\_MR\_10G and TXP\_MR\_10E cards include the RMON-managed 8B10B PM as well as the other SONET PMs, when their client port is provisioned as GIGE, 10GIGE, 1GFC, 2GFC, or 10GFC.

The RTRV-PM-OCH, INIT-REG-OCH, SCHED-PMREPT-OCH, and REPT PM OCH commands have behaviors similar to those mentioned in the [“2.10.13.1 Client Port of DWDM Cards”](#) section on [page 2-57](#).

## 2.11 Rules for Framing Type Autoprovisioning in CTC Versus TL1

The DS3, DS3E, DS3XM, DS3i, and DS1 cards can autosense framing and set the format accordingly; however, this framing autosense feature can only be set using CTC. Use CTC to set the frame format (FMT) attribute on DS3, DS3E, DS3XM, DS3i, and DS1 cards to autoprovision. The FMT field will blank out for a few seconds while the card is determining the framing mode received by that particular port. The FMT field is set accordingly to unframed, M23, or CBit. If the card is not present (preprovisioned), setting the FMT field to autoprovision will result in the FMT field defaulting to unframed.

The TL1 interface does not support the autoprovision option for the DS3, DS3E, DS3XM, DS3i, and DS1 cards; it only supports unframed, M23, or CBit. If autoprovision is selected from CTC and at the same time the TL1 command RTRV-T3 is issued, the TL1 output will indicate the FMT field as unframed during the time period that the card (if present) is autosensing the frame format. If the card is not present (preprovisioned), the response of the RTRV-T3 command (after CTC sets the FMT to autoprovision) will indicate the FMT field as unframed.

## 2.12 Provisioning Rules for Transponder and Muxponder Cards

This section provides provisioning rules associated with the following cards and their pluggable port modules (PPMs):

- MXP\_2.5G\_10G
- TXP\_MR\_10G
- TXP\_MR\_2.5G
- TXPP\_MR\_2.5G
- MXP\_2.5G\_10E
- TXP\_MR\_10E
- MXP\_MR\_2.5G
- MXPP\_MR\_2.5G

### 2.12.1 PPM Provisioning Rules

PPMs must be provisioned. Use the ENT-EQPT command to provision PPMs. For example, to provision the first PPM on Slot 2, use the following command:

```
ENT-EQPT::PPM-2-1:100::PPM-1PORT;
```

To delete PPM provisioning, use the DLT-EQPT command.

### 2.12.2 Payload Provisioning Rules

Use the following rules when provisioning payload:

- PPM must first be provisioned.
- Changing the payload data type requires:
  - All ports being edited must be in the Out-of-Service and Management, Disabled (OOS-MA,DSBLD) state because this change is service affecting.
  - All ports being edited must not have any DCC terminations.
  - All ports being edited must not be part of any timing source.
  - The section trace mode of all ports being edited must be OFF.
  - For all regeneration and retiming (2R) payload types, trunk ports must not have GCC termination or optical transport network/forward error correction (OTN/FEC) enabled.
  - The payload cannot be changed if any ports being edited are part of a Y-cable protection group.
  - Only the TXP card can be used for the 10GIGE payload. Termination mode must be set to TRANSPARENT-AIS or TRANSPARENT-SQUELCH (TRANSPARENT-SQUELCH is only supported on TXP\_MR\_10E).
- To set the payload to a speed other than OC-3, OC-12, OC-48, or OC-192, the termination mode must be set to TRANSPARENT-AIS or TRANSPARENT-SQUELCH (TRANSPARENT-SQUELCH is only supported on TXP\_MR\_10E). For Fibre Channel cards and all 2R payload types, the termination mode is not applicable and must be set to TRANSPARENT (AIS or SQUELCH).

- Changing payload while in a regeneration group requires first unprovisioning the regeneration group, unprovisioning the payload, reprovisioning the payload, and reprovisioning the regeneration group.

The TL1 commands for provisioning payload are:

- ENT-(OCn, nGIGE, nGFC, 2R)
- DLT-(OCn, nGIGE, nGFC, 2R)
- ED-(OCn, nGIGE, nGFC, 2R)

## 2.12.3 OC-N Payload Provisioning Parameters

SONET payloads are supported by DWDM cards according to [Table 2-19](#). These payloads are configurable only for the Section and Line layers. STS layers cannot be provisioned or retrieved.

**Table 2-19** Payload/Card Mode Support

Card Type	Payload	Card Mode
TXP_MR_10G	OC192	DWDM-LINE
	10GIGE	DWDM-SECTION DWDM-TRANS-AIS With REGEN group: DWDM-TRANS-AIS
MXP_2.5G_10G	OC48	DWDM-LINE DWDM-SECTION DWDM-TRANS-AIS
TXP_MR_2.5G and TXPP_MR_2.5G	1GIGE, 1GF, 1GFICON, 2GFICON, ESCON, ISC1, ISC3, ETRCLO, DV6000, HDTV, D1VIDEO	With REGEN group: DWDM-TRANS-AIS Must be DWDM-TRANS-AIS. Requires the DWRAP and FEC disabled on the network/OCH ports.
	OC3, OC12, OC48	DWDM-LINE DWDM-SECTION DWDM-TRANS-AIS
TXP_MR_10E	OC192	DWDM-LINE DWDM-SECTION DWDM-TRANS-AIS DWDM-TRANS-SSQUELCH
	10GIGE, 10GFC	DWDM-TRANS-AIS DWDM-TRANS-SQUELCH With REGEN group: DWDM-TRANS-AIS DWDM-TRANS-SQUELCH

**Table 2-19 Payload/Card Mode Support (continued)**

Card Type	Payload	Card Mode
MXP_2.5G_10E	OC48	DWDM-SECTION DWDM-TRANS-AIS DWDM-TRANS-SQUELCH
MXP_MR_2.5G and MXPP_MR_2.5G	Port-1: 1GFC, 1GFICON, GIGE  Port-2: 1GFC, 2GFC, 1GFICON, 2GFICON, GIGE <sup>1</sup>	FCGE <sup>2</sup>

1. If 2GFC or 2GFICON is on Port-2, then Port-1 must be unprovisioned. If Port-1 is provisioned, then Port-2 cannot contain 2GFC or 2GFICON because of bandwidth limitations. Ports 3 through 8 are not available. ESCON payload is not supported.
2. ESCON and mixed card modes are not supported.

The configuration parameters for OCn ports can be retrieved/edited using the ED-<OCN\_TYPE> and RTRV-<OCN\_TYPE> commands. The following is a list of restrictions when using the ED-<OCN\_TYPE> and RTRV-<OCN\_TYPE> commands:

- DCC parameters are used to enable and disable SDCC functionality.
- Line DCC (LDCC) parameters are used to enable and disable LDCC functionality.
- Synchronization parameters are applicable only to cards supporting synchronization: MXP-2.5G-10G, TXP-MR-10E, and MXP-2.5G-10E. Only SYNMSG and SENDDUS parameters are supported.
- Signal fail can be provisioned using the SFBER parameter.
- Signal degrade can be provisioned using the SDBER parameter.
- Soak time and administrative/service state parameters can be provisioned using SOAK, SOAKLEFT, PST, SST, and CMDMDE parameters.
- The SONET/SDH selection can be provisioned using the MODE parameter.
- The name of the facility can be provisioned using the NAME parameter.
- The J0 section parameters can be provisioned using the EXPTRC, TRC, INCTRC, TRCMODE, and TRCFORMAT parameters.

## 2.12.4 Termination Mode Provisioning Rules

Use the following rules when provisioning the termination mode:

- This is a card-level operation.
- Termination mode is only applicable to the OC-3, OC-12, OC-48, and OC-192 payload types.
- Changing termination mode requires the following:
  - All ports must be in the Out of Service (OOS) state because this change is traffic-affecting.
  - All ports must not have DCC terminations (GCC is not applicable).
  - The Section Trace Mode on all ports must be OFF.
  - The trunk port must not be part of any timing source.
  - If any port is Y-cable protected, these rules also apply to the peer slot.

- Section and Line termination modes are supported for the OC-3, OC-12, OC-48, and OC-192 payloads.
- You cannot change the termination mode if the port is part of a Y-cable protection or regeneration group.
- Termination mode provisioning does not apply to the MXP\_MR\_2.5G and MXPP\_MR\_2.5G cards.

To set the termination mode, use the following commands:

- ENT-EQPT
- ED-EQPT

[Example 2-32](#) sets the termination mode of the card in Slot 1 to DWDM-LINE.

**Example 2-32 Set the Termination Mode**

```
ED-EQPT::SLOT-1:116:::CARDMODE=DWDM-LINE;
```

## 2.12.5 Wavelength Provisioning Rules

Use the following rules when provisioning the wavelength:

- Changing the trunk wavelength requires that all trunk ports must be in the OOS state, because this change is service-affecting.
- Setting the wavelength to the first tunable wavelength will cause the first wavelength from the card manufacturing data to be used as the operational wavelength.
- If the provisioned wavelength is set to the first tunable wavelength, any removal of an operational card and subsequent replacement with a card for a different wavelength will not cause a mismatch alarm to be raised.
- To receive the mismatch alarm notification, you need to explicitly provision the wavelength and not use the first tunable wavelength.

Use the ENT-EQPT and ED-EQPT commands to set the card-level wavelength. The following example sets the wavelength of the card in Slot 1 to 1530.33:

```
ED-EQPT:VA454-22:SLOT-1:116:::PWL=1530.33;
```

## 2.12.6 Regeneration Group Provisioning Rules

Use the following rules when provisioning the regeneration group:

- Both the TXPP and TXP versions of the transponder card can be used in a regeneration group.
- When the TXPP card is used as a regeneration group, the LOCKOUT\_OF\_PROTECTION, inhibit switching command will be issued on the working trunk port.
- You cannot unlock the inhibit switching command until the regeneration group is unprovisioned for the TXPP.
- Regeneration group provisioning will be denied if there is a FORCE or MANUAL switching command already provisioned on the trunk ports for the TXPP.
- A regeneration group enables the continuation of the client signal across multiple spans.
- The peer-slot must not be itself.

- The peer-slot must be provisioned or preprovisioned.
- The peer-slot must not be part of another regeneration group.
- The peer-slot must not be part of a Y-cable protection group.
- Both cards must have the same card type.
- Both cards must have the same payload type and data rate.
- Both cards must have the same ITU-T G.709 OTN status.
- Both cards must have the same FEC status.
- Termination mode must be set to TRANSPARENT (AIS or SQUELCH) mode.

Use the ED-EQPT and ENT-EQPT commands to set a card-level regeneration group. The following command sets a card-level regeneration group for Slot 2.

```
ED-EQPT::SLOT-2:CTAG:::PROTID=SLOT-2,NAME=REGENGROUPNAME;
```

## 2.12.7 DCC/GCC Provisioning Rules

Use the following rules when provisioning DCC and GCC:

- The DCC can be provisioned on the client port of a TXP or MXP card.
- 2R payload types do not support GCC.
- To provision a DCC, the payload data type must be set to OC-3, OC-12, OC-48, or OC-192.
- To provision a DCC, the termination mode must be set to Line or Section terminated (if the card supports provisionable termination mode).
- The DCC can be provisioned on the trunk line provided that ITU-T G.709 is provisionable and the ITU-T G.709 OTN status is turned off:
  - To provision a GCC on the trunk port, ITU-T G.709 should be enabled.
  - To provision a DCC on the trunk port, ITU-T G.709 should be disabled.
- Only the working client port in a Y-cable protection scheme can be provisioned with DCC.
- Only the working trunk port in a splitter protection scheme can be provisioned with DCC or GCC.

Use the ED-(OCn, nGIGE, NGFC) command to provision DCC, as shown in the following command:

```
ED-OC192::FAC-1-1-1:100:::COMM=DCC:OOS,AINS;
```

Use the ED-OCH command to provision GCC, as shown in the following command:

```
ED-OCH::CHAN-6-2:114:::COMM=GCC:OOS,AINS;
```

## 2.12.8 ITU-T G.709 OTN, FEC, and OTN SDBER/SFBER Provisioning Rules

Use the following rules when provisioning ITU-T G.709 OTN, FEC, and OTN SDBER/SFBER:

- The ITU-T G.709 OTN, FEC, and OTN SDBER/SFBER can only be provisioned on the trunk port.
- 2R (transparent) payload types (HDTV, passthrough) do not support ITU-T G.709 OTN or FEC.
- To enable ITU-T G.709 OTN:
  - All trunk ports must be in the OOS state.
  - All trunk ports must not have any SDCC provisioned.

- To disable ITU-T G.709 OTN:
  - All trunk ports must be in the OOS state.
  - All trunk ports must not have any GCC or active trail trace identification (TTI) mode provisioned.
- FEC status can be enabled only if ITU-T G.709 is enabled.
- To change FEC status, all trunk ports must be in the OOS state.
- Only ITU-T G.709 OTN, FEC status, and the SDBER/SFBER setting on the working trunk port can be changed in the protected version of the TXP. The value provisioned on the working trunk port will be reflected on the protect trunk port.
- The ITU-T G.709 OTN is only provisionable in non-2R (or unframed) payload type.
- When ITU-T G.709 is turned on, the OTN SFBER value is always set to 1E-5 and no other BER values are provisionable.

Use the ED-OCH commands to provision ITU-T G.709, FEC, and OTN SDBER/SFBER, as shown in the following example:

```
ED-OCH::CHAN-6-2:114:::OSDBER=1E-6,DWRAP=Y,FEC=Y,:OOS,AINS;
```

## 2.12.9 Synchronization Provisioning Rules

Use the following rules when provisioning synchronization:

- The TXP\_MR\_10G, TXP\_MR\_2.5G, and TXPP\_MR\_2.5G are through-timed (passthrough) and cannot be used as a timing source.
- The TXP\_MR\_10E can be used as a timing reference (only the client port, not the trunk port).
- A MXP\_MR\_2.5G or MXPP\_MR\_2.5G card trunk port can be used as a timing source.
- Only MXP ports can be used for a timing source. A trunk port is only allowed as a timing reference if ITU-T G.709 is off and the termination mode is Line or Section.
- For MXP cards, all client ports are available for timing source irrespective of termination mode.

Use the ENT-OCn, ED-OCn, and ED-OCH commands to set port-level synchronization attributes, as shown in the following examples:

```
ED-OC48::FAC-1-1-1:CTAG:::SYNCMSG=Y,SENDDUS=N::;
```

```
ED-OCH::CHAN-6-2:114:::SYNCMSG=N,SENDDUS=Y::;
```

## 2.12.10 Section Trace Provisioning (J0) Rules

Use the following rules when provisioning section trace (J0):

- The client and trunk ports only support section trace if the payload is OC-3, OC-12, OC-48, or OC-192.
- The client and the trunk ports support section trace only in Line or Section terminated mode.
- In Line termination mode, the supported trace modes are MANUAL and MANUAL\_NO\_AIS.
- In Section termination mode, only the MANUAL\_NO\_AIS trace mode is supported.
- The section trace supports 1-byte or 16-byte length trace format.
- The AUTO and AUTO-NO-AIS trace modes are not supported.

- No trace mode is applicable for 2R (unframed) payload types, for example, DV-6000, HDTV, and ESCON.
- The section trace received string should appear when the card is in TRANSPARENT-AIS or TRANSPARENT-SQUELCH termination mode and the payload is OC-3, OC-12, OC-48, or OC-192.
- When the client port is configured in a Y-cable protection group, the received string is always retrieved from the active client port.
- If the line is Y-cable protected, trace can only be provisioned on the working port. However, the provisioning will be duplicated between the two ports, that is, both ports will contain the same values. This rule applies to the following parameters: Mode, Format, Send String, and Expected String.
- The MXP\_2.5G\_10E card is used for client test connection on client ports. For the trunk port, the TTI is used.
- The TXP\_MR\_10E card is used to test connections on client trunk ports.
- On MXP\_MR\_2.5G/MXPP\_MR\_2.5G cards, the trunk port section trace can be provisioned following the rules for line-terminated SONET equipment.

Use the ED-OCn command for trace provisioning of client ports provisioned for OCn payload, as shown in the following example:

```
ED-OC48::FAC-6-1-1:10::EXPTRC="AAA",TRC="AAA",TRCMODE=MAN,TRCFORMAT=16-BYTE;
```

Use the ED-TRC-OCH command for trace provisioning of trunk/OCH DWDM ports, as shown in the following example:

```
ED-TRC-OCH::CHAN-6-2:10::EXPTRC="AAA",TRC="AAA",TRCMODE=MAN,TRCLEVEL-J0,TRCFORMAT=64-BYTE;
```

## 2.12.11 Trail Trace Identification Provisioning Rules

Use the following rules when provisioning trail trace identification (TTI):

- For the TXPP\_MR\_2.5G card, TTI can be provisioned on the working trunk port only. However, the provisioning will be duplicated between the two ports. Both ports will contain the same values. This rule applies to the following parameters: Mode, Format, Send String, and Expected String.
- The TTI level trace supports only the 64-byte length trace format.
- The TTI level trace supports only the MANUAL and MANUAL\_NO\_AIS trace modes.
- The TTI received string is always retrieved from the active trunk port.
- The TTI level trace can be provisioned for Section and Path monitoring.
- MXP\_MR\_2.5G and MXPP\_MR\_2.5G cards do not support TTI.

Use the ED-TRC-OCH command to provision port-level trace, as shown in the following example:

```
ED-TRC-OCH::CHAN-6-2:10::EXPTRC="AAA",TRC="AAA",TRCMODE=MAN,TRCLEVEL=TTI-PM,TRCFORMAT=64-BYTE;
```

## 2.12.12 PM and Alarm Threshold Provisioning Rules

Use the following rules when provisioning PM parameters and alarm thresholds:

- When the framing type is unframed, for example, HDTV and DV6000, only optics threshold provisioning and PM are applicable. Support for optics threshold provisioning and PM depends on the ESCON SFP type.
- Optics PM supports only Near End, 15MIN, and 1DAY interval buckets.
- When the framing type is Fibre Channel or Ethernet (for example, 1GFC, 1G Ethernet):
  - (TXP\_MR\_2.5G/TXPP\_MR\_2.5G, MXP\_2.5G\_10G, and TXP\_MR\_10G cards only) Only 8B10B threshold provisioning and PM are available.
  - 2G Fibre Channel does not support 8B10B threshold provisioning and PM.
- (TXP\_MR\_2.5G/TXPP\_MR\_2.5G, MXP\_2.5G\_10G, and TXP\_MR\_10G cards only) 8B10B applies to both transmit (Tx) and receive (Rx) directions.
- 8B10B PM supports only Near End, 15MIN, and 1DAY interval buckets.
- The 8B10B layer is not used for MXP\_2.5G\_10E and TXP\_MR\_10E cards.
- When the framing type is SONET/SDH, all monitored PM parameter terminology follows the current chassis type.
- The OTN thresholds are only applicable if ITU-T G.709 OTN is enabled.
- The FEC thresholds are only applicable if ITU-T G.709 and FEC are enabled.
- If the line is configured in a Y-cable or splitter protection group, only the working line thresholds can be provisioned. The working line thresholds will be reflected on the protect line thresholds. This rule applies for all threshold types including ITU-T G.709 OTN and FEC thresholds.
- Payload PM can be independently retrieved for the working and protect ports.

Use the SET-TH-(OCn, nGIGE, nGFC, OCH) command to set port-level thresholds, for example:

```
SET-TH-OC48::FAC-1-1-1:123::CVL,12,NEND,,15-MIN;
```

```
SET-TH-OCH::CHAN-6-1:123::ES-PM,12,NEND,,15-MIN;
```

Use the RTRV-PM-(OCn, nGIGE, nGFC, OCH) command to retrieve port-level thresholds, for example:

```
RTRV-PM-OC48::FAC-1-1-1:123::CVL,10-UP,NEND,BTH,15-MIN,04-11,12-45;
```

```
RTRV-PM-OCH::CHAN-6-1:123::ES-PM,10-UP,NEND, BTH,15-MIN,04-11,12-45;
```

## 2.12.13 Y-Cable Protection Group Provisioning Rules

Use the following rules when provisioning a Y-cable protection group:

- A Y-cable protection group can be created between the client ports of two unprotected TXPs only.
- While in Y-cable protection, a TXP cannot be part of a regeneration group.
- Only the working client port can be provisioned with SDCC.
- Y-cable cannot be provisioned for a protect version of the TXP\_MR\_2.5G card.
- Only the working ports (not the protect) can be provisioned with DCC and timing reference.

Use the ENT-FFP-(OCn, nGIGE, nGFC), DLT-FFP-(OCn, nGIGE, nGFC), and ED-FFP-(OCn, nGIGE, nGFC) commands to provision Y-cable protection groups, as shown in the following examples:

```
ENT-FFP-OC48::FAC-1-1-1,FAC-2-1-1:100::PROTOTYPE=Y-CABLE,
PROTID=DC-METRO-1,RVRTV=Y,RVTM=1.0,PSDIRN=BI;
```

```
ENT-FFP-10GIGE::FAC-1-1-1,FAC-2-1-1:100::PROTOTYPE=Y-CABLE,
PROTID=DC-METRO-2,RVRTV=Y,RVTM=1.0,PSDIRN=BI;
```

## 2.12.14 Splitter Protection Group Provisioning Rules

Use the following rules when provisioning a splitter protection group:



### Note

Splitter protection group provisioning rules apply only to the protect version of the TXP card.

- Splitter protection groups cannot be created or deleted.
- A splitter protection group is created automatically when a protect TXP card is provisioned.
- The only editable attributes are: Revertive, Revertivetime, and Transponder mode.

The TL1 command to provision a splitter protection group ([Example 2-33](#)) is:

- ED-FFP-OCH

### **Example 2-33 Provisioning Splitter Protection Group Attributes:**

```
ED-FFP-OCH::CHAN-2-1:100::PROTID=DC-METRO3,RVRTV=Y,
RVTM=5.0,PSDIRN=BI;
```

## 2.12.15 Loopback Provisioning Rules

Use the following rules when provisioning loopbacks:

- Loopbacks can be provisioned on the client and trunk ports.
- Both terminal and facility loopback types can be provisioned.
- Loopback is not applicable when the framing type is UNFRAMED (HDTV, DV6000).
- For the protect TXP, the following loopback rules apply to the trunk ports:
  - Only one loopback can be provisioned at the trunk ports at any given time.
  - Loopback is allowed only if the sibling trunk port is OOS-MT.
  - Provisioning a loopback on a trunk port will trigger the inhibit switching command LOCKOUT\_OF\_PROTECTION or LOCKOUT\_OF\_WORKING, depending on whether the working or the protect is placed in a loopback.
  - When a loopback is provisioned on a trunk port, both of the trunk ports will transmit the signal of the loopback port signal.
  - A loopback will be denied if there is a FORCE or MANUAL switching command in place on the trunk ports.

- You cannot remove the inhibit switching command issued as a result of the loopback. This command will be removed only when the loopback is removed.

The TL1 command is OPR-LPBK-OCH.

Example of operating a loopback:

```
OPR-LPBK-OCH::CHAN-2-1:1::,,TERMINAL;
```

## 2.12.16 Automatic Laser Shutdown Provisioning Rules

Use the following rules when provisioning automatic laser shutdown (ALS):

- ALS can be provisioned on the client and trunk ports.
- If the trunk port is configured in a splitter protection group, only the working trunk port can be provisioned for ALS. However, provisioning on the working trunk port is reflected on the protect port.
- For the protected TXP, ALS mode will only take effect when both ports receive a loss of signal (LOS).

Use the ED-ALS and ED-ALS-(OCn, nGIGE, nGFC, OTS, OMS, OCH) commands to provision ALS, as shown in the following examples:

```
ED-ALS::FAC-1-1-1:100:::ALSMODE=Y,ALSRCINT=130,ALSRCPW=35.1,RLASER=Y;
```

```
ED-ALS-OC192::FAC-1-1-1:100:::ALSMODE=Y,ALSRCINT=130,ALSRCPW=35.1,
RLASER=Y;
```

## 2.12.17 Port State Model Provisioning Rules

Use the following rules when provisioning the port state model:

- The Out of Service, Automatic In-Service (OOS,AINS) port service state is not supported for the 1GigE and 2GigE payload types.
- The working and protect ports can be put in the IS and OOS states independently.
- For the protect TXP card:
  - Setting the protect trunk port to OOS enables the suppression of alarms on that port and will enable the card to be used like an unprotected card, but the card still cannot be used for a Y-cable protection group.
  - Setting the protect trunk port to OOS will not switch off the transmit laser unless both trunk ports are OOS.
  - The protect trunk port cannot be IS if a loopback or a regeneration group is provisioned.

Use the ED-(OCn, nGIGE, nGFC, OCH) command to edit the port state, as shown in the following examples:

```
ED-OC48::FAC-6-1-1:114:::OOS,AINS;
```

```
ED-10GIGE::FAC-6-1:114:::OOS,AINS;
```

```
ED-OCH::CHAN-6-1:114:::IS;
```

## 2.12.18 SONET-Related Provisioning Rules

When provisioning SONET-related parameters, the SDBER and SFBER can only be provisioned on the working trunk port (OCH) for the protect TXP card. Values set at the working port will be reflected on the trunk port.

Use the ED-OCH command to edit SONET trunk port attributes, as shown in the following example:

```
ED-OCH::CHAN-6-2:114::RDIRN=W-E,EXPWLEN=1530.32,VOAATTN=2.5,VOAPWR=7.5,
CALOPWR=0,CHPOWER=2.0,NAME="NYLINE",SFBER=1E-5,SDBER=1E-6,
ALSMODE=MAN,ALSRCINT=60,ALSRCPW=35.1,COMM=DCC,GCCRATE=192K,
OSDBER=1E-6,DWRAP=Y,FEC=Y,MACADDR=OO-OE-AA-BB-CC-DD,SYNCMSG=N,
SENDDUS=Y,RLASER=Y,SOAK=10,OSPF=Y:OOS,AINS;
```

## 2.12.19 Overhead Circuit Provisioning Rules

1. LOW/EOW is possible between the AIC-I, OCn and TXP/TXPP cards in any combination in line-terminated mode.
2. F1/D4-D12 UDC:
  - a. Not possible between TXP/TXPP and AIC-I cards in line-terminated mode.
  - b. Not possible between TXP/TXPP and OCn cards in line-terminated mode.
  - c. Possible between OC-N ports.
3. All OH bytes are passed across client and DWDM ports in transparent mode.
4. SDCC/LDCC tunneling is not possible in line-terminated mode.
5. No end-to-end OH circuit provisioning.
6. For MXP\_MR\_2.5G and MXPP\_MR\_2.5G cards these rules apply to the trunk port only.

## 2.12.20 Hardware Limitation Rules

The DWDM cards have the following hardware limitations:

- The ESCON Small Form-factor Pluggable (SFP) does not support any monitoring.
- Optics thresholds and PM are not shown on client ports.
- HI/LO-TXPOWER is not supported for TXP\_MR\_2.5G and TXPP\_MR\_2.5G cards.

