



Configuring the Cisco PAD Facility for X.25 Connections

This chapter describes how to use the internal packet assembler/disassembler (PAD) facility to make connections with remote devices over the X.25 protocol. This chapter includes the following sections:

- [PAD Connection Overview](#)
- [X.3 PAD EXEC User Interface Configuration Task List](#)
- [X.28 PAD Emulation Configuration Task List](#)
- [Making X.25 PAD Calls over IP Networks](#)
- [Configuring PAD Subaddressing](#)
- [Configuring X.29 Reselect](#)
- [Using Mnemonic Addressing](#)
- [PAD Examples](#)

Table 1 in this chapter summarizes the X.3 PAD parameters that you can set. For a complete description of each X.3 parameter supported by the standard X.28 mode or Cisco PAD EXEC user interface, see the appendix “X.3 PAD Parameters” at the end of this publication.

For a complete description of the commands in this chapter, refer to the *Cisco IOS Terminal Services Command Reference*, Release 12.2. To locate documentation of other commands that appear in this chapter, use the command reference master index or search online.

To identify the hardware platform or software image information associated with a feature, use the Feature Navigator on Cisco.com to search for information about the feature or refer to the software release notes for a specific release. For more information, see the “Identifying Supported Platforms” section in the “Using Cisco IOS Software” chapter.

PAD Connection Overview

PADs are configured to enable X.25 connections between network devices. A PAD is a device that receives a character stream from one or more terminals, assembles the character stream into packets, and sends the data packets out to a host. A PAD can also do the reverse. It can take data packets from a network host and translate them into a character stream that can be understood by the terminals. A PAD



is defined by Recommendations X.3, X.28, and X.29 of the International Telecommunication Union Telecommunication Standardization Sector (ITU-T). (The ITU supersedes the Consultative Committee for International Telegraph and Telephone, or CCITT).

Figure 1 shows a remote X.25 user placing a call through an X.25 switched network to the internal PAD application on a Cisco 4700-M router, and to an X.25 host located inside a corporate data center.

Figure 1 Standard X.25 Connection Between a Dumb Terminal and an X.25 Host

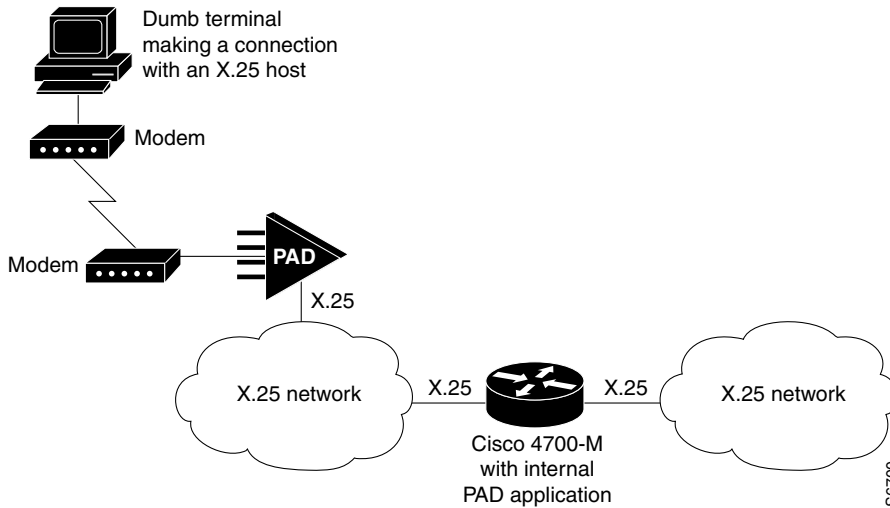

PADs can also be configured to work with a protocol translation application. Figure 2 shows an example of a remote PC placing an analog modem call to an IP network, connecting to a Cisco 4500-M router, and allowing its IP packets to undergo IP-to-X.25 protocol translation. The remote PC, in turn, communicates with an internal PAD device in the Cisco router and establishes a connection with an X.25 host.

Figure 2 PC Dialing In to an X.25 Host Using Protocol Translation

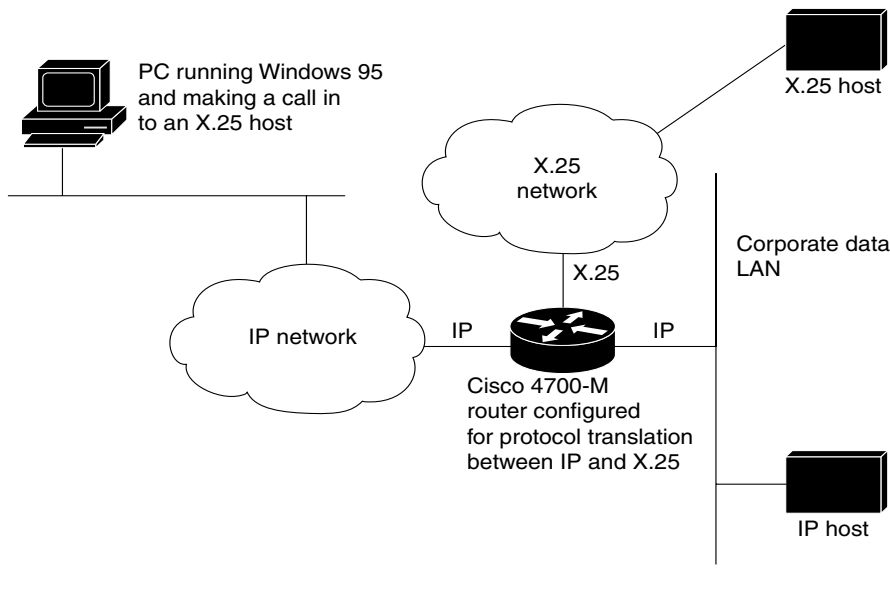

Cisco IOS offers two ways of connecting to a PAD: using the **pad** EXEC user interface command to initiate an outgoing connection to a PAD, and using the **x28** EXEC command to access the Cisco universal X.28 PAD user emulation mode.

In X.28 PAD user emulation mode, you can perform the same functions available from the Cisco **pad** EXEC user interface; however, X.28 PAD user emulation mode adds functionality such as the ability to exchange PAD signals across an X.25 network, and is useful for connecting to systems using software designed to interact with an X.28 PAD. X.28 PAD user emulation mode is also useful when a reverse connection requires packetization according to the X.29 parameters.

Cisco PAD EXEC User Interface Connections

The Cisco IOS **pad** EXEC user interface initiates an outgoing call to a PAD host and in most cases is the preferred PAD connection method. You can have multiple PAD connections open at one time. Options are available for pausing and resuming connections, and setting X.3 PAD parameters at the command line.

Cisco Universal X.28 PAD Emulation Mode

The Cisco IOS software provides a universal X.28 user emulation mode that enables you to interact with and control the PAD. X.28 emulation effectively turns the Cisco router into an X.28-compliant PAD device that provides a standard user interface between a DTE device and a PAD.

For asynchronous devices such as terminals or modems to access an X.25 network host, the packets from the device must be assembled or disassembled by a PAD. Using standard X.28 commands from the PAD, calls can be made into an X.25 network, X.3 PAD parameters can be set, or calls can be reset.

X.3 is the ITU-T recommendation that defines various PAD parameters used in X.25 networks. X.3 PAD parameters are internal variables that define the operation of a PAD. For example, parameter 9 is the *crpad* parameter. It determines the number of bytes to add after a carriage return. X.3 parameters can also be set by a remote X.25 host using X.29. (See [Figure 3](#).)

Figure 3 Asynchronous Device Dialing In to an X.25 Host over an X.25 Network

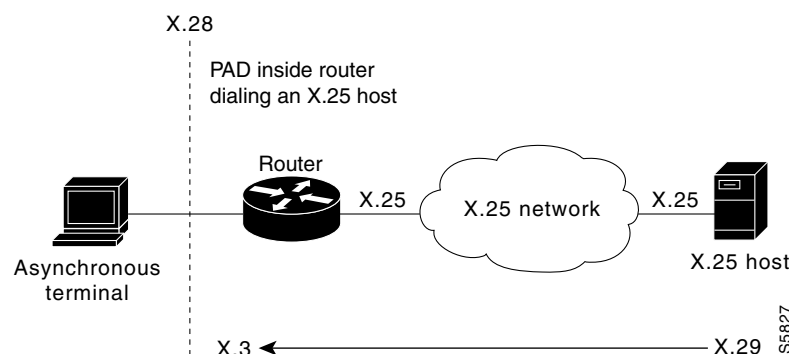

Note

Most Cisco routers have internal PAD devices. Use the Feature Navigator on Cisco.com to determine which software supports PAD connections.

X.28 enables PAD system administrators to dial in to X.25 networks or set PAD parameters using the X.28 standard user interface. This standard interface is commonly used in many European countries. It adheres to the X.25 ITU-T standards.

The X.28 interface is designed for asynchronous devices that require X.25 transport to access a remote or native asynchronous or synchronous host application. For example, dialup applications can use the X.28 interface to access a remote X.25 host. X.28 PAD calls are often used by banks to support applications in the “back office” such as ATM machines, point of sales authorization devices, and alarm systems. An ATM machine may have an asynchronous connection to an alarm host and a Cisco router. When the alarm is tripped, the alarm sends a distress call to the authorities via the Cisco router and an X.28 PAD call.

Cisco X.28 PAD calls can be transported over a public packet network, a private X.25 network, the Internet, a private IP-based network, or a Frame Relay network. X.28 PAD can also be used with protocol translation. Protocol translation and virtual asynchronous interfaces enable users to bidirectionally access an X.25 application with the PAD service or other protocols such as Digital, local-area transport (LAT), and TCP.

X.3 PAD EXEC User Interface Configuration Task List

To connect to a PAD using the EXEC user interface, perform the following tasks:

- [Making a PAD Connection](#) (Required)
- [Switching Between Connections](#) (Optional)
- [Exiting a PAD Session](#) (Optional)
- [Monitoring X.25 PAD Connections](#) (Optional)
- [Setting X.3 PAD Parameters](#)(Optional)

Making a PAD Connection

To log in to a PAD, use the following command in EXEC mode:

Command	Purpose
Router> pad { <i>x121-address</i> <i>hostname</i> } [/ cmd <i>text</i>] [/ debug] [/ profile <i>name</i>] [/ quiet <i>message</i>] [/ reverse] [/ use-map]	Logs in to a PAD.

You can exit a connection and return to the user EXEC prompt at any point.

To open a new connection, first exit the current connection by entering the escape sequence (Ctrl-Shift-6 then x [Ctrl^x] by default) to return to the EXEC prompt.

Switching Between Connections

You can have several concurrent sessions open and switch between them. The number of sessions that can be open is defined by the **session-limit** command, which is described in the [Cisco IOS Terminal Services Command Reference](#), Release 12.2.

To switch between sessions by escaping one session and resuming a previously opened session, use the following commands in EXEC mode:

	Command	Purpose
Step 1	Router> Ctrl-Shift-6 then x (Ctrl^x) by default	Escapes the current connection, if you have one open, and returns to EXEC mode.
Step 2	Router> where	From EXEC mode, lists the open sessions. All open sessions associated with the current terminal line are displayed.
Step 3	Router> resume [<i>connection</i>] [<i>keyword</i>]	Makes the connection using the session number displayed by the where command.

**Note**

The **Ctrl^x**, **where**, and **resume** commands are available with all supported connection protocols.

Exiting a PAD Session

To exit a PAD session, enter the escape sequence (Ctrl-Shift-6 then x [Ctrl^x] by default) and enter the **disconnect** command at the EXEC prompt. You can also log out of the remote system by entering the command specific to that system (such as **exit**, **logout**, **quit**, **close**, or **disconnect**).

Monitoring X.25 PAD Connections

To display information about current open connections, use the following command in user EXEC mode:

Command	Purpose
Router> show x25 pad	Displays information about X.25 PAD connections that are open.

The information displayed by **show x25 pad** includes packet transmissions, X.3 parameter settings, and the current status of virtual circuits. The information displayed will help you set and change PAD parameters (see the section “[X.3 Parameter Customization Example](#)” for an example).

Setting X.3 PAD Parameters

To set X.3 PAD parameters, use one of the following commands in EXEC mode:

Command	Purpose
Router> resume [<i>connection</i>] [/set <i>parameter:value</i>] or Router> x3 <i>parameter:value</i>	Sets X.3 PAD parameters.

Table 1 summarizes the X.3 PAD Parameters supported on Cisco devices. See the “X.3 PAD Parameters” appendix in this publication for more complete information about these parameters. Refer to the “ASCII Character Set and Hex Values” appendix in the *Cisco IOS Configuration Fundamentals Command Reference*, Release 12.2, for a list of ASCII characters.

Table 1 Supported X.3 PAD Parameters





Parameter Number	ITU-T Parameter Name	ITU-T X.3 and Cisco Values
1	PAD recall using a character	Minimum value: 0; maximum value: 126; X.28 PAD user emulation mode default: 1.  Note Not supported by PAD EXEC user interface.
2	Echo	Minimum value: 0; maximum value: 1; PAD EXEC mode and X.28 PAD user emulation mode default: 1.
3	Selection of data forwarding character	Minimum value: 0; maximum value: 255; PAD EXEC mode default: 2 (CR); X.28 PAD user emulation mode default: 126 (~).
4	Selection of idle timer delay	Minimum value: 0; maximum value: 255; PAD EXEC mode default: 1; X.28 PAD user emulation mode default: 0.
5	Ancillary device control	Minimum value: 0; maximum value: 2; PAD EXEC mode default: 0; X.28 PAD user emulation mode default: 1.
6	Control of PAD service signals	Minimum value: 0; maximum value: 255; PAD EXEC mode default: 0; X.28 PAD user emulation mode default: 2.  Note Not supported by PAD EXEC user interface.
7	Action upon receipt of a BREAK signal	Minimum value: 0; maximum value: 31; PAD EXEC mode default: 4; X.28 PAD user emulation mode default: 2.
8	Discard output	Minimum value: 0; maximum value: 1; PAD EXEC mode and X.28 PAD user emulation mode default: 0.
9	Padding after Return	Minimum value: 0; maximum value: 255; PAD EXEC mode and X.28 PAD user emulation mode default: 0.
10	Line folding	Not supported.
11	DTE speed (binary speed of start-stop mode DTE)	Minimum value: 0; maximum value: 18; PAD EXEC mode and X.28 PAD user emulation mode default: 14.
12	Flow control of the PAD by the start-stop DTE	Minimum value: 0; maximum value: 1; PAD EXEC mode default: 0; X.28 PAD user emulation mode default: 1.
13	Line feed insertion (after a Return)	Minimum value: 0; maximum value: 7; PAD EXEC mode and X.28 PAD user emulation mode default: 0.
14	Line feed padding	Minimum value: 0; maximum value: 255; PAD EXEC mode and X.28 PAD user emulation mode default: 0.
15	Editing	Minimum value: 0; maximum value: 1; PAD EXEC mode and X.28 PAD user emulation mode default: 0.

Table 1 Supported X.3 PAD Parameters (continued)

Parameter Number	ITU-T Parameter Name	ITU-T X.3 and Cisco Values
16	Character delete	Minimum value: 0; maximum value: 127; PAD EXEC mode and X.28 PAD user emulation mode default: 127 (DEL).
17	Line delete	Minimum value: 0; maximum value: 127; PAD EXEC mode default: 21 (NAK or Ctrl-U); X.28 PAD user emulation mode default: 24 (CAN or Ctrl-X).
18	Line display	Minimum value: 0; maximum value: 127; PAD EXEC mode and X.28 PAD user emulation mode default: 18 (DC2 or Ctrl-R).
19	Editing PAD service signals	Minimum value: 0; maximum value: 126; PAD EXEC mode default: 0; X.28 PAD user emulation mode default: 2.  Note Not supported by PAD EXEC user interface.
20	Echo mask	Minimum value: 0; maximum value: 255; PAD EXEC mode and X.28 PAD user emulation mode default: 0.  Note Not supported by PAD EXEC user interface.
21	Parity treatment	Minimum value: 0; maximum value: 4; PAD EXEC mode and X.28 PAD user emulation mode default: 0.  Note For additional values that can be selected for parameter 21, see Table 23 in this guide. To select parity treatment to conform to the French Transpac public switched data network and its technical specification and utilization of networks standards (STUR), see Table 24 in this guide.
22	Page wait	Not supported.

X.28 PAD Emulation Configuration Task List

To use the X.28 PAD mode, perform the following tasks as needed:

- [Accessing X.28 Mode and Setting Options](#) (Required)
- [Exchanging PAD Command Signals](#) (Optional)
- [Customizing X.3 Parameters](#) (Optional)
- [Accepting Reverse or Bidirectional X.25 Connections](#) (Optional)
- [Setting PAD French Language Service Signals](#) (Optional)

The section “[Cisco Universal X.28 PAD Emulation Mode Examples](#)” provides examples of making X.28 PAD connections.

Accessing X.28 Mode and Setting Options

To access the Cisco IOS universal X.28 emulation mode, use the **x28 EXEC** command. This mode can also be accessed with the **autocommand** line configuration command. The **autocommand** command can be assigned to a particular line, range of lines, or login user ID. In this case, when a user connects to the line, the user sees an X.28 interface. Using the **noescape** option with the autocommand feature blocks users from getting into EXEC mode.

The default X.28 router prompt is an asterisk (*). After you see *, the standard X.28 user interface is available. You configure the PAD in this mode.

To enter X.28 mode and set different access and display parameters, use the following commands in EXEC mode:

Command	Purpose
Router> x28 escape <i>character-string</i>	Specifies a character string to use to exit X.28 mode and return to EXEC mode. This string becomes an added command to X.28 mode that, when entered by the user, terminates X.28 mode and returns to EXEC mode. The default escape string is exit . ¹
Router> x28 nuicud	Places the data entered in the network user identification (NUI) facility by the user into the Call User Data (CUD) field of the X.25 call request packet. ²
Router> x28 profile <i>file-name</i>	Specifies a user-defined X.3 profile. If this option is specified, with a profile name, then the profile is used as the initial set of X.3 parameters. ³
Router> x28 reverse	Reverses the charges of all calls dialed by the local router. The address of the destination device is charged for the call. This is the default configuration. Every call is placed with the reverse charge request set.
Router> x28 verbose	Displays detailed information about the X.25 call connection (for example, address of the remote DTE device and the facility block used).

1. If the **x28 noescape** command is set, then it is impossible to return to the EXEC mode from X.28 mode. Use with caution. This command is not accepted when using the console line.
2. Upon entry of the **x28 nuicud** command, the network user (NU) data will not be placed in the NUI facility of the call request. Instead it will be placed in the CUD field. If you configure the **x28 nuicud** command, all reverse charging requests set by the **x28 reverse** command are disabled.
3. Profiles are created with the **x29 profile** EXEC command. If the X.29 profile is set to **default**, the profile is applied to all incoming X.25 PAD calls, including the calls used for protocol translation.



See the section [“PAD Mode Connection Examples”](#) for examples of how the **x28** and **pad** commands work.

Exchanging PAD Command Signals

The Cisco IOS universal X.28 emulation mode allows you to interact with and control the PAD. During an exchange of control information, messages or commands sent from the terminal to the PAD are called PAD command signals. Messages sent from the PAD to the terminal are called PAD service signals.

Many X.25-related functions can be performed in X.28 mode by exchanging PAD signals, such as placing and clearing calls. [Table 2](#) lists the PAD X.28 command signals supported in the Cisco universal X.28 emulation mode.

Table 2 Available PAD Command Signals

Command	Extended Command	Purpose
break	—	Simulates an asynchronous break.
call	—	Places a virtual call to a remote device.
command-signal	—	Specifies a call request without using a standard X.28 command, which is entered with the following syntax: <i>facilities-x121-addressDcall-user-data</i> . The hyphen (-) and “D” are required keywords.
clr	clear	Clears a virtual call.
help	—	Displays help information.
iclr	iclear	Requests the remote device to clear the call.
int	interrupt	Sends an Interrupt packet.
par? par	parameter read	Displays the current values of local parameters.
prof	profile <i>file-name</i>	Loads a standard or named profile.
reset	—	Resets the call.
rpar?	rread	Displays the current values of remote parameters.
rset?	rsetread	Sets and then reads values of remote parameters.
set	—	Changes the values of local parameters. (See the “ Customizing X.3 Parameters ” section later in this chapter.)
set?	setread	Changes and then reads the values of parameters.
stat	status	Requests status of a connection.
selection pad	—	Sets up a virtual call.

**Note**

You can choose to use the standard or extended command syntax. For example, you can enter the **clr** command or **clear** command to clear a call. A command specified with standard command syntax is merely an abbreviated version of the extended syntax version. Both syntaxes function the same.

Placing a Call

To place a call to another X.25 destination, you specify the destination X.121 address optionally preceded by facility requests and optionally followed by CUD. As of Cisco IOS Release 12.0, Cisco only supports the reverse charge and NUI facilities.

To place a call, use the following commands in EXEC mode:

	Command	Purpose
Step 1	Router> x28	Enters X.28 mode. An asterisk prompt appears.
Step 2	* call <i>address</i>	Dials the address of the remote interface.

**Note**

In X.28 mode, you can perform the same functions as those available with the Cisco **pad** EXEC user interface. However, X.28 mode adds functionality such as setting X.3 PAD parameters with industry-standard X.28 commands.

Clearing a Call

To clear a connection after you connect to a remote X.25 device, use the following commands in EXEC mode:

	Command	Purpose
Step 1	* Ctrl-p	From the remote host, escapes back to the local router.
Step 2	Router> clr	Clears the virtual call.

Customizing X.3 Parameters

To set an X.3 PAD parameter from a local terminal, use the following commands in EXEC mode:

	Command	Purpose
Step 1	Router> x28	Enters X.28 mode.
Step 2	* par	Displays the current X.3 PAD parameters.
Step 3	* set <i>parameter-number: new-value</i>	Changes the value of a parameter.
Step 4	* par	Verifies that the new PAD parameter was set correctly.

See [Table 1](#) and the “X.3 PAD Parameters” appendix at the end of this publication for more information.

Accepting Reverse or Bidirectional X.25 Connections

Active lines operating in X.28 mode can receive incoming calls from the network, if they do not already have an active call. The user is notified of the call by the X.28 incoming call service signal. This feature extends the traditional capability of reverse PAD connections, which could only be received on lines that were not active.

The criteria to choose the line the call is intended for are the same as for reverse PAD connections. (The rotary is chosen from the subaddress portion of the destination address.) Because the normal rotary selection mechanism (which checks whether lines have an active EXEC) takes precedence, reverse connections to lines in X.28 mode only will work reliably to rotaries consisting of a single line.

Setting PAD French Language Service Signals

Extended dialog mode for PAD service signals is available in both the French and English languages with the PAD French Enhancement feature. The French language service signals are maintained in a table. When configured for the French language via PAD parameter 6, the PAD service signals map to

this table, giving the appropriate French equivalent output. The internal table maintenance is based on the contents of the Annex-C/X.28 standard. Section 3.5/X.28 outlines parameter 6 and how it relates to extended mode dialog in multiple languages.

The French language service signals are maintained in a table. When set for the French language via PAD parameter 6, the PAD service signals map to the French language service signals and provide the appropriate French equivalent output.

In X.28 Mode

To set French language service signals in X.28 mode, use the following commands beginning in EXEC mode:

	Command	Purpose
Step 1	Router> x28	Enters X.28 mode.
Step 2	* set 6:9	Sets the value of parameter 6 to 9 for French recognition.

Using an X.29 Profile

You can create an X.29 profile script that sets X.3 PAD parameters by using the **x29 profile** command. See the section “Creating an X.29 Profile Script” in the chapter “Configuring Protocol Translation and Virtual Asynchronous Devices” for more information about X.29 profiles.

To set French language service signals using an X.29 profile, use the following command in global configuration mode:

Command	Purpose
Router(config)# x29 profile <i>profilename</i> 6:9	Sets the value of parameter 6 to 9 (on a defined set of X.3 parameters) for French recognition in an X.29 profile.

Verifying PAD French Enhancement

To verify that PAD French enhancement has been configured, enter the **parameter** command in X.28 EXEC mode (for either X.28 or X.29 profiles):

```
* parameter
  PAR 1:1 2:1 3:16 4:0 5:1 6:9 7:2 8:0 9:1 10:0 11:4 12:1 13:0 14:0 15:0 16:12 17:2 18:0
  19:0 20:0 21:0 22:0
```

Remote Access to X.28 Mode

Several ways to access X.28 PAD mode on the router are described in the following sections:

- [Using an Asynchronous Line](#)
- [Using Incoming Telnet](#)
- [Using Incoming X.25](#)

Using an Asynchronous Line

If an asynchronous line is configured with the **autocommand x28** command, the devices connected to the asynchronous line always get X.28 mode. Otherwise, an EXEC session is on the line and the **x28** command can be issued to start X.28 mode.

To set up X.28 mode on the router, perform the following the steps:

-
- Step 1** Enter global configuration mode:

```
Router# configure terminal
Enter configuration commands, one per line. End with CNTL/Z.
```

- Step 2** Bring up a one or more asynchronous lines and enter the **autocommand x28** command:

```
Router(config)# line 1 2
Router(config-line)# autocommand x28
```

Using Incoming Telnet

An incoming Telnet connection originates from a TCP/IP network. This connection method is used for a two-step connection from an IP device to an X.25 device.

To set up an incoming Telnet connection on the router, perform the following the steps:

-
- Step 1** Telnet to the PAD facility inside the router.

- Step 2** Instruct the PAD to connect to the X.25 device by configuring a range of virtual terminal lines to contain the **autocommand x28** command and the **rotary number** command:

```
Router# configure terminal
Enter configuration commands, one per line. End with CNTL/Z.
Router(config)# line vty 0 4
Router(config-line)# autocommand x28
Router(config-line)# rotary 1
Router(config-line)# exit
Router(config)#
```

- Step 3** Assign an alternate IP address to the rotary port using the **ip alias** command:

```
Router(config)# ip alias aaa.bbb.ccc.ddd 3022
```

In this example, **22** is the rotary number assigned. The field **aaa.bbb.ccc.ddd** is an additional IP address assigned to the router for X.28 PAD mode incoming calls.

- Step 4** The remote user accesses X.28 mode on the router by entering the **telnet aaa.bbb.ccc.ddd** command from the IP host. If required, login options can be specified on this vty.

```
ip-host% telnet 172.19.90.18

Trying 172.19.90.18...
Connected to 172.19.90.18.
Escape character is '^]'.

User Access Verification
Username: letmein
Password: guessme
```

*

Using Incoming X.25

An incoming X.25 connection originates from an X.25 network. This connection method is an unlikely scenario because most users likely are already connected to an X.25 host. However, this configuration is useful for circumventing security restrictions.

To set up incoming X.25 connection on the router, configure a range of virtual terminal lines with the **autocommand x28** command and specify a rotary number with the **rotary number** command.

```
Router# configure terminal
Enter configuration commands, one per line. End with CNTL/Z.
Router(config)# line vty 0 4
Router(config-line)# autocommand x28
Router(config-line)# rotary 1
```

The remote user can now access X.28 mode by initiating a connection to the X.21 address AAAAxx, where AAAA is the X.21 address of the router and xx is the specified rotary number.

Making X.25 PAD Calls over IP Networks

PAD calls can be made to destinations that are not reachable over physical X.25 interfaces, but instead over TCP tunnels. PAD calls originating from a router on an IP link can reach an X.25 device. This feature is also known as PAD over XOT (X.25 over TCP). The **service pad to-xot** command and **service pad from-xot** global configuration command enable the PAD over XOT feature. Figure 4 shows PAD calls originating from a router in an IP network reaching an X.25 device.

Figure 4 PAD Dialing In to an X.25 Host over an IP Network

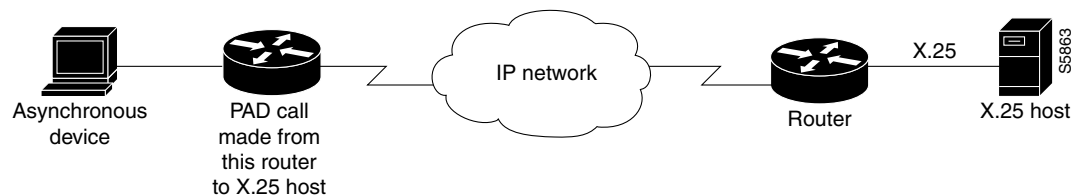

To allow PAD connections over XOT on the router, use the following commands beginning in privileged EXEC mode:

	Command	Purpose
Step 1	Router# configure terminal	Enters global configuration mode.
Step 2	Router(config)# service pad [from-xot] [to-xot]	Specifies outgoing PAD calls over XOT or incoming XOT to PAD connections.
Step 3	Router(config)# x25 host <i>name</i> <i>x121-address</i> or Router(config)# x25 route <i>x121-address</i> xot <i>x121-address</i>	Depending on your application, specifies an X.121 address for the host name of the router or an X.25 route pointing out over XOT. ¹

1. The X.121 address of the **x25 host** command serves as a source address or sink address for PAD over XOT connections that do not have an interface. Protocol translation can also be used with incoming PAD calls over XOT, which is configured with the **translate x25** command.

Configuring PAD Subaddressing

In situations where the X.121 calling address is not sufficient to identify the source of the call, you can append a specified value to the calling address using the PAD subaddressing feature. PAD subaddressing allows you to create unique X.121 calling addresses by including either a physical port number or a value specified for a line as a subaddress to the X.121 calling address.

PAD subaddressing enables an X.25 host application to uniquely identify the source of an X.121 call. For example, in some bank security alarm applications, the central alarm host identifies the physical location of the alarm units from subaddressing information contained in the Call Request packet.



Note

For an example showing PAD address substitution, see the section “[Address Substitution for PAD Calls Example](#)” in this chapter.

Before you can configure PAD subaddressing, you need to configure your router or access server to support X.25. For more information, refer to the *Cisco IOS Wide-Area Networking Configuration Guide*, Release 12.2.

To configure PAD subaddressing, use the following commands beginning in privileged EXEC mode:

	Command	Purpose
Step 1	Router# configure terminal	Enters global configuration mode.
Step 2	Router(config)# line [aux console tty vty] <i>line-number</i> [<i>ending-line-number</i>]	Identifies the line(s) whose information will be appended to the X.121 address as the subaddress.
Step 3	Router(config-line)# x25 subaddress { line <i>number</i> }	Creates a unique X.121 calling address by adding either a physical port number or a numeric value for a line as a subaddress to the X.121 calling address.

Configuring X.29 Reselect

Cisco supports X.29 reselect, which is a standard Triple-X PAD function supported in later versions of the X.3, X.28, and X.29 specifications. X.29 reselect is used in conjunction with mnemonics and autoconnect/autocall to the “first host.” X.29 reselect is for security checking and DNS, such as the X.25 naming/selection of destinations within a public or private network. The primary (first) destination host acts much like a RADIUS/TACACS server. At a minimum, both the PAD and the “first host” used in the topology need to support X.29 reselect. X.29 reselect is transparent to network elements or switches. No Cisco IOS commands need to be entered to enable X.29 reselect. It is enabled by default.

Using Mnemonic Addressing

Mnemonic addressing enables you to connect to a remote host by using its mnemonic address, not the X.121 address. As the number of hosts grows within an X.25 network, system administrators need to remember numerous 14-digit X.121 addresses to connect to multiple host applications. To ease the burden of this administrative overhead, asynchronous PAD users can now access hosts by using mnemonic (abbreviated) addressing.

When the user specifies the mnemonic address in the **call** X.28 command, the mnemonic gets translated to an X.121 address in the local PAD. The resulting call request contains both the X.121 calling and called addresses.

**Note**

For an example showing PAD address substitution, see the section “[Address Substitution for PAD Calls Example](#)” in this chapter.

Character Limitations

You can use the following formats to specify a mnemonic address:

- Any combination of numbers, letters, and special characters preceded by a dot, or period (.)
- Up to 250 characters in one address

**Note**

All other facilities provided in X.28 emulation mode remain the same.

Mnemonic Format Options

This section provides examples of format options.

Example 1

Format

```
c <NUI, Facilities>-.<Mnemonic>*<call-user-data>
```

Description

This is the generalized format of the **call** command where you can specify NUI and facilities with **-.mnemonics** and an asterisk (*) before the call user data (CUD). The comma (,) separates individual facility specifications.

Example Syntax

Nsmith-.billing*xyz

In this example, the following facilities are specified:

```
smith = NUI and no facilities
billing = 31xx4085272478
xyz = CUD
```

Example 2**Format**

c .<Mnemonic>*<call-user-data>

Description

No facilities, with CUD.

Example Syntax

c .billing*xyz

In this example, the following facility is specified:

```
billing = 31xx4085272478 with CUD of xyz
```

Example 3**Format**

c <Mnemonic>

Description

No dot, no facilities, no CUD.

Example syntax

billing

In this example, the following facility is specified:

```
billing = 31xx4085272478
```

Example 4**Format**

<Mnemonic>

Description

No dot, no facilities, no CUD.

Example Syntax**billing**

In this example, the following facility is specified:

```
billing = 31xx4085272478
```

Facility Codes

[Table 3](#) lists the supported facility codes that can be specified in the Call Request packet. The X.121 address is a *word* with decimal digits.

Table 3 Facility Codes

Code	Description
N <i>word</i>	NUI.
T <i>word</i>	Recognized Private Operating Agency (RPOA).
R	Reverse charge.
G <i>word</i>	Closed user group (<i>word</i> is one or two decimal digits).
O <i>word</i>	Closed user group with outgoing access (<i>word</i> is one or two decimal digits).
C	Charging information.
E <i>word</i>	Called address (<i>word</i> is up to 40 decimal digits).
F	Fast select with no restrictions.
S	Reselect prevention.
Q	Fast select with restrictions.

PAD Examples

This section provides the following PAD connection and configuration examples:

- [PAD EXEC User Interface Connection Examples](#)
- [Cisco Universal X.28 PAD Emulation Mode Examples](#)
- [PAD XOT Examples](#)
- [PAD Subaddressing Examples](#)

PAD EXEC User Interface Connection Examples

This section provides the following examples of making PAD connections using the **pad** command:

- [PAD Mode Connection Examples](#)
- [X.3 Parameter Customization Example](#)
- [Load an X.3 Profile Example](#)
- [Set PAD Parameters Example](#)

PAD Mode Connection Examples

The following examples show two ways to make a call to a remote X.25 host over a serial line. The interface address of the remote host is 123456. In the first example, Router-A calls Router-B using the **pad 123456** EXEC command. The second example shows Router-A calling Router-B using the **call 123456** PAD signal command in X.28 mode. Both commands accomplish the same goal.

```
Router-A# pad 123456
Trying 123456...Open

Router-B> exit

[Connection to 123456 closed by foreign host]
```

```
Router-A# x28

* call 123456
COM

Router-B>
```

The following examples show two ways to clear a connection with a remote X.25 host. The first example shows Router-A disconnecting from Router-B using the **disconnect** command in EXEC mode. The second example shows Router-B disconnecting from Router-A using the **clr** command in X.28 mode.

```
Router-A# pad 123456
Trying 123456...Open

Router-B> <Enter the escape sequence (for example, press Shift-Ctrl-^-x).>

Router-A# disconnect
Closing connection to 123456 [confirm]
Router-A#

Router-A# x28

* call 123456
COM

Router-B> <Press Ctrl-p>
* clr

CLR CONF

*
```

X.3 Parameter Customization Example

The following example shows how to change a local X.3 PAD parameter from a remote X.25 host using X.29 messages, which is a secure way to enable a remote host to gain control of local PAD. The local device is Router-A. The remote host is Router-B. The parameters listed in the ParamsIn field are incoming parameters, which are sent by the remote PAD. The parameters listed in the ParamsOut field are parameters sent by the local PAD.

```
Router-A# pad 123456
Trying 123456...Open

Router-B> x3 2:0
Router-B>

Router-A# show x25 pad
```

```

tty0, connection 1 to host 123456

Total input: 12, control 3, bytes 35. Queued: 0 of 7 (0 bytes).
Total output: 10, control 3, bytes 64.
Flags: 1, State: 3, Last error: 1
ParamsIn: 1:0, 2:0, 3:0, 4:0, 5:0, 6:0, 7:0,
          8:0, 9:0, 10:0, 11:0, 12:0, 13:0, 14:0, 15:0,
          16:0, 17:0, 18:0, 19:0, 20:0, 21:0, 22:0,
ParamsOut: 1:1, 2:0, 3:2, 4:1, 5:1, 6:0, 7:21,
           8:0, 9:1, 10:0, 11:14, 12:1, 13:0, 14:0, 15:0,
           16:127, 17:21, 18:18, 19:0, 20:0, 21:0, 22:0,
Router-A#

```

Load an X.3 Profile Example

The following example modifies and loads an existing X.25 PAD parameter profile. It accesses the existing PAD profile `ppp`, changes its padding parameter (specified as 9) to a value of 2, and displays the new parameters using the `par` command in X.28 mode.

```

Router-A# configure terminal
Enter configuration commands, one per line. End with CNTL/Z.
Router-A(config)# x29 profile ppp 9:2
Router-A(config)# end
Router-A#
%SYS-5-CONFIG_I: Configured from console by console
Router-A# x28 profile ppp

* par
  PAR 1:1 2:1 3:126 4:0 5:1 6:2 7:2 8:0 9:2 10:0 11:14 12:1 13:0 14:0 15:0 16:127 17:24
  18:18 19:2 20:0 21:0 22:0

```



Note

If the X.29 profile is set to **default**, the profile is applied to all incoming X.25 PAD calls, including the calls used for protocol translation.

Set PAD Parameters Example

The following example starts a PAD session:

```

Router> pad 123456789
Trying 123456789...Open
Router2>

```

The following example shows how to reset the outgoing connection default for local echo mode on a router. The `/set` switch sets the X.3 parameters defined by parameter number and value, separated by a colon.

```

Router> resume 3 /set 2:1

```

The following are examples of `show x25 vc` command output for PAD over Connection-Mode Network Service (CMNS), PAD to PAD over X.25, and PAD over XOT (X.25 over TCP) connections:

```

Router# show x25 vc

SVC 1, State: D1, Interface: Ethernet0
Started 00:01:48, last input 00:01:48, output 00:01:48

Line: 0 con 0 Location: console Host: 2193330
connected to 2193330 PAD <--> CMNS Ethernet0 00e0.b0e3.0d62

```

```

Window size input: 2, output: 2
Packet size input: 128, output: 128
PS: 2 PR: 3 ACK: 3 Remote PR: 2 RCNT: 0 RNR: no
P/D state timeouts: 0 timer (secs): 0
data bytes 54/19 packets 2/3 Resets 0/0 RNRs 0/0 REJs 0/0 INTs 0/0

SVC 1024, State: D1, Interface: Serial1
  Started 00:00:07, last input 00:00:26, output 00:00:26

Line: 0 con 0 Location: console Host: 2194443
2191111 connected to 2194443 PAD <--> X25

Window size input: 5, output: 5
Packet size input: 128, output: 128
PS: 0 PR: 0 ACK: 0 Remote PR: 0 RCNT: 0 RNR: no
P/D state timeouts: 0 timer (secs): 0
data bytes 0/0 packets 0/0 Resets 0/0 RNRs 0/0 REJs 0/0 INTs 0/0

SVC 1, State: D1, Interface: [172.21.9.7,1998/172.21.9.11,11000]
  Started 00:06:48, last input 00:06:43, output 00:06:43

Line: 0 con 0 Location: console Host: 219444001
2191111 connected to 219444001 PAD <--> XOT 172.21.9.7,1998

Window size input: 2, output: 2
Packet size input: 128, output: 128
PS: 5 PR: 4 ACK: 4 Remote PR: 5 RCNT: 0 RNR: no
P/D state timeouts: 0 timer (secs): 0
data bytes

```

The following example shows output for the **show x25 pad** command:

```

Router# show x25 pad

tty0 (console), connection 1 to host 2194440

Total input: 75, control 2, bytes 3168. Input Queued: 0 of 7 (0 bytes).
Total output: 50, control 2, bytes 52. Output Queued: 0 of 5.
Flags: 1, State: 3, Last error: 1
ParamsIn: 1:0, 2:0, 3:0, 4:0, 5:0, 6:0, 7:0,
          8:0, 9:0, 10:0, 11:0, 12:0, 13:0, 14:0, 15:0,
          16:0, 17:0, 18:0, 19:0, 20:0, 21:0, 22:0,
ParamsOut: 1:1, 2:0, 3:2, 4:1, 5:1, 6:0, 7:21,
           8:0, 9:0, 10:0, 11:14, 12:1, 13:0, 14:0, 15:0,
           16:127, 17:21, 18:18, 19:0, 20:0, 21:0, 22:0,

tty18, Incoming PAD connection
Total input: 2, control 2, bytes 54. Input Queued: 0 of 7 (0 bytes).
Total output: 1, control 2, bytes 9. Output Queued: 0 of 5.
Flags: 1, State: 3, Last error: 1
ParamsIn: 1:1, 2:0, 3:2, 4:1, 5:0, 6:0, 7:21,
          8:0, 9:0, 10:0, 11:14, 12:0, 13:0, 14:0, 15:0,
          16:127, 17:21, 18:18, 19:0, 20:0, 21:0, 22:0,
ParamsOut: 1:1, 2:1, 3:2, 4:1, 5:0, 6:0, 7:4,
           8:0, 9:0, 10:0, 11:14, 12:0, 13:0, 14:0, 15:0,
           16:127, 17:21, 18:18, 19:0, 20:0, 21:0, 22:0,

```

Cisco Universal X.28 PAD Emulation Mode Examples

This section contains the following examples of making PAD connections using the **x28** command:

- [Set Parameters Using X.28 PAD Emulation Mode Example](#)
- [NUI Data Relocation Example](#)
- [X.25 Reverse Charge Example](#)
- [X.25 Call Detail Display Example](#)
- [Set PAD French Service Signals in X.28 Mode Example](#)
- [Set PAD French Service Signals with an X.29 Profile Example](#)
- [Get Help Example](#)

Set Parameters Using X.28 PAD Emulation Mode Example

The following example configures parameter 9 from 0 to 1, which adds a byte after the carriage return. This setting is performed from a local terminal using the `set parameter-number:new-value` PAD command signal.

```
Router# x28

* par
  PAR 1:1 2:1 3:126 4:0 5:1 6:2 7:2 8:0 9:0 10:0 11:14 12:1 13:0 14:0 15:0 16:127 17:24
  18:18 19:2 20:0 21:0 22:0

* set 9:1

* par
  PAR 1:1 2:1 3:126 4:0 5:1 6:2 7:2 8:0 9:1 10:0 11:14 12:1 13:0 14:0 15:0 16:127 17:24
  18:18 19:2 20:0 21:0 22:0

*
```

NUI Data Relocation Example

The following example sends an authentication message to a remote X.25 host using the `x28 nuicud` command in Cisco X.28 mode followed by the `Ncisc-123456` command. The network identifier is N. The network user password is cisc. The destination address of the remote device is 123456. The ASCII representation of the user password appears in the CUD field, not in the data packet.

```
Router-A# debug x25 event
X.25 special event debugging is on
Router-A# x28 nuicud

* Ncisc-123456
COM

Router-B>
02:02:58: Serial1: X.25 O P1 Call (16) 8 lci 20
02:02:58:   From(3): 222 To(3): 123456
02:02:58:   Facilities: (0)
02:02:58:   Call User Data (8): 0x01000000xxxxxxxx (pad)
02:02:58: Serial1: X.25 I P2 Call Confirm (5) 8 lci 20
02:02:58:   From(0): To(0):
02:02:58:   Facilities: (0)
```

X.25 Reverse Charge Example

The following example shows how to use the **x28 reverse** command to make the charges for all outgoing calls made from the local router be reversed to the destination device. To reverse the charges for only one outgoing call, use the **R-address** command, which is the standard X.28 reverse charge facility command.

```
Router-A# x28 reverse
* exit
Router-A# x28
* R-123456
COM
```

X.25 Call Detail Display Example

Each time a call is made to a remote device, you can specify that detailed information be displayed about the call and the destination device by entering the **x28 verbose** command. The following example shows reverse charging configured and CUD represented as userdata:

```
Router# x28 verbose
* R-111*userdata
Called DTE Address : 3001
Facility Block      : R
Call User Data      :userdata
COM
```

Set PAD French Service Signals in X.28 Mode Example

The following example shows PAD French enhancement being set in X.28 EXEC mode:

```
Router # x28
* set 6:9
```

Set PAD French Service Signals with an X.29 Profile Example

The following example shows PAD French enhancement being set with an X.29 profile:

```
Router(config)# x29 profile Primary 6:9
```

Get Help Example

The following example shows how to use the **help** command to get short descriptions of the available parameters:

```
* help
The "help" PAD command signal consists of the following elements:
<help PAD command signal> <help subject>
  where
  <help subject> is the identifier for the type of
  explanatory information requested
* help break
BREAK      Simulate async BREAK
```

PAD XOT Examples

The following sections provide PAD over XOT configuration examples:

- [Accept XOT to PAD Connections Example](#)
- [Accept XOT to Protocol Translation Example](#)
- [Initiate a PAD Call over an XOT Connection Example](#)
- [Address Substitution for PAD Calls Example](#)

Accept XOT to PAD Connections Example

The following example enables connections from XOT to a local PAD. Because XOT is a TCP connection, the connection is not tied to an X.25 interface. An X.25 address must be configured for the host name of the router that is accepting the call. In this case, the router answers and clears an incoming PAD call through address 1234.

```
Router(config)# service pad from-xot
Router(config)# x25 host Router-A 1234
```

Accept XOT to Protocol Translation Example

The following example accepts an incoming PAD call over XOT to address 12345. The router then translates the call and makes a TCP connection to the device named puli.

```
Router(config)# service pad from-xot
Router(config)# translate x25 12345 tcp puli
```

Initiate a PAD Call over an XOT Connection Example

The following example enables outgoing PAD to XOT connections from an asynchronous line or vty. A route pointing out over XOT must be configured on the routing table to make a PAD call. This route can also be used for switching.

```
Router(config)# service pad to-xot
Router(config)# x25 route 1111 xot 10.2.2.2.
```

Address Substitution for PAD Calls Example

X.25 synchronous or PAD devices attached to a router in a remote location may need to ensure that outgoing PAD calls use an assigned X.121 address for the calling (source) address or an assigned X.121 address for the called (destination) address.

Normally, the called address is sent by default in the outgoing PAD call. For the source address, the PAD applies the address for the originating interface (even if it is NULL) or the X.25 host address (for example, XOT) as the source address of the call. To override the default behavior and substitute the original X.121 source/destination address in the outgoing PAD calls, use the **x25 route** command with the **substitute-source** and **substitute-dest** keyword options.

**Note**

Address substitution can be applied to all PAD connections, not just PAD over XOT.

Configuring Address Substitution

The following example performs address substitution for PAD calls over XOT:

```
Router(config)# x25 route ^1234 substitute-source 5678 xot 10.1.1.1
```

or

```
Router(config)# x25 route ^1234 substitute-dest 5678 interface serial 1
```

Verifying Address Substitution

To verify the source or destination address substitution on the outgoing PAD call, use the **debug x25 event** command and **show x25 vc** command.

For example, to substitute the destination address of 8888 to 5678 and replace the default source address of the outgoing PAD call to 1234, enter the following **x25 route** command:

```
Router(config)# x25 route 8888 substitute-source 1234 substitute-dest 5678 interface serial 1
```

Placing a PAD call to destination 8888 will be substituted by 5678 and a source address of 1234:

```
Router# pad 8888
```

```
Trying 8888...Open
```

The following is output of the **x25 debug event** command:

```
Serial1: X.25 O R1 Call (13) 8 lci 1024
  From(4): 1234 To(4): 5678
  Facilities: (0)
  Call User Data (4): 0x01000000 (pad)
Serial1: X.25 I R1 Call Confirm (5) 8 lci 1024
  From(0): To(0):
  Facilities: (0)
```

The following is output from the **show x25 vc** command:

```
Router# show x25 vc

SVC 1024, State: D1, Interface: Serial1
  Started 00:23:54, last input 00:00:13, output 00:00:13

Line: 0 con 0 Location: console Host: 456
1234 connected to 5678 PAD <--> X25

Window size input: 2, output: 2
Packet size input: 128, output: 128
PS: 0 PR: 0 ACK: 0 Remote PR: 0 RCNT: 0 RNR: no
P/D state timeouts: 0 timer (secs): 0
data bytes 68/958 packets 16/27 Resets 0/0 RNRs 0/0 REJs 0/0 INTs 0/0
```

PAD Subaddressing Examples

The following example shows how to configure subaddressing on virtual terminal lines 10 through 20 by appending the line number as a subaddress to the X.121 calling address:

```
Router(config)# line vty 10 20
Router(config-line)# x25 subaddress line
```

The following example shows how to configure subaddressing on the first five TTY lines by appending the value 9 as a subaddress to the X.121 calling address of the X.28 connection originating on these lines:

```
Router(config-line)# line 1 5
Router(config-line)# x25 subaddress 9
Router(config-line)# autocmd x28
```

You can use the output from the **debug x25 event** and the **show line** commands to display information about PAD subaddressing. Once you have configured PAD subaddressing, the output from both of these commands changes to reflect the additional subaddress information.

The following example shows **debug x25 event** output, where the X.25 address is 12345 and the subaddress for TTY line 3 is 09:

```
Router# debug x25 event

Serial1: X.25 O P1 Call (14) 8 lci 1024
  From(7): 1234509 To(4): 6789
  Facilities: (0)
  Call User Data (4): 0x01000000 (pad)
Serial1: X.25 I P2 Call Confirm (5) 8 lci 1024
  From (0): to (0):
  Facilities: (0)
  PAD3: Call completed
```

The following example shows sample **show line** output for a router named *enkidu*, where line 18 has been configured for PAD subaddressing:

```
Router# show line 18

Tty Typ      Tx/Rx      A Modem  Roty   AccO   AccI   Uses   Noise  Overruns
 18  VTY                - -      - -     - -     1     0     0/0

Line 18, Location: "enkidu", Type: " "
Length: 48 lines, Width: 80 columns
Baud rate: (TX/RX) is 9600/9600
Status: Ready, Connected, Active, No Exit Banner
Capabilities: Line usable as async interface, PAD Sub-addressing used
Modem state: Ready
```

CCDE, CCENT, Cisco Eos, Cisco Lumin, Cisco Nexus, Cisco StadiumVision, Cisco TelePresence, Cisco WebEx, the Cisco logo, DCE, and Welcome to the Human Network are trademarks; Changing the Way We Work, Live, Play, and Learn and Cisco Store are service marks; and Access Registrar, Aironet, AsyncOS, Bringing the Meeting To You, Catalyst, CCDA, CCDP, CCIE, CCIP, CCNA, CCNP, CCSP, CCVP, Cisco, the Cisco Certified Internetwork Expert logo, Cisco IOS, Cisco Press, Cisco Systems, Cisco Systems Capital, the Cisco Systems logo, Cisco Unity, Collaboration Without Limitation, EtherFast, EtherSwitch, Event Center, Fast Step, Follow Me Browsing, FormShare, GigaDrive, HomeLink, Internet Quotient, IOS, iPhone, iQuick Study, IronPort, the IronPort logo, LightStream, Linksys, MediaTone, MeetingPlace, MeetingPlace Chime Sound, MGX, Networkers, Networking Academy, Network Registrar, PCNow, PIX, PowerPanels, ProConnect, ScriptShare, SenderBase, SMARTnet, Spectrum Expert, StackWise, The Fastest Way to Increase Your Internet Quotient, TransPath, WebEx, and the WebEx logo are registered trademarks of Cisco Systems, Inc. and/or its affiliates in the United States and certain other countries.

All other trademarks mentioned in this document or website are the property of their respective owners. The use of the word partner does not imply a partnership relationship between Cisco and any other company. (0809R)

Any Internet Protocol (IP) addresses used in this document are not intended to be actual addresses. Any examples, command display output, and figures included in the document are shown for illustrative purposes only. Any use of actual IP addresses in illustrative content is unintentional and coincidental.

© 2008 Cisco Systems, Inc. All rights reserved.

