



Configuring Broadband Access: PPP and Routed Bridge Encapsulation

This chapter describes how to configure a central office aggregator for broadband access using PPP or ATM routed bridge encapsulation.

This chapter includes the following sections:

- [Configuring PPP over ATM](#)
- [Configuring PPPoE over ATM](#)
- [Configuring PPPoE over Ethernet](#)
- [Configuring PPPoE over IEEE 802.1Q VLANs](#)
- [Configuring RADIUS Port Identification for PPP](#)
- [Configuring ATM Routed Bridge Encapsulation](#)
- [Configuring an ATM PVC Range](#)
- [Configuration Examples](#)

For further general information about broadband access using PPP or ATM routed bridge encapsulation, see the “[Wide-Area Networking Overview](#)” chapter at the beginning of this book.

For a complete description of the commands in this chapter that are specific to broadband access configuration, refer to the chapter “Broadband Access: PPP and Routed Bridge Encapsulation Commands” in the *Cisco IOS Wide-Area Networking Command Reference*. To locate documentation of other commands that appear in this chapter, use the command reference master index or search online.

To identify the hardware platform or software image information associated with a feature, use the Feature Navigator on Cisco.com to search for information about the feature or refer to the software release notes for a specific release. For more information, see the section “[Identifying Supported Platforms](#)” in the chapter “Using Cisco IOS Software.”

Configuring PPP over ATM

PPP over ATM can be configured on all platforms running Cisco IOS Release 12.1 or later, except for IETF-compliant LLC encapsulated PPP over ATM, which is not available for the Cisco MC3810 series platform.



Note

All forms of PPP over ATM are now supported on the ATM port adapters, except for the PA-A1 ATM port adapter for Cisco IOS Release 12.1. All forms of PPP over ATM are now supported on the enhanced ATM port adapter for Cisco IOS Release 12.1 or later.

Figure 10 shows a typical scenario for using Cisco-proprietary PPP over ATM.

Figure 10 PPP-over-ATM Network Environment

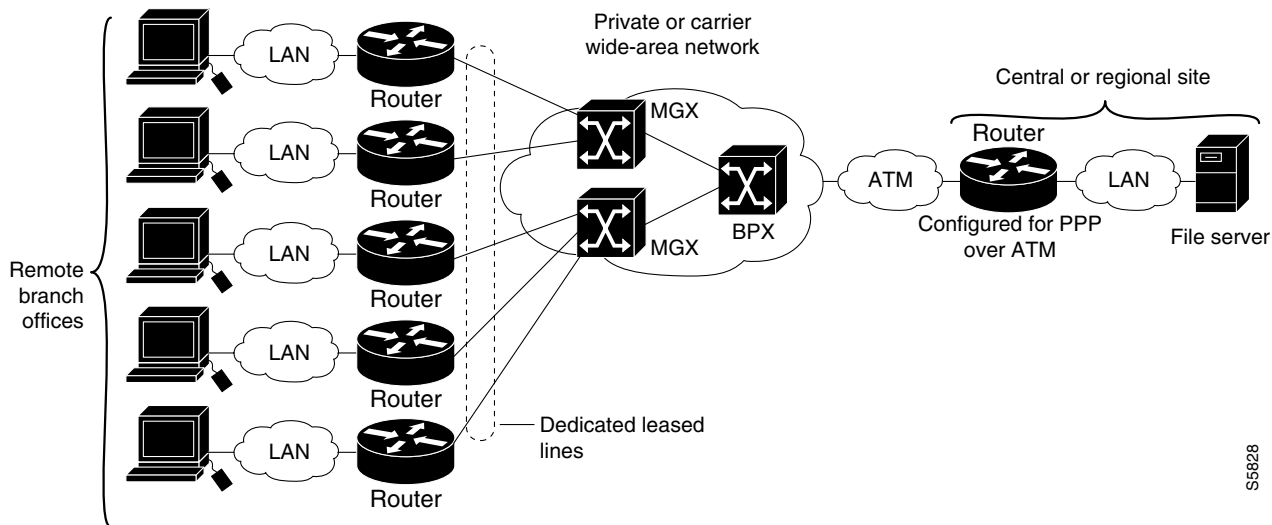

Note

If you need to configure the Cisco MGX 8220 shelf for frame forwarding at the remote sites, refer to the *Cisco MGX 8220 Command Supplement* for command line instructions or the *Cisco StrataView Plus Operations Guide* for StrataView Plus instructions. If you configure the MGX using the command line interface, use the **addport** and **addchan** commands and select frame forwarding for the *port_type* and *chan_type* arguments, respectively.

When you configure PPP over ATM, a logical interface known as a *virtual access interface* associates each PPP connection with an ATM VC. You can create this logical interface by configuring an ATM PVC or SVC. This configuration encapsulates each PPP connection in a separate PVC or SVC, allowing each PPP connection to terminate at the router ATM interface as if received from a typical PPP serial interface.

The virtual access interface for each VC obtains its configuration from a virtual interface template (virtual template) when the VC is created. Before you create the ATM VC, it is recommended that you create and configure a virtual template as described in the section “[Creating and Configuring a Virtual Template](#),” next.

Once you have configured the router for PPP over ATM, the PPP subsystem starts and the router attempts to send a PPP configure request to the remote peer. If the peer does not respond, the router periodically goes into a “listen” state and waits for a configuration request from the peer. After a timeout (typically 45 seconds), the router again attempts to reach the remote router by sending configuration requests.

The virtual access interface remains associated with a VC as long as the VC is configured. If you deconfigure the VC, the virtual access interface is marked as deleted. If you shut down the associated ATM interface, you will also cause the virtual access interface to be marked as down (within 10 seconds), and you will bring the PPP connection down. If you set a keepalive timer of the virtual template on the interface, the virtual access interface uses the PPP echo mechanism to verify the existence of the remote peer.

The following three types of PPP over ATM connections are supported:

- IETF-compliant MUX encapsulated PPP over ATM
- IETF-compliant LLC encapsulated PPP over ATM
- Cisco-proprietary PPP over ATM

PPP over ATM Configuration Task List

To configure PPP over ATM, complete the tasks described in the following sections. Each task is identified as optional or required:

- [Creating and Configuring a Virtual Template](#) (Optional, but recommended)
- [Configuring IETF-Compliant MUX Encapsulated PPP over ATM PVCs](#) (Optional)
- [Configuring IETF-Compliant LLC Encapsulated PPP over ATM PVCs](#) (Optional)
- [Configuring Cisco-Proprietary PPP over ATM PVCs](#) (Optional)
- [Configuring PPP over ATM SVCs](#) (Optional)

Creating and Configuring a Virtual Template

Prior to configuring the ATM PVC for PPP over ATM, you typically create and configure a virtual template. To create and configure a virtual template, use the following commands beginning in global configuration mode:

	Command	Purpose
Step 1	Router(config)# interface virtual-template <i>number</i>	Creates a virtual template, and enter interface configuration mode.
Step 2	Router(config-if)# encapsulation ppp	Enables PPP encapsulation on the virtual template.
Step 3	Router(config-if)# ip unnumbered ethernet <i>number</i>	(Optional) Enables IP without assigning a specific IP address on the LAN.

Other optional configuration commands can be added to the virtual template configuration. For example, you can enable the PPP authentication on the virtual template using the **ppp authentication chap** command. Refer to the “Configuring Virtual Template Interfaces” chapter in the *Cisco IOS Dial Technologies Configuration Guide* for additional information about configuring the virtual template.

All PPP parameters are managed within the virtual template configuration. Configuration changes made to the virtual template are automatically propagated to the individual virtual access interfaces. Multiple virtual access interfaces can originate from a single virtual template; therefore, multiple PVCs can use a single virtual template.

Cisco IOS software supports up to 25 virtual template configurations. If greater numbers of tailored configurations are required, an authentication, authorization, and accounting (AAA) server may be employed. Refer to the “Configuring Per-User Configuration” chapter in the *Cisco IOS Dial Technologies Configuration Guide* for additional information on configuring an AAA server.

If the parameters of the virtual template are not explicitly defined before the ATM PVC is configured, the PPP interface is brought up using default values from the virtual template identified. Some parameters (such as an IP address) take effect only if specified before the PPP interface comes up. Therefore, it is recommended that you explicitly create and configure the virtual template before configuring the ATM PVC to ensure that such parameters take effect. Alternatively, if parameters are

specified after the ATM PVC has already been configured, use the **shutdown** command followed by a **no shutdown** command on the ATM subinterface to restart the interface; this restart will cause the newly configured parameters (such as an IP address) to take effect.

Network addresses for the PPP-over-ATM connections are not configured on the main ATM interface or subinterface. Instead, these are configured on the appropriate virtual template or obtained via AAA.

The virtual templates support all standard PPP configuration commands; however, not all configurations are supported by the PPP-over-ATM virtual access interfaces. These restrictions are enforced at the time the virtual template configuration is applied (cloned) to the virtual access interface. These restrictions are described in the following paragraphs.

Only standard FIFO queuing is supported when applied to PPP-over-ATM virtual access interfaces. Other types of queuing which are typically configured on the main interface are not (for example, fair queuing). If configured, these configuration lines are ignored when applied to a PPP-over-ATM interface.

Although fast switching is supported, flow and optimum switching are not; these configurations are ignored on the PPP-over-ATM virtual access interface. Fast switching is enabled by default for the virtual template configuration. If fast switching is not desired, use the **no ip route-cache** command to disable it.

The PPP reliable link that uses Link Access Procedure, Balanced (LAPB) is not supported.

Because an ATM PVC or SVC is configured for this feature, the following standard PPP features are not applicable and should not be configured:

- Asynchronous interfaces
- Dialup connections
- Callback on PPP

Configuring IETF-Compliant MUX Encapsulated PPP over ATM PVCs

IETF-compliant MUX encapsulated PPP over ATM, also known as null encapsulation, allows you to configure PPP over ATM using a virtual circuit (VC) multiplexed encapsulation mode. This feature complies with IETF RF 2364 entitled *PPP over AAL5*.

You can configure ATM PVCs for IETF-compliant MUX encapsulated PPP over ATM on either point-to-point or multipoint subinterfaces. Multiple PVCs on multipoint subinterfaces significantly increase the maximum number of PPP-over-ATM sessions running on a router.

To configure a PVC with IETF-compliant MUX PPP over ATM that supports VC multiplexed PPP payloads, use the following commands starting in global configuration mode:

	Command	Purpose
Step 1	<pre>Router(config)# interface atm slot/port.subinterface-number point-to-point</pre> <p>or</p> <pre>Router(config)# interface atm number.subinterface-number point-to-point</pre> <p>or</p> <pre>Router(config)# interface atm slot/port.subinterface-number multipoint</pre> <p>or</p> <pre>Router(config)# interface atm number.subinterface-number multipoint</pre>	Specifies an ATM point-to-point or multipoint subinterface using the appropriate format of the interface atm command. ¹
Step 2	<pre>Router(config-subif)# pvc [name] vpi/vci</pre>	Configures the PVC.
Step 3	<pre>Router(config-if-atm-vc)# encapsulation aal5mux ppp virtual-template number</pre>	Configures VC multiplexed encapsulation on a PVC.

1. To determine the correct form of the **interface atm** command, consult your ATM network module, port adapter, or router documentation.

To configure a PVC range with IETF-compliant MUX PPP over ATM that supports VC multiplexed PPP payloads, use the following commands beginning in global configuration mode:

	Command	Purpose
Step 1	<pre>Router(config)# interface atm slot/port.subinterface-number point-to-point</pre> <p>or</p> <pre>Router(config)# interface atm number.subinterface-number point-to-point</pre> <p>or</p> <pre>Router(config)# interface atm slot/port.subinterface-number multipoint</pre> <p>or</p> <pre>Router(config)# interface atm number.subinterface-number multipoint</pre>	Specifies an ATM point-to-point or multipoint subinterface using the appropriate format of the interface atm command. ¹
Step 2	<pre>Router(config-subif)# range [range-name] pvc start-vpi/start-vci end-vpi/end-vci</pre>	Creates a range of PVCs.
Step 3	<pre>Router(config-if-atm-range)# encapsulation aal5mux ppp virtual-template number</pre>	Configures VC multiplexed encapsulation on a PVC range.

1. To determine the correct form of the **interface atm** command, consult your ATM network module, port adapter, or router documentation.

IETF-Compliant PPP over ATM is not supported on ATM SVCs and can only be applied to PVCs.

The IETF-Compliant PPP over ATM feature was designed to support installations with ADSL circuits. For an example of using ADSL termination, see the section “[ADSL Termination Example](#)” under “[PPP over ATM Configuration Examples](#)” at the end of this chapter.

Configuring IETF-Compliant LLC Encapsulated PPP over ATM PVCs

IETF-compliant LLC encapsulated PPP over ATM LLC Encapsulation allows you to configure PPP over ATM with LLC encapsulation. It accommodates Frame Relay-to-ATM service interworking (Frame Relay forum standard FRF.8). There is no equivalent VC multiplexed encapsulation mode for Frame Relay; therefore, LLC encapsulation is required for Frame Relay-to-ATM networking. This version of PPP over ATM also enables you to carry multiprotocol traffic. For example, a VC will carry both PPP and IPX traffic.

Figure 11 illustrates Frame Relay-to-ATM interworking.

Figure 11 Frame Relay-to-ATM Interworking

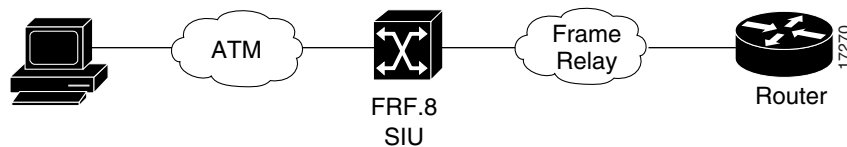

You can configure ATM PVCs for IETF-compliant LLC encapsulated PPP over ATM on either point-to-point or multipoint subinterfaces. Multiple PVCs on multipoint subinterfaces significantly increase the maximum number of PPP-over-ATM sessions running on a router.

To configure IETF-compliant LLC encapsulated PPP over ATM on a PVC, use the following commands beginning in global configuration mode:

	Command	Purpose
Step 1	<pre>Router(config)# interface atm slot/port.subinterface-number point-to-point</pre> <p>or</p> <pre>Router(config)# interface atm number.subinterface-number point-to-point</pre> <p>or</p> <pre>Router(config)# interface atm slot/port.subinterface-number multipoint</pre> <p>or</p> <pre>Router(config)# interface atm number.subinterface-number multipoint</pre>	Specifies an ATM point-to-point or multipoint subinterface using the appropriate format of the interface atm command. ¹
Step 2	<pre>Router(config-subif)# pvc [name] vpi/vci</pre>	Configures the PVC.

	Command	Purpose
Step 3	Router(config-if-atm-vc)# encapsulation aal5snap ²	Configures LLC SNAP encapsulation on the PVC.
Step 4	Router(config-if-atm-vc)# protocol ppp virtual-template number	Configures IETF PPP over ATM LLC Encapsulation on the PVC.

1. To determine the correct form of the **interface atm** command, consult your ATM network module, port adapter, or router documentation.
2. The *snap* encapsulation is a misnomer here, since this encapsulation configures both LLC and SNAP encapsulation on the VC. If *snap* encapsulation is not configured at a lower inheritance level, or another type of encapsulation is configured at a lower inheritance level, you will have to configure both *snap* and the **protocol ppp** command to ensure that PPP over ATM with LLC encapsulation is configured on your VC.

To configure IETF-compliant LLC encapsulated PPP over ATM on a PVC range, use the following commands beginning in global configuration mode:

	Command	Purpose
Step 1	Router(config)# interface atm <i>slot/port.subinterface-number</i> point-to-point or Router(config)# interface atm <i>number.subinterface-number</i> point-to-point or Router(config)# interface atm <i>slot/port.subinterface-number</i> multipoint or Router(config)# interface atm <i>number.subinterface-number</i> multipoint	Specifies an ATM point-to-point or multipoint subinterface using the appropriate format of the interface atm command. ¹
Step 2	Router(config-subif)# range [<i>range-name</i>] pvc <i>start-vpi/start-vci end-vpi/end-vci</i>	Creates a range of PVCs.
Step 3	Router(config-if-atm-range)# encapsulation aal5snap ²	Configures LLC SNAP encapsulation on the PVC range.
Step 4	Router(config-if-atm-range)# protocol ppp virtual-template number	Configures IETF PPP over ATM LLC Encapsulation on the PVC. range

1. To determine the correct form of the **interface atm** command, consult your ATM network module, port adapter, or router documentation.
2. The *snap* encapsulation is a misnomer here, since this encapsulation configures both LLC and SNAP encapsulation on the VC. If *snap* encapsulation is not configured at a lower inheritance level, or another type of encapsulation is configured at a lower inheritance level, you will have to configure both *snap* and the **protocol ppp** command to ensure that PPP over ATM with LLC encapsulation is configured on your VC.

For more information about configuring an ATM PVC range, see the section “[Configuring an ATM PVC Range](#)” later in this chapter.

You can also configure IETF-compliant LLC encapsulated PPP over ATM in a VC class and apply this VC class to an ATM VC, subinterface, or interface. For information about configuring a VC class, refer to the section “[Configuring VC Classes](#)” in the chapter “Configuring ATM.”

**Note**

Depending on whether you configure IETF-compliant LLC encapsulated PPP over ATM directly on a PVC or interface, your PVC will inherit the configuration that takes highest precedence. For a description of the inheritance hierarchy, see the **protocol** command in the *Cisco IOS Wide-Area Networking Command Reference Guide*.

Configuring Cisco-Proprietary PPP over ATM PVCs

You can configure ATM PVCs for Cisco proprietary PPP over ATM on either point-to-point or multipoint subinterfaces. Multiple PVCs on multiple subinterfaces significantly increases the maximum number of PPP-over-ATM sessions running on a router. Remote branch offices must have Cisco proprietary PPP over ATM configured on PPP-compatible devices interconnecting directly to Cisco's ATM Switch Interface Shelf (AXIS) equipment through a leased-line connection. The shelves provide frame forwarding encapsulation and are terminated on BPX cores prior to connecting to a Cisco 7500 series router.

To configure Cisco proprietary PPP over ATM on a PVC, use the following commands starting in global configuration mode:

	Command	Purpose
Step 1	<pre>Router(config)# interface atm slot/port.subinterface-number point-to-point</pre> <p>or</p> <pre>Router(config)# interface atm number.subinterface-number point-to-point</pre> <p>or</p> <pre>Router(config)# interface atm slot/port.subinterface-number multipoint</pre> <p>or</p> <pre>Router(config)# interface atm number.subinterface-number multipoint</pre>	Specifies an ATM point-to-point or multipoint subinterface using the appropriate format of the interface atm command. ¹
Step 2	<pre>Router(config-subif)# pvc [name] vpi/vci</pre>	Configures the PVC.
Step 3	<pre>Router(config-if-atm-vc)# encapsulation aal5cisco virtual-template number</pre>	Configures Cisco Proprietary PPP over ATM encapsulation on the PVC.

1. To determine the correct form of the **interface atm** command, consult your ATM network module, port adapter, or router documentation.

To configure Cisco proprietary PPP over ATM on a PVC range, use the following commands beginning in global configuration mode:

	Command	Purpose
Step 1	<pre>Router(config)# interface atm slot/port.subinterface-number point-to-point</pre> <p>or</p> <pre>Router(config)# interface atm number.subinterface-number point-to-point</pre> <p>or</p> <pre>Router(config)# interface atm slot/port.subinterface-number multipoint</pre> <p>or</p> <pre>Router(config)# interface atm number.subinterface-number multipoint</pre>	Specifies an ATM point-to-point or multipoint subinterface using the appropriate format of the interface atm command. ¹
Step 2	<pre>Router(config-subif)# range [range-name] pvc start-vpi/start-vci end-vpi/end-vci</pre>	Configures the PVC range.
Step 3	<pre>Router(config-if-atm-range)# encapsulation aal5ciscoppp virtual-template number</pre>	Configures Cisco-Proprietary PPP over ATM encapsulation on the PVC range.

1. To determine the correct form of the **interface atm** command, consult your ATM network module, port adapter, or router documentation.

For more information about configuring an ATM PVC range, see the section “[Configuring an ATM PVC Range](#)” later in this chapter.

For an example of configuring Cisco proprietary PPP over ATM, see the section “[Configuring Cisco-Proprietary PPP over ATM PVCs](#)” at the end of this chapter.

Configuring PPP over ATM SVCs

When PPP over ATM is configured over an SVC rather than a PVC, each time an end user initiates a connection to a Network Access Provider (NAP) or Network Service Provider (NSP), an ATM SVC is established using a configured ATM address. A PPP session is then established over the SVC. By using PPP, the NAPs and NSPs can authenticate users and provide suitable access to the various services being offered. Whereas PVCs require that services and destination addresses be predetermined, using PPP over ATM SVCs allows users to choose services and the quality of those services dynamically on the basis of destination address.

[Figure 12](#) shows a typical network topology for PPP over ATM SVCs terminating at an NAP.

Figure 12 PPP over ATM SVC Terminating at an NAP

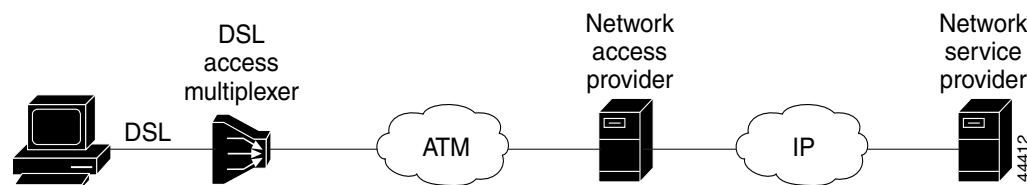
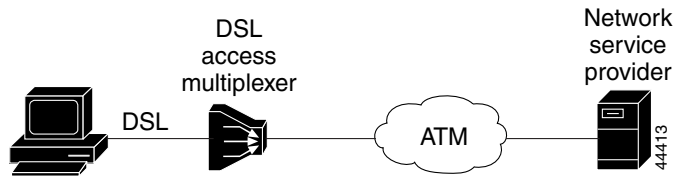

Figure 13 shows a typical network topology of PPP over ATM SVCs terminating at an NSP.

Figure 13 PPP over ATM SVC Terminating at an NSP



The PPP over ATM SVCs feature works by associating each PPP session with a virtual-access interface. Each virtual-access interface is associated with an SVC. The SVCs use static maps that hold information about the encapsulation type and virtual template number. A single static map can accept multiple PPP over ATM SVC calls.

To configure PPP over an ATM SVC, perform the tasks in the following sections. Each task in the list is identified as optional or required.

- [Configuring PPP over an ATM SVC](#) (Required)
- [Setting the ATM NSAP Address](#) (Required)
- [Verifying PPP over ATM SVCs](#) (Optional)

Configuring PPP over an ATM SVC

To configure PPP over an ATM SVC, use the following commands beginning in global configuration mode:

	Command	Purpose
Step 1	<pre>Router(config)# interface atm slot/0</pre> <p>or</p> <pre>Router(config)# interface atm slot/port-adaptor/0</pre> <p>or</p> <pre>Router(config)# interface atm number</pre> <p>or</p> <pre>Router(config)# interface atm slot/port</pre>	Specifies an ATM interface and enters interface configuration mode. To determine the correct form of the interface atm command , consult your ATM network module, port adapter, or router documentation.
Step 2	<pre>Router(config-if)# svc [name]</pre>	Creates an ATM SVC.
Step 3	<pre>Router(config-if-atm-vc)# encapsulation aal5auto</pre>	Specifies encapsulation auto, which allows the SVC to use either aal5snap or aal5mux encapsulation types.
Step 4	<pre>Router(config-if-atm-vc)# protocol ppp</pre> <pre>virtual-template number</pre>	Specifies that PPP is established over the ATM SVC using the configuration from the specified virtual template.

	Command	Purpose
Step 5	Router(config-if-atm-vc)# max vc <i>number</i>	Specifies the maximum number of SVCs that can be established using the current configuration.
Step 6	Router(config-if-atm-vc)# max bandwidth <i>kbps</i>	Specifies the total amount of bandwidth available to all SVCs in the current configuration.

Setting the ATM NSAP Address

To set the network service access point (NSAP) address for the ATM interface, use the following command in interface configuration mode:

Command	Purpose
Router(config-if)# atm nsap-address <i>nsap-address</i>	Sets the NSAP address for an ATM interface.

When configuring an SVC, you must use the **atm nsap-address** command to define the source NSAP address. It identifies a particular port on the ATM network and must be unique across the network.

Verifying PPP over ATM SVCs

To verify the configuration of PPP over ATM SVCs, use the following privileged EXEC command:

Command	Purpose
Router# show atm svc	Display all ATM SVCs and traffic information.
Router# show atm svc ppp	Displays information about each SVC configured for PPP over ATM.

Configuring PPPoE over ATM

PPPoE over ATM provides the ability to connect a network of hosts over a simple bridging-access device to a remote access concentrator. With this model, each host utilizes its own PPPoE stack and the user is presented with a familiar user interface. Access control, billing, and type of service can be configured on a per-user, rather than a per-site, basis. Before a point-to-point connection over Ethernet can be provided, each PPP session must learn the Ethernet address of the remote peer and establish a unique session identifier. A unique session identifier is provided by the PPPoE Discovery Stage protocol.

Figure 14 shows a sample network topology using PPPoE over ATM.

Figure 14 PPPoE over ATM Sample Network Topology

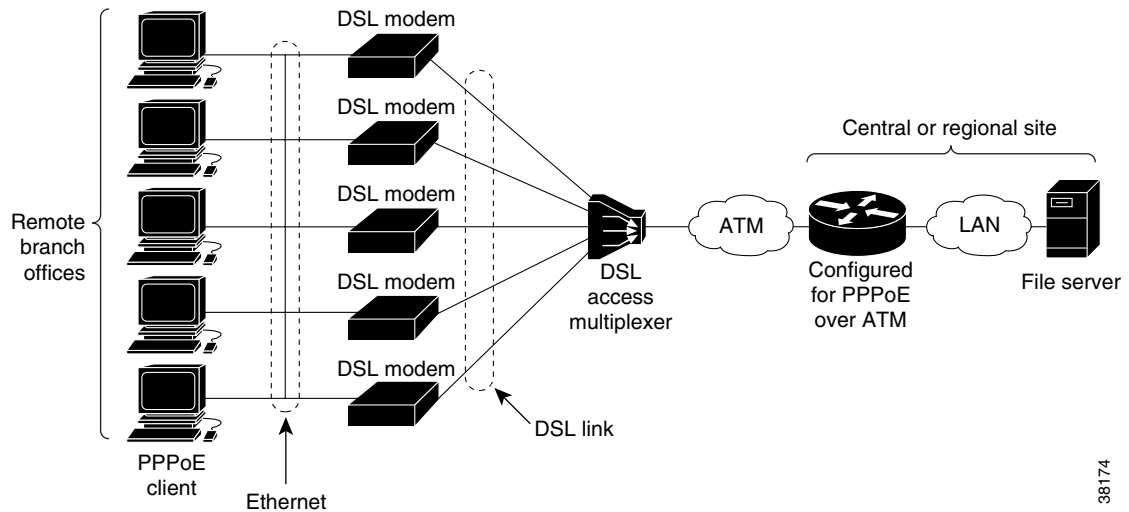

38174

PPPoE Stage Protocols

PPPoE has two distinct stage protocols. The stage protocols are listed and summarized in [Table 6](#).

Table 6 PPPoE Stage Protocols

Stage Protocols	Description
Discovery Stage protocol	Remains stateless until a PPPoE session is established. Once the PPPoE session is established, both the host and the access concentrator <i>must</i> allocate the resources for a PPP virtual access interface.
PPP Session Stage protocol	Once the PPPoE session is established, sends PPPoE data as in any other PPP encapsulation.

There are four steps to the Discovery Stage:

1. Host broadcasts a PPPoE Active Discovery Initiation (PADI) packet.
2. When the access concentrator receives a PADI that it can serve, it replies by sending a PPPoE Active Discovery Offer (PADO) packet to the host.
3. Because the PADI was broadcast, the host may receive more than one PADO packet. The host looks through the PADO packets it receives and chooses one. The choice can be based on the AC name or the services offered. The host then sends a single PPPoE Active Discovery Request (PADR) packet to the access concentrator that it has chosen.
4. When the access concentrator receives a PADR packet, it prepares to begin a PPP session. It generates a unique session ID for the PPPoE session and replies to the host with a PPPoE Active Discovery Session-confirmation (PADS) packet.

When a host wishes to initiate a PPPoE session, it must first perform discovery to identify the Ethernet MAC address of the peer and establish a PPPoE session ID. Although PPP defines a peer-to-peer relationship, discovery is inherently a client/server relationship. In the discovery process, a host (the client) discovers an access concentrator (the server). Depending on the network topology, there may be more than one access concentrator with which the host can communicate. The Discovery Stage allows the host to discover all access concentrators and then select one. When discovery is completed, both the host and the selected access concentrator have the information they will use to build their point-to-point connection over Ethernet.

PPPoE over ATM Conditions and Restrictions

Note the following conditions and restrictions for PPPoE over ATM:

- PPPoE will not be supported on any other LAN interfaces, such as FDDI and Token Ring.
- Fast switching is supported. PPPoE over ATM forwarding information base (FIB) switching will be supported for IP. All other protocols will be switched over process switching.
- Bridging is supported on the ATM PVCs running PPPoE.
- PPPoE will be supported on ATM PVCs compliant with RFC 1483 only.
- Only dial-in mode will be supported. Dial-out mode will not be supported.
- 2000 simultaneous PPP sessions are supported on the Cisco series 7200 with enhanced ATM port adapters and on the Cisco series 6400 platforms only, both with 128 MB of DRAM.

PPPoE over ATM Configuration Task List

See the following sections for configuration tasks for PPPoE over ATM. Each task in the list indicates if the task is optional or required.

- [Configuring a Virtual Template](#) (Optional, but recommended)
- [Configuring a VPDN Group for PPPoE over ATM](#) (Required)
- [Enabling PPPoE on an ATM PVC or PVC Range](#) (Required)

Configuring a Virtual Template

Prior to configuring the VPDN group and the ATM PVC for PPPoE over ATM, you typically configure a virtual template. To configure a virtual template, see the section “[Creating and Configuring a Virtual Template](#)” earlier in this chapter.



Note

Although Cisco Express Forwarding (CEF) switching is supported by PPPoE over ATM, fast switching, flow, and optimum switching are not; these configurations are ignored on the PPPoE-over-ATM virtual access interface. CEF is enabled by default for IP. All other protocol traffic will be processed switched.

Configuring a VPDN Group for PPPoE over ATM

To configure the physical interface that will carry the PPPoE session and link it to the appropriate virtual template interface, use the following commands beginning in global configuration mode:

	Command	Purpose
Step 1	Router(config)# vpdn enable	Enables virtual private dial-up network (VPDN) configuration on this router.
Step 2	Router(config)# vpdn group <i>name</i>	Associates a VPDN group with a customer or VPDN profile.
Step 3	Router(config-vpdn)# accept dialin	Creates an accept dial-in VPDN group.
Step 4	Router(config-vpdn-acc-in)# protocol pppoe	Specifies the VPDN group to be used to establish PPPoE sessions.
Step 5	Router(config-vpdn-acc-in)# virtual-template <i>template-number</i>	Specifies which virtual template will be used to clone virtual access interfaces.
Step 6	Router(config-vpdn)# pppoe limit per-vc <i>number</i>	Specifies the maximum number of PPPoE sessions to be established over a VC.

Enabling PPPoE on an ATM PVC or PVC Range

To enable PPPoE on an ATM PVC, use the following commands beginning in global configuration mode:

	Command	Purpose
Step 1	Router(config)# interface atm <i>slot/0.subinterface-number</i> multipoint point-to-point or Router(config)# interface atm <i>number.subinterface-number</i> multipoint point-to-point	Specifies the ATM subinterface using the appropriate format of the interface atm command. ¹ A multipoint subinterface is recommended for interface conservation. A point-to-point subinterface will greatly restrict the total number of PPPoE sessions you can have up.
Step 1	Router(config-subif)# pvc [<i>name</i>] <i>vpi/vci</i>	Configures the PVC.
Step 2	Router(config-if-atm-vc)# encapsulation aal5snap	Specifies AAL5 SNAP for ATM encapsulation on the PVC.
Step 3	Router(config-if-atm-vc)# protocol pppoe	Specifies the protocol that the VPDN group will use.

1. Use the **interface atm slot/0** command with the ATM Interface Processor (AIP) on Cisco 7500 series routers, any ATM port adapter on the Cisco 7200 series routers, and the 1-port ATM-25 network module on the Cisco 2600 and 3600 series routers. Use the **interface atm slot/port-adapter/0** command with any ATM port adapter on the Cisco 7500 series routers. Use the **interface atm number** command with the NPM on the Cisco 4500 and 4700 routers. Use **interface atm 0** on the Cisco MC3810.

To enable PPPoE on an ATM PVC range, use the following commands beginning in global configuration mode:

	Command	Purpose
Step 1	<pre>Router(config)# interface atm slot/0.subinterface-number multipoint point-to-point or Router(config)# interface atm number.subinterface-number multipoint point-to-point</pre>	<p>Specifies the ATM subinterface using the appropriate format of the interface atm command.¹</p> <p>A multipoint subinterface is recommended for interface conservation. A point-to-point subinterface will greatly restrict the total number of PPPoE sessions you can have up.</p>
Step 1	<pre>Router(config-subif)# range [range-name] pvc start-vpi/start-vci end-vpi/end-vci</pre>	Configures the PVC range.
Step 2	<pre>Router(config-if-atm-range)# encapsulation aal5snap</pre>	Specifies AAL5 SNAP for ATM encapsulation on the PVC range.
Step 3	<pre>Router(config-if-atm-range)# protocol pppoe</pre>	Specifies the VPDN group to be used for establishing PPPoE sessions on the PVC range.

1. Use the **interface atm slot/0** command with the ATM Interface Processor (AIP) on Cisco 7500 series routers, any ATM port adapter on the Cisco 7200 series routers, and the 1-port ATM-25 network module on the Cisco 2600 and 3600 series routers. Use the **interface atm slot/port-adapter/0** command with any ATM port adapter on the Cisco 7500 series routers. Use the **interface atm number** command with the NPM on the Cisco 4500 and 4700 routers. Use **interface atm 0** on the Cisco MC3810.

Once you configure the router for PPPoE over ATM, the PPP subsystem starts and the router attempts to send a PPP configure request to the remote peer. If the peer does not respond, the router periodically goes into a “listen” state and waits for a configuration request from the peer. After a timeout (typically 45 seconds), the router again attempts to reach the remote router by sending configuration requests.

For more information about configuring an ATM PVC range, see the section “[Configuring an ATM PVC Range](#)” later in this chapter.

For an example of PPPoE over ATM, see the section “[PPPoE over ATM Configuration Example](#)” at the end of this chapter.

Configuring PPPoE over Ethernet

PPPoE over Ethernet enhances PPPoE functionality by adding direct connection to actual Ethernet and FastEthernet interfaces. PPPoE over Ethernet provides service-provider digital subscriber line (DSL) support by enabling multiple hosts on a shared Ethernet interface to open PPP sessions to multiple destinations with one or more bridging modems.



Note

Fast switching is supported. PPPoE FIB switching will be supported for IP. All other protocols will be switched over process switching.

PPPoE over Ethernet Configuration Task List

To configure PPPoE on an Ethernet or FastEthernet interface, perform the tasks in the following sections. Each task is identified as required or optional.

- [Configuring a Virtual Template](#) (Optional, but recommended)
- [Enabling PPPoE on an Ethernet Interface](#) (Required)
- [Configuring PPPoE in a VPDN Group](#) (Required)
- [Verifying PPPoE over Ethernet](#) (Optional)

Configuring a Virtual Template

Prior to configuring the VPDN group and the interface for PPPoE, you typically configure a virtual template. To configure a virtual template, see the section “[Creating and Configuring a Virtual Template](#)” earlier in this chapter.

Enabling PPPoE on an Ethernet Interface

To enable PPPoE on an Ethernet interface, use the following commands beginning in global configuration mode:

	Command	Purpose
Step 1	Router(config)# interface ethernet <i>number</i>	Specifies an Ethernet interface, and enters interface configuration mode.
Step 2	Router(config-subif)# pppoe enable	Enables PPPoE and allows PPPoE sessions to be created through that subinterface.

Configuring PPPoE in a VPDN Group

To configure a VPDN group for PPPoE and to link it to the appropriate virtual template interface, use the following commands beginning in global configuration mode:

	Command	Purpose
Step 1	Router(config)# vpdn enable	Enables virtual private dial-up network (VPDN) configuration on this router.
Step 2	Router(config)# vpdn group <i>name</i>	Associates a VPDN group to a customer or VPDN profile.
Step 3	Router(config-vpdn)# accept dialin	Creates an accept dial-in VPDN group.
Step 4	Router(config-vpdn-acc-in)# protocol pppoe	Specifies the VPDN group to be used to establish PPPoE sessions.
Step 5	Router(config-vpdn-acc-in)# virtual-template <i>template-number</i>	Specifies which virtual template will be used to clone virtual access interfaces.
Step 6	Router(config-vpdn)# pppoe limit per-mac <i>number</i>	Specifies the maximum number of PPPoE sessions that can be sourced from a MAC address.

For an example of PPPoE over Ethernet, see the section “[PPPoE over Ethernet Configuration Example](#)” at the end of this chapter.

Verifying PPPoE over Ethernet

To verify PPPoE over Ethernet, use the following commands in EXEC mode:

Command	Purpose
Router# <code>show vpdn</code>	Displays information about active Level 2 Forwarding (L2F) Protocol tunnel and message identifiers in a VPDN.
Router# <code>show vpdn session packet</code>	Displays PPPoE session statistics.
Router# <code>show vpdn session all</code>	Displays PPPoE session information for each session ID.
Router# <code>show vpdn tunnel</code>	Displays PPPoE session count for the tunnel.

Configuring PPPoE over IEEE 802.1Q VLANs

IEEE 802.1Q encapsulation is used to interconnect a VLAN-capable router with another VLAN-capable networking device. When you configure PPPoE over IEEE 802.1Q VLANs, the packets on the 802.1Q link contain a standard Ethernet frame and the VLAN information associated with that frame.

PPPoE over IEEE 802.1Q VLANs Conditions and Restrictions

- The PPPoE over IEEE 802.1Q VLANs feature is supported on Fast Ethernet. The feature is also supported on 10 Mbps Ethernet when a 4e/8e AMDP2 Ethernet adapter on the Cisco 7200 series router is used.
- Only PPPoE dial-in is supported. PPPoE dial-out (client) will not be supported.
- PPPoE termination and bridging will not work together on the same VLAN.
- PPPoE will be disabled by default on a VLAN.
- The feature is supported on routers running Cisco IOS software. This feature is not supported on Route Switch Modules (RSMs) for Catalyst switches.

PPPoE over IEEE 802.1Q VLANs Configuration Task List

To configure PPPoE over an 802.1Q VLAN, perform the tasks in the following sections. Each task is identified as required or optional.

- [Configuring a Virtual Template](#) (Optional, but recommended)
- [Enabling PPPoE on an Ethernet 802.1Q Interface](#) (Required)
- [Configuring PPPoE in a VPDN Group for an 802.1Q VLAN](#) (Required)
- [Verifying PPPoE over an IEEE 802.1Q VLAN](#) (Optional)

Configuring a Virtual Template

Prior to configuring the VPDN group and the interface for PPPoE over 802.1Q VLANs, you typically configure a virtual template. To configure a virtual template, see the section “Creating and Configuring a Virtual Template” earlier in this chapter.

Enabling PPPoE on an Ethernet 802.1Q Interface

To enable PPPoE on an Ethernet 802.1Q encapsulated subinterface, use the following commands beginning in global configuration mode:

	Command	Purpose
Step 1	Router(config)# interface fastethernet <i>slot/port.subinterface-number</i>	Specifies a Fast Ethernet subinterface and enters subinterface configuration mode.
Step 2	Router(config-subif)# encapsulation dot1q <i>vlan-id</i>	Enables IEEE 802.1Q encapsulation on a specified subinterface in VLANs.
Step 3	Router(config-subif)# pppoe enable	Enables PPPoE and allows PPPoE sessions to be created through the specified subinterface.
Step 4	Router(config-subif)# pppoe max-session <i>number</i>	(Optional) Specifies the maximum number of PPPoE sessions under a VLAN.

Configuring PPPoE in a VPDN Group for an 802.1Q VLAN

To configure a VPDN group for PPPoE and to link it to the appropriate virtual template interface, use the following commands beginning in global configuration mode:

	Command	Purpose
Step 1	Router(config)# vpdn enable	Enables virtual private dialup network (VPDN) configuration on this router.
Step 2	Router(config)# vpdn group <i>name</i>	Associates a VPDN group to a customer or VPDN profile.
Step 3	Router(config-vpdn)# accept dialin	Creates an accept dial-in VPDN group.
Step 4	Router(config-vpdn-acc-in)# protocol pppoe	Specifies the VPDN group to be used to establish PPPoE sessions.
Step 5	Router(config-vpdn-acc-in)# virtual-template <i>template-number</i>	Specifies which virtual template will be used to clone virtual access interfaces.
Step 6	Router(config-vpdn)# pppoe limit per-vlan <i>number</i>	(Optional) Specifies the maximum number of PPPoE sessions under each VLAN.
Step 7	Router(config-vpdn)# pppoe limit per-mac <i>number</i>	(Optional) Specifies the maximum number of PPPoE sessions to be sourced from a MAC address.

Verifying PPPoE over an IEEE 802.1Q VLAN

To verify the configuration of VPDN groups and PPPoE over IEEE 802.1Q VLAN, use either or both of the following EXEC commands:

Command	Purpose
Router# <code>show vpdn session</code>	Displays information about active Layer 2 Tunnel Protocol (L2TP) or Layer 2 Forwarding (L2F) sessions in a VPDN.
Router# <code>show vpdn tunnel</code>	Displays information about active L2TP or L2F tunnels in a VPDN.

Configuring RADIUS Port Identification for PPP

Configuring RADIUS port identification for PPP enables an L2TP access concentrator (LAC) and an L2TP network server (LNS) to identify and forward RADIUS NAS-Port and NAS-Port-Type attribute values for PPP over ATM, PPPoE over ATM, and PPPoE over IEEE 802.1Q VLANs.

RADIUS port identification for PPP requires the PPP extended NAS-Port format. The PPP extended NAS-Port format increases the size of the NAS-Port attribute field to 32 bits and changes the NAS-Port attribute format to provide the RADIUS server with details about the ATM port, the virtual path identifier (VPI), the virtual channel identifier (VCI), and, for IEEE 802.1Q VLANs, the VLAN ID.

For more general information about configuring RADIUS, see the “Configuring RADIUS” chapter in the *Cisco IOS Security Configuration Guide*.

PPP over ATM and PPPoE over ATM Format

For PPP over ATM and PPPoE over ATM, the PPP extended format enables the NAS-Port attribute field to provide details about the ATM interface, VPI, and VCI. [Figure 15](#) shows the format of the NAS-Port attribute field when the PPP extended NAS-Port format is configured and PPP over ATM or PPPoE over ATM is being used.

Figure 15 Format of the NAS-Port Attribute Field for PPP over ATM and PPPoE over ATM

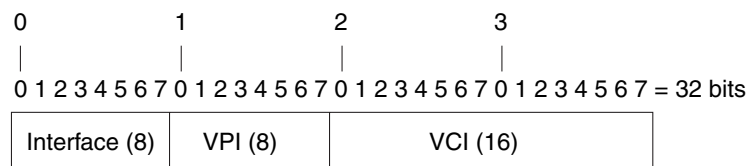

51037

The interface, VPI, and VCI correspond to the interface and virtual circuit (VC) on which the session entered the router. For Cisco 6400 series routers, the interface, VPI, and VCI correspond to the interface and VC on which the session entered the Cisco 6400 node switch processor (NSP).

[Figure 16](#) shows the format of the 8-bit interface field. For platforms that do not have slots or modules, the slot and module fields will be 0.

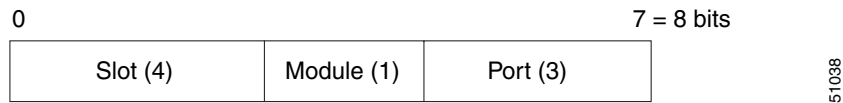
Figure 16 Format of the Interface Field for PPP over ATM and PPPoE over ATM

The NAS-Port-Type value for PPP over ATM and PPPoE over ATM is 5, which is the value for virtual port types.

PPPoE over IEEE 802.1Q VLANs Format

For PPPoE over 802.1Q VLANs, the PPP extended format provides details about the interface and the VLAN ID. [Figure 17](#) shows the format of the NAS-Port attribute field when the PPP extended NAS-Port format is configured and PPPoE over an IEEE 802.1Q VLAN is being used.

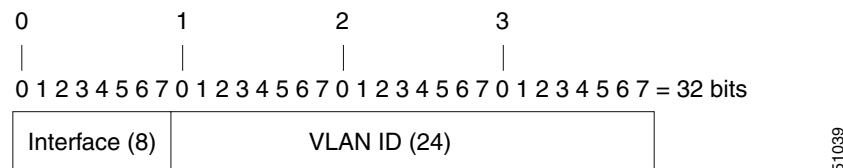
Figure 17 Format of the NAS-Port Attribute Field for PPPoE over 802.1Q VLANs

[Figure 18](#) shows the format of the 8-bit interface field. For platforms that do not have slots or modules, the slot and module fields will be 0.

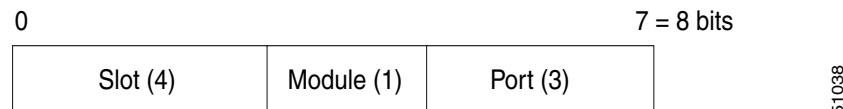
Figure 18 Format of the Interface Field for PPPoE over 802.1Q VLANs

The NAS-Port-Type value for PPPoE over 802.1Q VLANs is 15.

RADIUS Port Identification for PPP Configuration Tasks

See the following sections for configuration tasks for RADIUS port identification for PPP. Each task in the list is identified as optional or required.

- [Configuring the LAC for RADIUS Port Identification for PPP](#) (Required)
- [Configuring the LNS for RADIUS Port Identification for PPP](#) (Required)

Configuring the LAC for RADIUS Port Identification for PPP

To configure the LAC with the NAS-Port format for PPP over ATM, PPPoE over ATM, and PPPoE over 802.1Q VLANs, use the following command in global configuration mode:

Command	Purpose
Router(config)# radius-server attribute nas-port format d	Specifies that PPP extended NAS-Port format will be used for RADIUS accounting.

For examples of RADIUS port identification for PPP configured on an LAC, see the [“RADIUS Port Identification for PPPoE over ATM Example”](#) and the [“RADIUS Port Identification for PPPoE over an 802.1Q VLAN Example”](#) at the end of this chapter.

Configuring the LNS for RADIUS Port Identification for PPP

To configure the LNS to recognize the NAS-Port format for PPP over ATM, PPPoE over ATM, and PPPoE over 802.1Q VLANs, use the following commands in global configuration mode:

	Command	Purpose
Step 1	Router(config)# radius-server attribute nas-port format d	Specifies that PPP extended NAS-Port format will be used for RADIUS accounting.
Step 2	Router(config)# vpdn aaa attribute nas-port vpdn-nas	Enables the LNS to send PPP extended NAS-Port format values to the RADIUS server for accounting.



Note

In order for the LNS to forward PPP extended NAS-Port format values to the RADIUS server, both the LAC and the LNS must be Cisco routers running a Cisco IOS image that supports RADIUS port identification for PPP.

For an example of RADIUS port identification for PPP configured on an LNS, see the section [“Configuring the LNS for RADIUS Port Identification for PPP Example”](#) at the end of this chapter.

Configuring ATM Routed Bridge Encapsulation

ATM routed bridge encapsulation (RBE) is used to route IP over bridged RFC 1483 Ethernet traffic from a stub-bridged LAN.

[Figure 19](#) shows an ATM subinterface on a head-end router that is configured to function in ATM routed-bridge encapsulation mode. This configuration is useful when a remote bridged Ethernet network device needs connectivity to a routed network via a device bridging from an Ethernet LAN to an ATM RFC 1483 bridged encapsulation.

Figure 19 ATM Routed Bridge Encapsulation

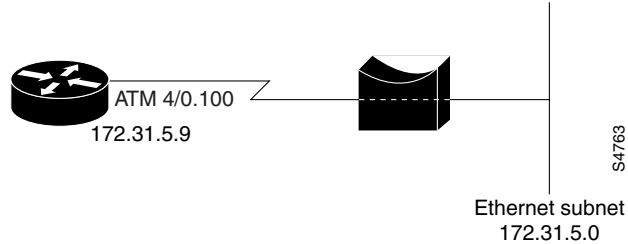

Bridged IP packets received on an ATM interface configured in routed-bridge mode are routed via the IP header. Such interfaces take advantage of the characteristics of a stub LAN topology commonly used for DSL access and offer increased performance and flexibility over integrated routing and bridging (IRB).

Another benefit of ATM RBE is that it reduces the security risk associated with normal bridging or IRB by reducing the size of the nonsecured network. By using a single virtual circuit (VC) allocated to a subnet (which could be as small as a single IP address), ATM RBE uses an IP address in the subnet to limit the “trust environment” to the premises of a single customer.

ATM RBE does not support MAC-layer access lists; only IP access lists are supported.

ATM RBE does support Cisco Express Forwarding (CEF), fast switching, and process switching.

ATM RBE Subinterface Grouping by PVC Range

You can configure ATM routed bridge encapsulation using an ATM PVC range rather than individual PVCs. When you configure a PVC range for routed bridge encapsulation, a point-to-point subinterface is created for each PVC in the range. The number of PVCs in a range can be calculated using the following formula:

$$\text{number of PVCs} = (\text{end-vpi} - \text{start-vpi} + 1) \times (\text{end-vci} - \text{start-vci} + 1)$$

Subinterface numbering begins with the subinterface on which the PVC range is configured and increases sequentially through the range.



Note

You cannot explicitly configure the individual point-to-point subinterfaces created by the PVC range on a point-to-point subinterface. All the point-to-point subinterfaces in the range share the same configuration as the subinterface on which the PVC range is configured.

For further information on PVC ranges, see the section “[Configuring an ATM PVC Range](#),” later in this chapter.

For an example of subinterface grouping by PVC range, see the section “[ATM PVC Range on a Point-to-Point Subinterface Example](#)” at the end of this chapter.

ATM Routed Bridge Encapsulation Configuration Task List

To configure ATM routed bridge encapsulation, perform the tasks in the following section. Each task is identified as required or optional.

- [Configuring ATM Routed Bridge Encapsulation](#) (Required)
- [Verifying ATM Routed Bridge Encapsulation](#) (Optional)

Configuring ATM Routed Bridge Encapsulation

To configure ATM RBE, use the following commands beginning in global configuration mode:

	Command	Purpose
Step 1	Router(config)# interface atm slot/0.subinterface-number point-to-point	Specifies an ATM point-to-point subinterface.
Step 2	Router(config-subif)# pvc VPI/VCI or Router(config-subif)# range [range-name] pvc start-vpi/start-vci end-vpi/end-vci	Configures a PVC to carry the routed bridge traffic. Configures a range of PVCs to carry the routed bridge traffic.
Step 3	Router(config-if-atm-vc)# exit or Router(config-if-atm-range)# exit	Exits to subinterface configuration mode.
Step 4	Router(config-subif)# atm route-bridge ip	Enables the ATM Routed Bridge Encapsulation feature for IP.
Step 5	Router(config-subif)# ip address ip-address mask [secondary]	Provides an IP address on the same subnetwork as the remote network.
Step 6	Router(config-subif)# ^Z	Exits to EXEC mode.

Only the specified network layer (IP) will be routed. Any remaining protocols can be passed on to bridging or other protocols. In this manner, ATM RBE can be used to route IP, while other protocols (such as IPX) are bridged normally.

For examples of ATM RBE, see the section “[ATM Routed Bridge Encapsulation Configuration Examples](#)” at the end of this chapter.

Verifying ATM Routed Bridge Encapsulation

To confirm that ATM RBE is enabled, use the **show arp** command and the **show ip cache verbose** command in EXEC mode:

```
Router# show arp
```

```

Protocol  Address           Age (min)  Hardware Addr  Type   Interface
-----
Internet  10.1.0.51         6          0001.c9f2.a81d  ARPA   Ethernet3/1
Internet  10.1.0.49         -          0060.0939.bb55  ARPA   Ethernet3/1
Internet  10.0.75.1         30         0010.0ba6.2020  ARPA   Ethernet3/0
Internet  10.8.101.35       6          00e0.1e8d.3f90  ARPA   ATM1/0.4
Internet  10.8.100.50       5          0007.144f.5d20  ARPA   ATM1/0.2
Internet  10.0.75.49        -          0060.0939.bb54  ARPA   Ethernet3/0
Internet  10.1.0.125        30         00b0.c2e9.bc55  ARPA   Ethernet3/1#

```

```

Router# show ip cache verbose

IP routing cache 3 entries, 572 bytes
  9 adds, 6 invalidates, 0 refcounts
Minimum invalidation interval 2 seconds, maximum interval 5 seconds,
  quiet interval 3 seconds, threshold 0 requests
Invalidation rate 0 in last second, 0 in last 3 seconds
Last full cache invalidation occurred 00:30:34 ago

Prefix/Length      Age           Interface      Next Hop
10.1.0.51/32-24    00:30:10     Ethernet3/1    10.1.0.51
                  14 0001C9F2A81D00600939BB550800
10.8.100.50/32-24  00:00:04     ATM1/0.2       10.8.100.50
                  28 00010000AAAA030080C2000700000007144F5D2000600939
                  BB1C0800
10.8.101.35/32-24  00:06:09     ATM1/0.4       10.8.101.35
                  28 00020000AAAA030080C20007000000E01E8D3F9000600939
                  BB1C0800

```

Configuring an ATM PVC Range

In a digital subscriber line (DSL) environment, many applications require the configuration of a large number of ATM permanent virtual circuits (PVCs). You can configure the PVCs individually. For detailed information about configuring individual ATM PVCs, see the section “[Configuring PVCs](#)” in the chapter “Configuring ATM” earlier in this book. You can also group a number of PVCs together into a *range* in order to configure them all at once. An ATM PVC range provides the following benefits:

- It saves time because configuring a range of PVCs is faster than configuring a number of PVCs individually.
- It saves NVRAM because a range of PVCs takes up less NVRAM on network service routers than a large number of individually configured PVCs.
- It speeds boot-up time because the parser is able to parse one configuration command instead of many.

A PVC range is defined by two VPI–VCI pairs. The two virtual path identifiers (VPIs) define a VPI range, and the two virtual channel identifiers (VCIs) define a VCI range. The number of PVCs in the PVC range equals the number of VPIs in the VPI range multiplied by the number of VCIs in the VCI range.

For applications that use multipoint subinterfaces, such as PPPoE and PPP over ATM, the PVC range is on a single multipoint subinterface. For applications that use point-to-point subinterfaces, such as routed bridge encapsulation (RBE), a point-to-point subinterface is created for each PVC in the range.

Once you have configured an ATM PVC range, you have the option to explicitly configure individual PVCs within the range by using the **pvc-in-range** command.

To create and configure an ATM PVC range, complete the tasks in the following sections. Each task is identified as optional or required.

- [Creating an ATM PVC Range](#) (Required)
- [Deactivating a PVC Range](#) (Optional)
- [Configuring an Individual PVC Within a PVC Range](#) (Optional)
- [Deactivating an Individual PVC Within a PVC Range](#) (Optional)
- [Verifying an ATM PVC Range](#) (Optional)

Creating an ATM PVC Range

To create an ATM PVC range, use following commands beginning in global configuration mode:

	Command	Purpose
Step 1	Router(config)# interface atm <i>slot/port.subinterface-number</i> { point-to-point multipoint }	Configures an ATM subinterface.
Step 2	Router(config-subif)# range [<i>range-name</i>] pvc <i>start-vpi/start-vci end-vpi/end-vci</i>	Defines a range of PVCs and enables PVC range configuration mode.
Step 3	Router(config-if-atm-range)# exit	Exits PVC range configuration mode.

The number of PVCs in a range can be calculated using the following formula:

$$\text{number of PVCs} = (\text{end-vpi} - \text{start-vpi} + 1) \times (\text{end-vci} - \text{start-vci} + 1).$$

The *start-vpi* argument may be omitted if it is zero. The *end_vpi* argument may be omitted, but if it is omitted, it is assigned the value of *start-vpi*. The *end-vpi* and *end-vci* arguments are always greater than or equal to *start-vpi* and *start-vci*, respectively.

Once the PVC range is defined, you can configure the range by using the configuration commands that are supported in PVC range configuration mode.



Note

For point-to-point subinterfaces, subinterface numbering begins with the subinterface on which the PVC range is configured and increases sequentially through the range.

For an example of ATM PVC range configuration, see the sections “[ATM PVC Range on a Point-to-Point Subinterface Example](#)” and “[ATM PVC Range on a Multipoint Subinterface Example](#)” at the end of this chapter.

Deactivating a PVC Range

To deactivate a PVC range, use the following command in PVC range configuration mode:

Command	Purpose
Router(config-if-atm-range)# shutdown	Deactivates a PVC range.

Configuring an Individual PVC Within a PVC Range

To configure an individual PVC within a PVC range on a multipoint subinterface, use the following commands beginning in global configuration mode:

	Command	Purpose
Step 1	Router(config)# interface atm <i>slot/port.subinterface-number multipoint</i>	Configures an ATM interface.
Step 2	Router(config-subif)# range [<i>range-name</i>] pvc <i>start-vpi/start-vci end-vpi/end-vci</i>	Defines a range of PVCs and enables PVC range configuration mode.
Step 3	Router(config-if-atm-range)# pvc-in-range [<i>pvc-name</i>] [[<i>vpi/vci</i>]	Defines an individual PVC within a PVC range, and enables PVC-in-range configuration mode.
Step 4	Router(cfg-if-atm-range-pvc)# exit	Exits PVC-in-range configuration mode.



Note

You cannot explicitly configure the individual point-to-point subinterfaces created by the PVC range on a point-to-point subinterface. All of the point-to-point subinterfaces in the range share the same configuration as the subinterface on which the PVC range is configured.

For an example of configuring an individual PVC within an ATM PVC range, see the section [“Individual PVC Within a PVC Range Configuration Example”](#) at the end of this chapter.

Deactivating an Individual PVC Within a PVC Range

To deactivate an individual PVC within a range, use the following command in PVC-in-range configuration mode:

Command	Purpose
Router(cfg-if-atm-range-pvc)# shutdown	Deactivates an individual PVC within a range.

Verifying an ATM PVC Range

To verify ATM PVC range configuration, use the following EXEC command:

Command	Purpose
Router# show atm pvc [<i>vpi/vci</i> <i>name</i> interface atm <i>interface-number</i>]	Displays ATM PVCs and traffic information.

Configuration Examples

The examples in the following sections illustrate how to configure the features described in this chapter. The examples are presented in the same order as the corresponding configuration task sections presented earlier in this chapter:

- [PPP over ATM Configuration Examples](#)
- [PPPoE over ATM Configuration Example](#)
- [PPPoE over Ethernet Configuration Example](#)
- [PPPoE over an IEEE 802.1Q VLAN Configuration Example](#)
- [RADIUS Port Identification for PPP Configuration Examples](#)
- [ATM Routed Bridge Encapsulation Configuration Examples](#)
- [ATM PVC Range Configuration Examples](#)

PPP over ATM Configuration Examples

This sections provides the following sets of examples for configuring PPP over ATM:

- [IETF-Compliant MUX Encapsulated PPP over ATM Configuration Examples](#)
- [IETF-Compliant LLC Encapsulated PPP over ATM Configuration Examples](#)
- [Cisco Proprietary PPP-over-ATM Example](#)
- [PPP over an ATM SVC Configuration Example](#)

IETF-Compliant MUX Encapsulated PPP over ATM Configuration Examples

This section provides the following examples for configuring IETF-compliant PPP over ATM:

- [IETF-Compliant PPP over ATM with Different Traffic-Shaping Parameters Example](#)
- [ADSL Termination Example](#)
- [Two Routers with Back-to-Back PVCs Example](#)
- [Multiplexed Encapsulation Using VC Class Example](#)

IETF-Compliant PPP over ATM with Different Traffic-Shaping Parameters Example

PVCs with different PPP-over-ATM traffic-shaping parameters can be configured on the same subinterface. In the following example, three PVCs are configured for PPP over ATM on subinterface ATM 2/0.1. PVC 0/60 is configured with IETF-Compliant PPP over ATM encapsulation. Its traffic-shaping parameter is an unspecified bit rate with peak cell rate at 500 kbps. PVC 0/70 is also configured with IETF-Compliant PPP over ATM encapsulation, but its traffic-shaping parameter is non-real-time variable bit rate, with peak cell rate at 1 Mbps, sustainable cell rate at 500 kbps, and burst cell size of 64 cells. PVC 0/80 is configured with the Cisco-proprietary PPP over ATM encapsulation. Its traffic shaping parameter is an unspecified bit rate with peak cell rate at 700 kbps. For further information, refer to the section “[Configuring IETF-Compliant MUX Encapsulated PPP over ATM PVCs](#)” earlier in this chapter.

```
Router(config)# interface atm 2/0.1 multipoint
Router(config-if)# pvc 0/60
Router(config-if-atm-vc)# encapsulation aal5mux ppp virtual-template 3
Router(config-if-atm-vc)#ubr 500
```

```

Router(config-if-atm-vc) # exit

Router(config-if)# pvc 0/70
Router(config-if-atm-vc) # encapsulation aal5mux ppp virtual-template 3
Router(config-if-atm-vc) # vbr-nrt 1000 500 64
Router(config-if-atm-vc) # exit

Router(config-if)# pvc 0/80
Router(config-if-atm-vc) # encapsulation aal5cisco ppp virtual-template 3
Router(config-if-atm-vc) #ubr 700
Router(config-if-atm-vc) # exit
Router(config-if)#

```

ADSL Termination Example

The IETF-Compliant PPP over ATM feature was designed to support installations with ADSL circuits. [Figure 20](#) illustrates a topology for ADSL termination. This topology allows you to establish a PPP connection to a Cisco 7200 series router.

The example also illustrates the use of PPP tunneling using L2TP to provide VPDN services, in this case for the domain cisco.com. Thus, a user who logs in as bob@cisco.com is automatically tunneled to IP address 10.1.2.3. (See the chapter “Configuring Virtual Private Networks” in the *Cisco IOS Dial Technologies Configuration Guides* for details about setting up VPDN services.)

An example of the commands that you might enter for the user_router, dsl7200, and cisco-gateway (as shown in [Figure 20](#)) are described below. For further information, refer to the section “Configuring IETF-Compliant MUX Encapsulated PPP over ATM PVCs” earlier in this chapter.

Figure 20 ADSL Termination

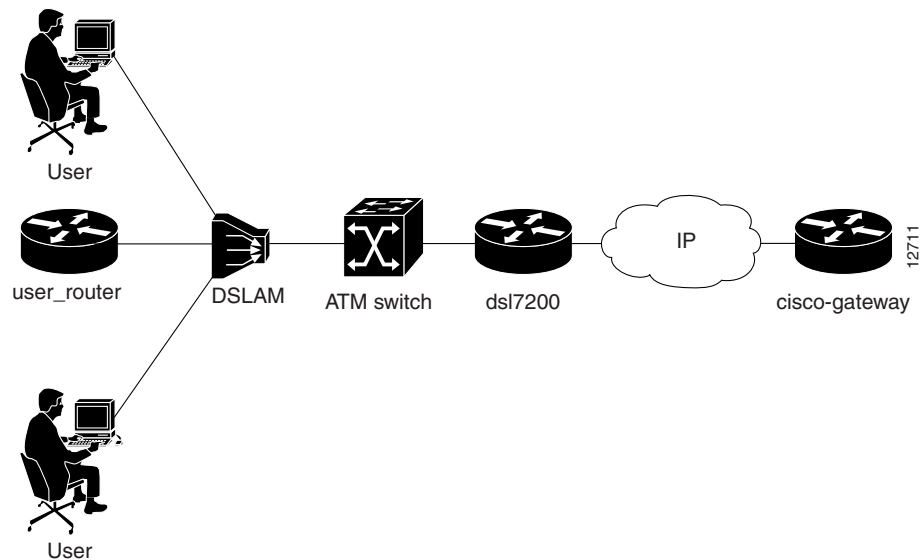

user_router Configuration

```

user_router(config)# interface virtual-template 1
user_router(config-if)# ip address negotiated
user_router(config-if)# ppp chap hostname user_router@cisco.com
user_router(config-if)# ppp chap password 0 cisco
user_router(config-if)# exit

```

```

user_router(config)# interface atm 0
user_router(config-if)# pvc 0/40
user_router(config-if-atm-vc)# encapsulation aal5mux ppp virtual-template 1
user_router(config-if-atm-vc)# exit
user_router(config-if)# exit
user_router(config)#

```

dsl7200 Configuration

```

dsl7200(config)# username user_router@cisco.com password 0 cisco
dsl7200(config)# username dsl7200 password 0 cisco

dsl7200(config)# vpdn enable

dsl7200(config)# vpdn-group 1
dsl7200(config)# request dialin l2tp ip 10.2.1.1 domain cisco.com

dsl7200(config)# interface virtual-template 1
dsl7200(config-if)# ppp authentication chap
dsl7200(config-if)# exit

dsl7200(config)# interface atm 2/0
dsl7200(config-if)# pvc 0/40
dsl7200(config-if-atm-vc)# encapsulation aal5mux ppp virtual-template 1
dsl7200(config-if-atm-vc)# exit
dsl7200(config-if)# exit
dsl7200(config)#

```

cisco-gateway Configuration

```

cisco_gateway(config)# username cisco_gateway password 0 cisco
cisco_gateway(config)# username user_router@cisco.com password 0 cisco

cisco_gateway(config)# vpdn enable

cisco_gateway(config)# vpdn-group 1
cisco_gateway(config)# accept dialin l2tp virtual-template 1 remote dsl7200

cisco_gateway(config)# interface loopback 0
cisco_gateway(config-if)# ip address 10.0.1.1 255.255.255.0
cisco_gateway(config-if)# exit

cisco_gateway(config)# interface virtual-template 1
cisco_gateway(config-if)# ip unnumbered loopback 0
cisco_gateway(config-if)# peer default ip address pool pool-1
cisco_gateway(config-if)# exit

cisco_gateway(config)# ip local pool pool-1 10.1.2.1 10.1.2.254

```

Two Routers with Back-to-Back PVCs Example

Figure 21 illustrates an ATM interface with two PPP sessions over two PVC session connections. (See the chapter “PPP Configuration” in the *Cisco IOS Dial Technologies Configuration Guide* for details on PPP configuration.) The sample commands following Figure 21 establish the back-to-back router configuration. For further information, refer to the section “Configuring IETF-Compliant MUX Encapsulated PPP over ATM PVCs” earlier in this chapter.

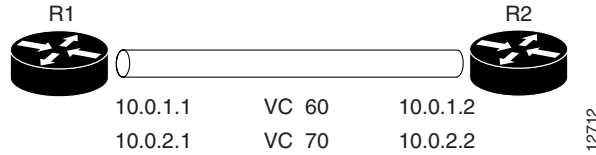
Figure 21 Two Routers with Back-to-Back PVCs**R1 Configuration**

```

Router1(config)# interface atm 2/0
Router1(config-if)# atm clock internal
Router1(config-if)# pvc 0/60
Router1(config-if-atm-vc)# encapsulation aal5mux ppp virtual-template 1
Router1(config-if-atm-vc)#ubr 90
Router1(config-if-atm-vc)# exit

Router1(config-if)# pvc 0/70
Router1(config-if-atm-vc)# encapsulation aal5mux ppp virtual-template 2
Router1(config-if-atm-vc)# vbr-nrt 90 50 1024
Router1(config-if-atm-vc)# exit

Router1(config-if)# interface virtual-template 1
Router1(config-if)# ip address 10.0.1.1 255.255.255.0

Router1(config-if)# interface virtual-template 2
Router1(config-if)# ip address 10.0.2.1 255.255.255.0
Router1(config-if)# exit
Router1(config)#

```

R2 Configuration

```

Router2(config)# interface atm 2/0.1 multipoint
Router2(config-if)# pvc 0/60
Router2(config-if-atm-vc)# encapsulation aal5mux ppp virtual-template 1
Router2(config-if-atm-vc)#ubr 90
Router2(config-if-atm-vc)# exit

Router2(config-if)# pvc 0/70
Router2(config-if-atm-vc)# encapsulation aal5mux ppp virtual-template 2
Router2(config-if-atm-vc)# vbr-nrt 90 50 1024
Router2(config-if-atm-vc)# exit
Router2(config-if)# exit

Router2(config)# interface virtual-template 1
Router2(config-if)# ip address 10.0.1.2 255.255.255.0
Router2(config-if)# exit

Router2(config)# interface virtual-template 2
Router2(config-if)# ip address 10.0.2.2 255.255.255.0

```

Multiplexed Encapsulation Using VC Class Example

In the following example, PVC 0/60 is configured on subinterface ATM 2/0.1 with a VC class attached to it. For details on creating and applying a VC class, see the section “[Configuring VC Classes](#)” in the chapter “Configuring ATM.” By rule of inheritance, PVC 0/60 runs with IETF-Compliant PPP over ATM encapsulation using the configuration from interface virtual-template 1. Its parameter is an unspecified bit rate with peak cell at 90 kbps.

```

Router(config)# interface atm 2/0.1
Router(config-if)# pvc 0/60

```

```

Router(config-if-atm-vc)# class-vc pvc-ppp
Router(config-if-atm-vc)# exit
Router(config-if)# exit

Router(config)# vc-class atm pvc-ppp
Router(config-vc-class)# encapsulation aal5mux ppp virtual-template 1
Router(config-vc-class)# ubr 90
Router(config-vc-class)# exit
Router(config)#

```

IETF-Compliant LLC Encapsulated PPP over ATM Configuration Examples

This section provides the following examples for configuring IETF-compliant LLC encapsulated PPP over ATM:

- [Configuring IETF-Compliant PPP over ATM LLC Encapsulation Example](#)
- [Overriding a Virtual Template for IETF-Compliant PPP over ATM Example](#)
- [Disabling IETF-Compliant PPP over ATM LLC Encapsulation on a Specific VC Example](#)

Configuring IETF-Compliant PPP over ATM LLC Encapsulation Example

This example shows how to configure IETF PPP over ATM LLC Encapsulation in the VC class called “ppp-default.” The VC class specifies virtual template 1 from which to spawn PPP interfaces, snap encapsulation (the default), and a UBR class traffic type at 256 kbps. When the VC class “ppp-default” is configured on interface 0.1, PVC 0/70 inherits these properties. PVC 0/80 overrides virtual template 1 in the VC class and uses virtual template 2 instead. PVC 0/90 also overrides virtual template 1 and uses virtual template 3 instead. In addition, PVC 0/90 uses a VC multiplexed encapsulation and a UBR class traffic type at 500 kbps. For further information, refer to the section “[Configuring IETF-Compliant LLC Encapsulated PPP over ATM PVCs](#)” earlier in this chapter.

```

Router(config)# interface atm 0.1 multipoint
Router(config-if)# class-int ppp-default
!
Router(config-if)# pvc 0/70
Router(config-if-atm-vc)# exit
!
Router(config-if)# pvc 0/80
Router(config-if-atm-vc)# protocol ppp virtual-template 2
Router(config-if-atm-vc)# exit
!
Router(config-if)# pvc 0/90
Router(config-if-atm-vc)# encapsulation aal5mux ppp virtual-template 3
Router(config-if-atm-vc)# ubr 500
Router(config-if-atm-vc)# exit
Router(config-if)# exit
!
Router(config)# vc-class atm ppp-default
Router(config-vc-class)# protocol ppp virtual-template 1
Router(config-vc-class)# ubr 256
Router(config-vc-class)# exit
Router(config)#

```

Overriding a Virtual Template for IETF-Compliant PPP over ATM Example

This example illustrates how to use inheritance to override a virtual template configuration for **mux ppp** or **cisco-ppp** encapsulation options. For PVC 5/505, since the encapsulation option at that level is **cisco-ppp** virtual template 1, as specified in the VC class called “muxppp,” the **protocol ppp**

virtual-template 2 command overrides only the virtual-template configuration. For further information, refer to the section “[Configuring IETF-Compliant LLC Encapsulated PPP over ATM PVCs](#)” earlier in this chapter.

```
Router(config)# interface atm 2/0
Router(config-if)# class-int muxppp
!
Router(config-if)# pvc 5/505
Router(config-if-atm-vc)# protocol ppp virtual-template 2
Router(config-if-atm-vc)# exit
!
Router(config)# vc-class muxppp
Router(config-vc-class)# encapsulation aal5cisco ppp virtual-template 1
Router(config-vc-class)# exit
Router(config)#
```

Disabling IETF-Compliant PPP over ATM LLC Encapsulation on a Specific VC Example

This example shows how to limit the configuration of a particular LLC encapsulated protocol to a particular VC. First, we see that the VC class called “ppp” is configured with IETF PPP over ATM with LLC encapsulation and virtual template 1. This VC class is then applied to ATM interface 1/0/0. By configuring **snap** encapsulation by itself on PVC 0/32, you disable IETF PPP over ATM with LLC encapsulation on this particular PVC; PVC 0/32 will only carry IP. For further information, refer to the section “[Configuring IETF-Compliant LLC Encapsulated PPP over ATM PVCs](#)” earlier in this chapter.

```
Router(config)# interface atm 1/0/0
Router(config-if)# class-int ppp
Router(config-if)# exit
!
Router(config)# interface atm 1/0/0.100 point-to-point
Router(config-if)# description IP only VC
Router(config-if)# ip address 10.1.1.1 255.255.255.0
Router(config-if)# pvc 0/32
Router(config-if-atm-vc)# encapsulation aal5snap
Router(config-if-atm-vc)# exit
Router(config-if)# exit
!
Router(config)# vc-class atm ppp
Router(config-vc-class)# encapsulation aal5snap
Router(config-vc-class)# protocol ppp virtual-template 1
Router(config-vc-class)# exit
Router(config)#
```

Cisco Proprietary PPP-over-ATM Example

The following example shows how to configure Cisco Proprietary PPP over ATM to use PPP unnumbered link and Challenge Handshake Authentication Protocol (CHAP) authentication. For further information, refer to the sections “[Configuring PPP over ATM](#)” and “[Configuring Cisco-Proprietary PPP over ATM PVCs](#)” earlier in this chapter.

```
configure terminal
!
interface virtual-template 2
 encapsulation ppp
 ip unnumbered ethernet 0/0
 ppp authentication chap
!
interface atm 2/0.2 point-to-point
 pvc 0/34
 encapsulation aal5cisco ppp virtual-template 2
 exit
```

PPP over an ATM SVC Configuration Example

In the following example, ATM interface 2/0/0 is configured to accept ATM SVC calls whose called party address is 47.00918100000000400B0A2501.0060837B4740.00. The same ATM NSAP address can be configured on other physical ATM interfaces as well. When a PPP session is established, a virtual access interface is created and cloned with the configuration from virtual template 1. All PPP sessions established on this ATM interface will use the IP address of loopback interface 0. A maximum of 100 SVCs can be established using this configuration. SVCs established using this configuration cannot take up more than 50 Mbps in total bandwidth.

```
interface ATM 2/0/0
  svc anna
  encapsulation aal5auto
  protocol ppp virtual-template 1
  max vc 100
  max bandwidth 50000
  atm nsap 47.00918100000000400B0A2501.0060837B4740.00
!
interface virtual-template 1
  ip unnumbered loopback 0
!
interface loopback 0
  ip address 10.7.1.1 255.255.255.0
```

PPPoE over ATM Configuration Example

The following example configures PPPoE over ATM to accept dial-in PPPoE sessions. The virtual access interface for the PPP session is cloned from virtual template interface 1. On subinterface ATM 2/0.1, ATM PVC with VPI 0 and VCI 60 is configured with Logical Link Control (LLC)/Subnetwork Access Protocol (SNAP) encapsulation and is configured to run PPPoE. Bridged Ethernet protocol data units (PDUs) with destination MAC address set to the ATM interface MAC address and Ethernet type set to 0x8863 for that PVC are enqueued to the PPPoE discovery process. All bridged Ethernet PDUs with destination MAC address set to the ATM interface MAC address and Ethernet type set to 0x8864 coming in from that PVC are forwarded to the virtual access interface associated with the PPP session.

```
vpdn enable

vpdn-group 1
  accept dialin
  protocol pppoe
  virtual-template 1

interface atm 2/0.1 multipoint
  pvc 0/60
  encapsulation aal5snap
  protocol pppoe

interface virtual-template 1
  ip addr 10.0.1.2 255.255.255.0
  mtu 1492
```

For PPPoE virtual template interfaces, “mtu 1492” must be configured because Ethernet has a maximum payload size of 1500 bytes, the PPPoE header is 6 bytes, and PPP Protocol ID is 2 bytes.



Note

Dial-out mode will not be supported.

PPPoE over Ethernet Configuration Example

The following example configures PPPoE on Ethernet to accept dial-in PPPoE sessions. The virtual access interface for the PPP session is cloned from virtual template interface 1. Bridged Ethernet protocol data units (PDUs) with destination MAC addresses set to the Ethernet interface MAC address and Ethernet type set to 0x8863 are enqueued to the PPPoE discovery process. All bridged Ethernet PDUs with destination MAC addresses set to the Ethernet interface MAC address and Ethernet type set to 0x8864 coming in are forwarded to the virtual access interface associated with the PPP session.

```
interface ethernet1/0
  pppoe enable
  !
  vpdn enable
  !
  vpdn-group 1
    accept dialin
    protocol pppoe
    virtual template 1
  pppoe limit per-mac 90
  !
interface virtual-template 1
  ip address 100.100.100.100 255.255.255.0
  mtu 1492
```

For PPPoE virtual template interfaces, the **mtu** command must be configured because Ethernet has a maximum payload size of 1500 bytes, the PPPoE header is 6 bytes, and PPP Protocol ID is 2 bytes.



Note

Dial-out mode will not be supported.

PPPoE over an IEEE 802.1Q VLAN Configuration Example

The following example shows the configuration of PPPoE over an 802.1Q encapsulated VLAN:

```
interface FastEthernet0/0.10
  encapsulation dot1Q 10
  pppoe enable
  !
  vpdn enable
  no vpdn logging
  !
  vpdn-group 1
    accept dialin
    protocol pppoe
    virtual-template 1
  pppoe limit per-vlan 200
  !
interface virtual-template 1
  ip address 100.100.100.100 255.255.255.0
  mtu 1492
```

RADIUS Port Identification for PPP Configuration Examples

This section provides the following examples of RADIUS port identification for PPP:

- [RADIUS Port Identification for PPPoE over ATM Example](#)
- [RADIUS Port Identification for PPPoE over an 802.1Q VLAN Example](#)
- [Configuring the LNS for RADIUS Port Identification for PPP Example](#)

RADIUS Port Identification for PPPoE over ATM Example

The following example shows the configuration of the PPP extended NAS-Port format on an LAC using PPPoE over ATM:

```
!  
vpdn enable  
no vpdn logging  
!  
vpdn-group pppoe  
  accept-dialin  
  protocol pppoe  
  virtual-template 2  
  pppoe limit per-mac 2000  
!  
!  
vpdn-group 2  
  request-dialin  
  protocol l2tp  
  domain testdomain.com  
  initiate-to ip 172.73.0.1  
  local name lac1  
!  
!  
interface ATM4/0.1 multipoint  
  pvc 1/33  
  encapsulation aal5snap  
  protocol pppoe  
end  
!  
aaa new-model  
aaa authentication ppp default local group radius  
aaa authorization network default local group radius  
aaa accounting network default start-stop group radius  
  
radius-server host 171.69.69.66 auth-port 1645 acct-port 1646  
radius-server retransmit 3  
radius-server attribute nas-port format d  
radius-server key rad123  
!
```

RADIUS Port Identification for PPPoE over an 802.1Q VLAN Example

The following example shows the configuration of the PPP extended NAS-Port format on an LAC running PPPoE over an 802.1Q VLAN:

```
!  
vpdn enable  
no vpdn logging  
!  
vpdn-group pppoe
```

```

accept-dialin
  protocol pppoe
  virtual-template 2
pppoe limit per-mac 2
pppoe limit per-vlan 10
!
vpdn-group 2
  request-dialin
  protocol l2tp
  domain testdomain.com
  initiate-to ip 172.73.0.1
  local name lac1
!
interface FastEthernet2/0.2
  encapsulation dot1Q 2
  pppoe enable
!
interface FastEthernet2/0.3
  encapsulation dot1Q 3
  pppoe enable
!
aaa new-model
aaa authentication ppp default local group radius
aaa authorization network default local group radius
aaa accounting network default start-stop group radius

radius-server host 171.69.69.66 auth-port 1645 acct-port 1646
radius-server retransmit 3
radius-server attribute nas-port format d
radius-server key rad123

```

Configuring the LNS for RADIUS Port Identification for PPP Example

In the following example, the LNS is configured to recognize and forward PPP extended NAS-Port format values to the RADIUS server. The PPP extended NAS-Port format must also be configured on the LAC for this configuration to be effective.

```

vpdn enable
no vpdn logging
!
vpdn-group L2TP-tunnel
  accept-dialin
  protocol l2tp
  virtual-template 1
  terminate-from hostname lac1
  local name lns1
!
!
aaa new-model
aaa authentication ppp default local group radius
aaa authorization network default local group radius
aaa accounting network default start-stop group radius

radius-server host 171.79.79.76 auth-port 1645 acct-port 1646
radius-server retransmit 3
radius-server attribute nas-port format d
radius-server key lns123
!
vpdn aaa attribute nas-port vpdn-nas

```

ATM Routed Bridge Encapsulation Configuration Examples

This section provides the following configuration examples:

- [ATM Routed Bridge Encapsulation Example](#)
- [ATM Routed Bridge Encapsulation on an Unnumbered Interface Example](#)
- [Concurrent Bridging and ATM Routed Bridge Encapsulation Example](#)

ATM Routed Bridge Encapsulation Example

The following example shows a typical ATM routed bridge encapsulation configuration:

```
interface atm 4/0.100 point-to-point
 ip address 172.16.5.9 255.255.255.0
 pvc 0/32
  atm route-bridge ip
```

ATM Routed Bridge Encapsulation on an Unnumbered Interface Example

The following example uses a static route to point to an unnumbered interface:

```
interface loopback 0
 ip address 172.16.5.1 255.255.255.0

interface atm 4/0.100 point-to-point
 ip unnumbered loopback 0
 pvc 0/32
  atm route-bridge ip
!
ip route 172.16.5.2 255.255.255.255 atm 4/0.100
```

Concurrent Bridging and ATM Routed Bridge Encapsulation Example

The following example shows concurrent use of ATM routed bridge encapsulation with normal bridging. IP datagrams are route-bridged, and other protocols (such as IPX or AppleTalk) are bridged.

```
bridge 1 protocol ieee

interface atm 4/0.100 point-to-point
 ip address 172.16.5.9 255.255.255.0
 pvc 0/32
  bridge-group 1
  atm route-bridge ip
```

ATM PVC Range Configuration Examples

This section provides the following examples of ATM PVC Range configuration:

- [ATM PVC Range on a Point-to-Point Subinterface Example](#)
- [ATM PVC Range on a Multipoint Subinterface Example](#)
- [Individual PVC Within a PVC Range Configuration Example](#)

ATM PVC Range on a Point-to-Point Subinterface Example

In the following example, a PVC range called “range1” is created with a total of 100 PVCs in the range. A point-to-point subinterface will be created for each PVC in the range. Routed bridge encapsulation is configured on this range.

```
Router(config)# interface atm 6/0.200 point-to-point
Router(config-subif)# ip unnumbered loopback 1
Router(config-subif)# atm route-bridged ip
Router(config-subif)# range range1 pvc 1/200 1/299
Router(config-if-atm-range)# end
```

ATM PVC Range on a Multipoint Subinterface Example

In the following example, a PVC range called “range-pppoa-1” is created with a total of 500 PVCs in the range. PVC parameters are configured for the range, including the assignment of a VC class called “classA.”

```
router(config)# interface atm 6/0.110 multipoint
router(config-subif)# range range-pppoa-1 pvc 100 4/199
router(config-if-atm-range)# class-range classA
router(config-if-atm-range)# ubr 1000
router(config-if-atm-range)# encapsulation aal5snap
router(config-if-atm-range)# protocol ppp virtual-template 2
```

Individual PVC Within a PVC Range Configuration Example

In the following example, “pvc1” within the PVC range called “range1” is deactivated.

```
router(config)# interface atm 6/0.110 multipoint
router(config-subif)# range range1 pvc 100 4/199
router(config-if-atm-range)# class-range classA
router(config-if-atm-range)# pvc-in-range pvc1 3/104
router(cfg-if-atm-range-pvc)# shutdown
```