



Configuring Source-Route Bridging

This chapter describes source-route bridging (SRB) configuration tasks. For a discussion of remote source-route bridging (RSRB) configuration tasks, refer to the “Configuring Remote Source-Route Bridging” chapter in this publication.

For a complete description of the SRB commands mentioned in this chapter, refer to the “Source-Route Bridging Commands” chapter in the *Cisco IOS Bridging and IBM Networking Command Reference* (Volume 1 of 2). To locate documentation of other commands that appear in this chapter, use the command reference master index or search online.

This chapter contains the following sections:

- [Technology Overview, page 83](#)
- [SRB Configuration Task List, page 85](#)
- [Tuning the SRB Network Task List, page 116](#)
- [Monitoring and Maintaining the SRB Network, page 120](#)
- [SRB Configuration Examples, page 121](#)

To identify the hardware platform or software image information associated with a feature, use the Feature Navigator on Cisco.com to search for information about the feature or refer to the software release notes for a specific release. For more information, see the “[Identifying Platform Support for Cisco IOS Software Features](#)” section on [page li](#) in the “Using Cisco IOS Software” chapter.

Technology Overview

Cisco’s IOS bridging software includes SRB capability. A source-route bridge connects multiple physical Token Rings into one logical network segment. If the network segment bridges only Token Ring media to provide connectivity, the technology is termed SRB. If the network bridges Token Ring and non-Token Ring media is introduced into the bridged network segment, the technology is termed RSRB.

SRB enables routers to simultaneously act as a Level 3 router and a Level 2 source-route bridge. Thus, protocols such as Novell’s IPX or XNS can be routed on Token Rings, while other protocols such as Systems Network Architecture (SNA) or NetBIOS are source-route bridged.

SRB technology is a combination of bridging and routing functions. A source-route bridge can make routing decisions based on the contents of the MAC frame header. Keeping the routing function at the MAC, or Level 2, layer allows the higher-layer protocols to execute their tasks more efficiently and allows the LAN to be expanded without the knowledge of the higher-layer protocols.

As designed by IBM and the IEEE 802.5 committee, source-route bridges connect extended Token Ring LANs. A source-route bridge uses the RIF in the IEEE 802.5 MAC header of a datagram (Figure 22) to determine which rings or Token Ring network segments the packet must transit.

Figure 22 IEEE 802.5 Token Ring Frame Format

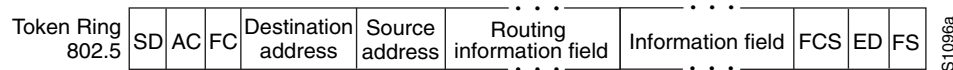

The source station inserts the RIF into the MAC header immediately following the source address field in every frame, giving this style of bridging its name. The destination station reverses the routing field to reach the originating station.

The information in a RIF is derived from explorer packets generated by the source node. These explorer packets traverse the entire source-route bridge network, gathering information on the possible paths the source node might use to send packets to the destination.

Transparent spanning-tree bridging requires time to recompute a topology in the event of a failure; SRB, which maintains multiple paths, allows fast selection of alternate routes in the event of failure. Most importantly, SRB allows the end stations to determine the routes the frames take.

SRB Features

Cisco's SRB implementation has the following features:

- Provides configurable fast-switching software for SRB.
- Provides for a local source-route bridge that connects two or more Token Ring networks.
- Provides *ring groups* to configure a source-route bridge with more than two network interfaces. A ring group is a collection of Token Ring interfaces in one or more routers that are collectively treated as a *virtual ring*.
- Provides two types of explorer packets to collect RIF information—an *all-routes* explorer packet, which follows all possible paths to a destination ring, and a *spanning-tree* explorer packet, which follows a statically configured limited route (spanning tree) when looking for paths.
- Provides a dynamically determined RIF cache based on the protocol. The software also allows you to add entries manually to the RIF cache.
- Provides for filtering by MAC address, link service access point (LSAP) header, and protocol type.
- Provides for filtering of NetBIOS frames either by station name or by a packet byte offset.
- Provides for translation into transparently bridged frames to allow source-route stations to communicate with nonsource-route stations (typically on Ethernet).
- Provides support for the SRB MIB variables as described in the IETF draft "Bridge MIB" document, "Definition of Managed Objects for Bridges," by E. Decker, P. Langille, A. Rijsinghani, and K. McCloghrie, June 1991. Only the SRB component of the Bridge MIB is supported.
- Provides support for the Token Ring MIB variables as described in RFC 1231, *IEEE 802.5 Token Ring MIB*, by K. McCloghrie, R. Fox, and E. Decker, May 1991. Cisco implements the mandatory tables (Interface Table and Statistics Table), but not the optional table (Timer Table) of the Token Ring MIB. The Token Ring MIB has been implemented for the 4/16-Mb Token Ring cards that can be user adjusted for either 4- or 16-Mb transmission speeds (CSC-1R, CSC-2R, CSC-R16M, or CSC-C2CTR).

- SRB is supported over FDDI on Cisco 7200 series routers.
- Particle-based switching is supported (over FDDI and Token Ring) by default on Cisco 7200 series routers.
- Complies with RFC 1483 in Cisco IOS Release 12.0(3)T and later by offering the ability to encapsulate SRB traffic using RFC 1483 bridged LLC encapsulation. This support enables SRB over ATM functionality that is interoperable with other vendors' implementations of SRB over ATM.

SRB Configuration Task List

Perform the tasks in the following sections to configure SRB:

- [Configuring Source-Route Bridging, page 85](#)
- [Configuring Bridging of Routed Protocols, page 92](#)
- [Configuring Translation Between SRB and Transparent Bridging Environments, page 94](#)
- [Configuring NetBIOS Support, page 98](#)
- [Configuring LNM Support, page 102](#)
- [Configuring ATM Support, page 108](#)
- [Securing the SRB Network, page 109](#)
- [Tuning the SRB Network Task List, page 116](#)
- [Establishing SRB Interoperability with Specific Token Ring Implementations, page 120](#)

See the “SRB Configuration Examples” section on page 121 for examples.



Caution

The Cisco IOS software issues a warning if a duplicate bridge definition exists in a router. You must remove an old bridge definition before adding a new bridge definition.

Configuring Source-Route Bridging

The Cisco implementation of source-route bridging enables you to connect two or more Token Ring networks using either Token Ring or Fiber Distributed Data Interface (FDDI) media. You can encapsulate source-route bridging traffic over Frame Relay using RFC 1490 Bridged 802.5 encapsulation.

You can configure the Cisco IOS software for source-route bridging by performing the tasks in one of the first three sections and, optionally, the tasks in the last section:

- [Configuring a Dual-Port Bridge, page 86](#)
- [Configuring a Multiport Bridge Using a Virtual Ring, page 87](#)
- [Configuring SRB over FDDI, page 88](#)
- [Configuring Fast-Switching SRB over FDDI, page 89](#)
- [Configuring SRB over Frame Relay, page 90](#)
- [Enabling the Forwarding and Blocking of Spanning-Tree Explorers, page 90](#)
- [Enabling the Automatic Spanning-Tree Function, page 91](#)
- [Limiting the Maximum SRB Hops, page 92](#)

Configuring a Dual-Port Bridge

A dual-port bridge is the simplest source-route bridging configuration. When configured as a dual-port bridge, the access server or router serves to connect two Token Ring LANs. One LAN is connected through one port (Token Ring interface), and the other LAN is connected through the other port (also a Token Ring interface). [Figure 23](#) shows a dual-port bridge.

Figure 23 Dual-Port Bridge



To configure a dual-port bridge that connects two Token Rings, you must enable source-route bridging on each of the Token Ring interfaces that connect to the two Token Rings. To enable source-route bridging, use the following command in interface configuration mode for each of the Token Ring interfaces:

Command	Purpose
Router(config-if)# source-bridge local-ring bridge-number target-ring	Configures an interface for SRB.



Note

Ring numbers need to be unique across interfaces and networks, so that when you enable source-route bridging over an interface the local and target rings are defined. Each node on the network will know if it is the target of explorer packets sent on the network.

A dual-port bridge is a limitation imposed by IBM Token Ring chips; the chips can process only two ring numbers. If you have a router with two or more Token Ring interfaces, you can work around the two-ring number limitation. You can configure your router as multiple dual-port bridges or as a multiport bridge using a virtual ring.

You can define several separate dual-port bridges in the same router. However, the routers on the LANs cannot have any-to-any connectivity; that is, they cannot connect to every other router on the bridged LANs. Only the routers connected to the dual-port bridge can communicate with one another. [Figure 24](#) shows two separate dual-port bridges (T0-T2 and T1-T3) configured on the same router.

Figure 24 Multiple Dual-Port Bridges

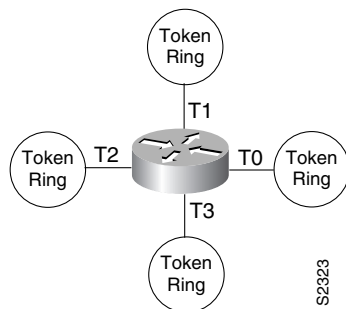

To configure multiple dual-port source-route bridges, use the following command in interface configuration mode for each Token Ring interface that is part of a dual-port bridge:

Command	Purpose
Router(config-if)# source-bridge <i>local-ring</i> <i>bridge-number target-ring</i>	Configures an interface for SRB.

If you want your network to use only SRB, you can connect as many routers as you need via Token Rings. Remember, source-route bridging requires you to bridge only Token Ring media.

Configuring a Multiport Bridge Using a Virtual Ring

A better solution for overcoming the two-ring number limitation of IBM Token Ring chips is to configure a multiport bridge using a virtual ring. A virtual ring on a multiport bridge allows the router to interconnect three or more LANs with any-to-any connectivity; that is, connectivity between any of the routers on each of the three LANs is allowed. A virtual ring creates a logical Token Ring internal to the Cisco IOS software, which causes all the Token Rings connected to the router to be treated as if they are all on the same Token Ring. The virtual ring is called a *ring group*. Figure 25 shows a multiport bridge using a virtual ring.

Figure 25 Multiport Bridge Using a Virtual Ring

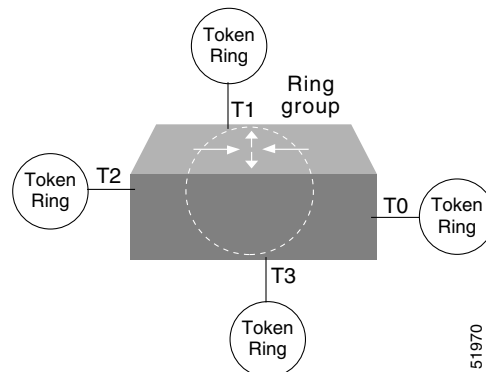

To take advantage of this virtual ring feature, each Token Ring interface on the router must be configured to belong to the same ring group. For information about configuring a multiport bridge using a virtual ring, see the “[Configuring a Multiport Bridge Using a Virtual Ring](#)” section on page 87.

To configure a source-route bridge to have more than two network interfaces, you must perform the following tasks:

1. Define a ring group.
2. Enable source-route-bridging and assign a ring group to a Token Ring interface.

Once you have completed these tasks, the router acts as a multiport bridge, not as a dual-port bridge.



Note

Ring numbers need to be unique across interfaces and networks.

Defining a Ring Group in SRB Context

Because all IBM Token Ring chips can process only two ring numbers, we have implemented the concept of a ring group or virtual ring. A ring group is a collection of Token Ring interfaces in one or more routers that share the same ring number. This ring number is used just like a physical ring number, showing up in any route descriptors contained in packets being bridged. Within the context of a multiport bridge that uses SRB rather than RSRB, the ring group resides in the same router. See the “Configuring Remote Source-Route Bridging” chapter to compare ring groups in the SRB and RSRB context.

A ring group must be assigned a ring number that is unique throughout the network. It is possible to assign different Token Ring interfaces on the same router to different ring groups, if, for example, you plan to administer them as interfaces in separate domains.

To define or remove a ring group, use one of the following commands in global configuration mode, as needed:

Command	Purpose
Router(config)# source-bridge ring-group <i>ring-group</i> [<i>virtual-mac-address</i>]	Defines a ring group.
Router(config)# no source-bridge ring-group <i>ring-group</i> [<i>virtual-mac-address</i>]	Removes a ring group.

Enabling SRB and Assigning a Ring Group to an Interface

After you have defined a ring group, you must assign that ring group to those interfaces you plan to include in that ring group. An interface can only be assigned to one ring group. To enable any-to-any connectivity among the end stations connected through this multiport bridge, you must assign the same target ring number to all Token Ring interfaces on the router.

To enable SRB and assign a ring group to an interface, use the following command in interface configuration mode:

Command	Purpose
Router(config-if)# source-bridge <i>local-ring</i> <i>bridge-number target-ring</i>	Configures an interface for SRB.

Configuring SRB over FDDI

Cisco’s implementation of SRB expands the basic functionality to allow autonomous switching of SRB network traffic for FDDI interfaces, adding counters to SRB accounting statistics, and implementing process-level switching of SRB over FDDI. This functionality provides a significant increase in performance for Token Rings interconnected across an FDDI backbone (Figure 26).

SRB over FDDI is supported on the Cisco 4000-M, Cisco 4500-M, Cisco 4700-M, Cisco 7000 series, Cisco 7200 series, and Cisco 7500 routers.

Figure 26 Autonomous FDDI SRB

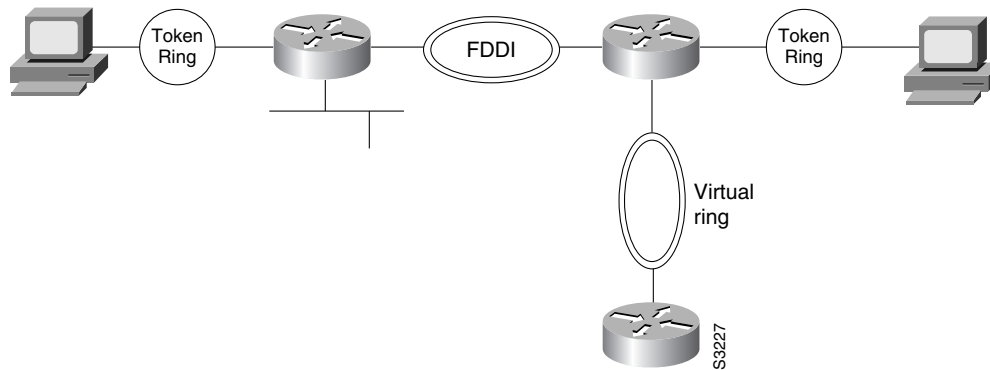

To configure autonomous FDDI SRB, use the following commands beginning in global configuration mode:

	Command	Purpose
Step 1	Router(config)# interface fddi <i>slot/port</i>	Configures an FDDI interface.
Step 2	Router(config-if)# source-bridge <i>local-ring bridge-number target-ring</i>	Configures an interface for SRB.
Step 3	Router(config-if)# source-bridge route-cache cbus	Enables autonomous switching.

Configuring Fast-Switching SRB over FDDI

Fast-Switching SRB over FDDI enhances performance. For example, if you want to use access-lists, fast-switching SRB over FDDI provides fast performance and access-list filters capability.

To configure fast-switching SRB over FDDI, use the following commands beginning in global configuration mode:

	Command	Purpose
Step 1	Router(config)# interface fddi <i>slot/port</i>	Configures an FDDI interface.
Step 2	Router(config-if)# source-bridge <i>local-ring bridge-number target-ring</i>	Configures an interface for SRB.
Step 3	Router(config-if)# source-bridge spanning	Enables source-bridge spanning.
Step 4	Router(config-if)# source-bridge route-cache	Enables fast-switching.
Step 5	Router(config-if)# multiring <i>protocol-keyword</i>	Enables the collection and use of RIF information.

Configuring SRB over Frame Relay

Cisco IOS software offers the ability to encapsulate SRB traffic using RFC 1490 Bridged 802.5 encapsulation. This provides SRB over Frame Relay functionality that is interoperable with other vendors' implementations of SRB over Frame Relay and with some vendors' implementations of FRAS BAN.



Note

In this release, SRB over Frame Relay does not support the Cisco IOS software proxy explorer, automatic spanning-tree, or LAN Network Manager functions.

To configure SRB over Frame Relay, use the following commands beginning in global configuration mode:

	Command	Purpose
Step 1	Router(config)# interface <i>serial number</i>	Specifies the serial port.
Step 2	Router(config-if)# encapsulation frame-relay	Enables Frame Relay encapsulation.
Step 3	Router(config-if)# interface serial slot/port.subinterface-number point-to-point	Configures a Frame Relay point-to-point subinterface.
Step 4	Router(config-if)# frame-relay interface-dlci dlci ietf	Configures a DLCI number for the point-to-point subinterface.
Step 5	Router(config-if)# source-bridge source-ring-number bridge-number target-ring-number conserve-ring	Assigns a ring number to the Frame Relay permanent virtual circuit.

Enabling the Forwarding and Blocking of Spanning-Tree Explorers

When trying to determine the location of remote destinations on a source-route bridge, the source device will need to send explorer packets. Explorer packets are used to collect routing information field (RIF) information. The source device can send spanning-tree explorers or all-routes explorers. Note that some older IBM devices generate only all-routes explorer packets, but many newer IBM devices are capable of generating spanning-tree explorer packets.

A spanning-tree explorer packet is an explorer packet that is sent to a defined group of nodes that comprise a statically configured spanning tree in the network. In contrast, an all-routes explorer packet is an explorer packet that is sent to every node in the network on every path.

Forwarding all-routes explorer packets is the default. However, in complicated source-route bridging topologies, using this default can generate an exponentially large number of explorers that are traversing the network. The number of explorer packets becomes quite large because duplicate explorer packets are sent across the network to every node on every path. Eventually each explorer packet will reach the destination device. The destination device will respond to each of these explorer packets. It is from these responses that the source device will collect the RIF and determine which route it will use to communicate with the destination device. Usually, the route contained in the first returned response will be used.

The number of explorer packets traversing the network can be reduced by sending spanning-tree explorer packets. Spanning-tree explorer packets are sent to specific nodes; that is, to only the nodes on the spanning tree, not to all nodes in the network. You must manually configure the spanning-tree topology over which the spanning-tree explorers are sent. You do this by configuring which interfaces on the routers will forward spanning-tree explorers and which interfaces will block them.

To enable forwarding of spanning-tree explorers on an outgoing interface, use the following command in interface configuration mode:

Command	Purpose
Router(config-if)# source-bridge spanning	Enables the forwarding of spanning-tree explorer packets on an interface.

**Note**

While enabling the forwarding of spanning-tree explorer packets is not an absolute requirement, it is strongly recommended in complex topologies. Configuring an interface to block or forward spanning-tree explorers has no effect on how that interface handles all-routes explorer packets. All-routes explorers can always traverse the network.

To block forwarding of spanning tree explorers on an outgoing interface, use the following command in interface configuration mode:

Command	Purpose
Router(config-if)# no source-bridge spanning	Blocks spanning-tree explorer packets on an interface.

Enabling the Automatic Spanning-Tree Function

The automatic spanning-tree function supports automatic resolution of spanning trees in SRB networks, which provides a single path for spanning explorer frames to traverse from a given node in the network to another. Spanning explorer frames have a single-route broadcast indicator set in the routing information field. Port identifiers consist of ring numbers and bridge numbers associated with the ports. The spanning-tree algorithm for SRB does not support Topology Change Notification bridge protocol data unit (BDPU).

**Note**

Although the automatic spanning-tree function can be configured with source-route translational bridging (SR/TLB), the SRB domain and transparent bridging domain have separate spanning trees. Each Token Ring interface can belong to only one spanning tree. Only one bridge group can run the automatic spanning-tree function at a time.

To create a bridge group that runs an automatic spanning-tree function compatible with the IBM SRB spanning-tree implementation, use the following command in global configuration mode:

Command	Purpose
Router(config)# bridge bridge-group protocol ibm	Creates a bridge group that runs the automatic spanning-tree function.

To enable the automatic spanning-tree function for a specified group of bridged interfaces, use the following command in interface configuration mode:

Command	Purpose
Router(config-if)# source-bridge spanning bridge-group	Enables the automatic spanning-tree function on a group of bridged interfaces.

To assign a path cost for a specified interface, use the following command in interface configuration mode:

Command	Purpose
Router(config-if) # source-bridge spanning <i>bridge-group path-cost path-cost</i>	Assigns a path cost for a specified group of bridged interfaces.

**Note**

Ports running IEEE and IBM protocols form a spanning tree together on the LAN, but they do not mix in the router itself. Make sure the configurations are correct and that each LAN runs only one protocol.

See the end of this chapter for an example of source-route bridging with the automatic spanning-tree function enabled.

Limiting the Maximum SRB Hops

You can minimize explorer storms if you limit the maximum number of source-route bridge hops. For example, if the largest number of hops in the best route between two end stations is six, it might be appropriate to limit the maximum source-route bridging hops to six to eliminate unnecessary traffic. This setting affects spanning-tree explorers and all-routes explorers sent from source devices.

To limit the number of SRB hops, use one of the following commands in interface configuration mode, as needed:

Command	Purpose
Router(config-if) # source-bridge max-hops <i>count</i>	Controls the forwarding or blocking of all-routes explorer frames received on this interface.
Router(config-if) # source-bridge max-in-hops <i>count</i>	Controls the forwarding or blocking of spanning-tree explorer frames received on this interface.
Router(config-if) # source-bridge max-out-hops <i>count</i>	Controls the forwarding or blocking of spanning-tree explorer frames sent from this interface.

Configuring Bridging of Routed Protocols

Source-route bridges use Media Access Control (MAC) information, specifically the information contained in the RIF, to bridge packets. A RIF contains a series of ring and bridge numbers that represent the possible paths the source node might use to send packets to the destination. Each ring number in the RIF represents a single Token Ring in the source-route bridged network and is designated by a unique 12-bit ring number. Each bridge number represents a bridge that is between two Token Rings in the SRB network and is designated by a unique 4-bit bridge number. The information in a RIF is derived from explorer packets traversing the source-route bridged network. Without the RIF information, a packet could not be bridged across a source-route bridged network.

Unlike source-route bridges, Level 3 routers use protocol-specific information (for example, Novell Internetwork Packet Exchange (IPX) or Xerox Network Systems (XNS) headers) rather than MAC information to route datagrams. As a result, the Cisco IOS software default for routed protocols is to not collect RIF information and to not be able to bridge routed protocols. However, if you want the software to bridge routed protocols across a source-route bridged network, the software must be able to collect

and use RIF information to bridge packets across a source-route bridged network. You can configure the software to append RIF information to routed protocols so that routed protocols can be bridged. [Figure 27](#) shows a network topology in which you would want to use this feature.

Figure 27 Topology for Bridging Routed Protocols across a Source-Route Bridged Network

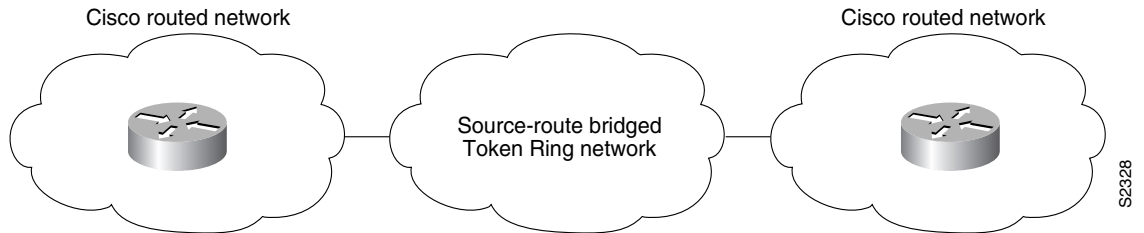

To configure the Cisco IOS software to bridge routed protocols, perform the following tasks:

- [Enabling Use of the RIF, page 93](#) (Required)
- [Configuring a Static RIF Entry, page 94](#) (Optional)
- [Configuring the RIF Timeout Interval, page 94](#) (Optional)

Enabling Use of the RIF

You can configure the Cisco IOS software so that it will append RIF information to the routed protocols. This allows routed protocols to be bridged across a source-route bridged network. The routed protocols that you can bridge are as follows:

- Apollo Domain
- AppleTalk
- ISO Connectionless Network Service (CLNS)
- DECnet
- IP
- IPX
- VINES
- XNS

Enable use of the RIF only on Token Ring interfaces on the router.

To configure the Cisco IOS software to append RIF information, use the following command in interface configuration mode:

Command	Purpose
<pre>Router(config-if)# multiring {protocol-keyword [all-routes spanning] all other}</pre>	Enables collection and use of RIF information.

For an example of how to configure the software to bridge routed protocols, see the [“SRB and Routing Certain Protocols Example”](#) section on page 124.

Configuring a Static RIF Entry

If a Token Ring host does not support the use of IEEE 802.2 TEST or XID datagrams as explorer packets, you might need to add static information to the RIF cache of the router.

To configure a static RIF entry, use the following command in global configuration mode:

Command	Purpose
Router(config)# rif <i>mac-address rif-string</i> { <i>interface-name</i> ring-group <i>ring</i> }	Enters static source-route information into the RIF cache.

Configuring the RIF Timeout Interval

RIF information that can be used to bridge routed protocols is maintained in a cache whose entries are aged.



Note

The **rif validate enable** commands have no effect on remote entries learned over RSRB.

To configure the number of minutes an inactive RIF entry is kept in the cache, use the following commands in global configuration mode:

	Command	Purpose
Step 1	Router(config)# rif timeout <i>minutes</i>	Specifies the number of minutes an inactive RIF entry is kept.
Step 2	Router(config)# rif validate-enable	Enables RIF validation for entries learned on an interface (Token Ring or FDDI).
Step 3	Router(config)# rif validate-enable-age	Enables RIF validation on an SRB that is malfunctioning.
Step 4	Router(config)# rif validate-enable-route-cache	Enables synchronization of the RIF cache with the protocol route cache.

Configuring Translation Between SRB and Transparent Bridging Environments

Source-route translational bridging (SR/TLB) is a Cisco IOS software feature that allows you to combine SRB and transparent bridging networks without the need to convert all of your existing source-route bridges to source-route transparent (SRT) nodes. As such, it provides a cost-effective connectivity path between Ethernets and Token Rings, for example.

When a router is configured for SR/TLB, the router operates in fast-switching mode by default, causing packets to be processed in the interrupt handler when the packets first arrive, rather than queuing them for scheduled processing. You can also use the **no source-bridge transparent fastswitch** command to disable fast-switched SR/TLB, causing the router to handle packets by process switching. For more information on disabling fast-switched SR/TLB, refer to the [“Disabling Fast-Switched SR/TLB” section on page 97](#).



Note

When you are translationally bridging, you will have to route routed protocols and translationally bridge all others, such as local-area transport (LAT).

Overview of SR/TLB

You can bridge packets between an SRB domain and a transparent bridging domain. Using this feature, a software “bridge” is created between a specified virtual ring group and a transparent bridge group. To the source-route station, this bridge looks like a standard source-route bridge. There is a ring number and a bridge number associated with a ring that actually represents the entire transparent bridging domain. To the transparent bridging station, the bridge represents just another port in the bridge group.

When bridging from the SRB (typically, Token Ring) domain to the transparent bridging (typically, Ethernet) domain, the source-route fields of the frames are removed. The RIFs are cached for use by subsequent return traffic.

When bridging from the transparent bridging domain to the SRB domain, the router checks the packet to see if it has a multicast or broadcast destination or a unicast (single host) destination. If it is multicast, the packet is sent as a spanning-tree explorer. If it is a unicast destination, the router looks up the path to the destination in the RIF cache. If a path is found, it will be used; otherwise, the router will send the packet as a spanning-tree explorer.

An example of a simple SR/TLB topology is shown in [Figure 28](#).

Figure 28 Example of a Simple SR/TLB Topology

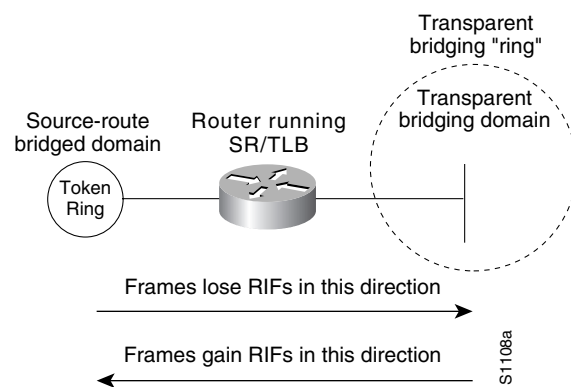

Note

The Spanning Tree Protocol messages used to prevent loops in the transparent bridging domain are *not* passed between the SRB domain and the transparent bridging domain. Therefore, you must not set up multiple paths between the SRB and transparent bridging domains.

The following notes and caveats apply to all uses of SR/TLB:

- Multiple paths cannot exist between the source-route bridged domain and the transparent bridged domain. Such paths can lead to data loops in the network, because the spanning-tree packets used to avoid these loops in transparent bridging networks do not traverse the SRB network.
- Some devices, notably PS/2s under certain configurations running OS/2 Extended Edition Version 1.3, do not correctly implement the “largest frame” processing on RIFs received from remote source-route bridged hosts. The maximum Ethernet frame size is smaller than that allowed for Token Ring. As such, bridges allowing for communication between Ethernet and Token Ring will tell the Token Ring hosts, through the RIF on frames destined to the Token Ring, that hosts on the Ethernet cannot receive frames larger than a specified maximum, typically 1472 bytes. Some machines ignore this run-time limit specification and send frames larger than the Ethernet can accept. The router and any other Token Ring/Ethernet bridge has no choice but to drop these frames. To allow such hosts to successfully communicate across or to an Ethernet, you must configure their maximum frame sizes manually. For the PS/2, this can be done through Communications Manager.

- Any access filters applied on any frames apply to the frames as they appear on the media to which the interface with the access filter applies. This is important because in the most common use of SR/TLB (Ethernet and Token Ring connectivity), the bit ordering of the MAC addresses in the frame is swapped. Refer to the SR/TLB examples in the “SRB Configuration Examples” section of this chapter.

**Caution**

Bridging between dissimilar media presents several problems that can prevent communication from occurring. These problems include bit order translation (or usage of MAC addresses as data), maximum transmission unit (MTU) differences, frame status differences, and multicast address usage. Some or all of these problems might be present in a multimedia bridged LAN and prevent communication from taking place. Because of differences in the way end nodes implement Token Ring, these problems are most prevalent when bridging between Token Rings and Ethernets or between Token Ring and FDDI LANs.

Problems can occur with the following protocols when bridged between Token Ring and other media: Novell IPX, DECnet Phase IV, AppleTalk, VINES, XNS, and IP. Further, problems can occur with the Novell IPX and XNS protocols when bridged between FDDI and other media. Cisco recommends that these protocols be routed whenever possible.

To enable SR/TLB, you must perform the task in the following section:

- [Enabling Bridging between Transparent Bridging and SRB, page 96](#)

In addition, you can also perform the tasks in the following sections:

- [Disabling Fast-Switched SR/TLB, page 97](#)
- [Enabling Translation Compatibility with IBM 8209 Bridges, page 97](#)
- [Enabling Token Ring LLC2-to-Ethernet Conversion, page 97](#)

Enabling Bridging between Transparent Bridging and SRB

Before enabling bridging, you must have completely configured your router using multiport SRB and transparent bridging. Once you have done this, to establish bridging between transparent bridging and source-route bridging, use the following command in global configuration mode:

Command	Purpose
Router(config)# source-bridge transparent <i>ring-group pseudo-ring bridge-number tb-group</i> [oui]	Enables bridging between transparent bridging and SRB.

Disabling Fast-Switched SR/TLB

To disable fast-switched SR/TLB and cause the router to handle packets by process switching, use the following command in global configuration mode:

Command	Purpose
<code>Router(config)# no source-bridge transparent ring-group fastswitch</code>	Disables fast-switched SR/TLB.

Enabling Translation Compatibility with IBM 8209 Bridges

To transfer data between IBM 8209 Ethernet/Token Ring bridges and routers running the SR/TLB software (to create a Token Ring backbone to connect Ethernets), use the following command on each Token Ring interface in interface configuration mode:

Command	Purpose
<code>Router(config-if)# ethernet-transit-oui [90-compatible standard cisco]</code>	Moves data between IBM 8209 Ethernet/Token Ring bridges and routers running translational bridging software.

Enabling Token Ring LLC2-to-Ethernet Conversion

The Cisco IOS software supports the following types of Token Ring-to-Ethernet frame conversions using Logical Link Control, type 2 (LLC2) Protocol:

- Token Ring LLC2 to Ethernet Type II (0x80d5 processing)
- Token Ring LLC2 to Ethernet 802.3 LLC2 (standard)

For most non-IBM hosts, Token Ring LLC2 frames can be translated in a straightforward manner into Ethernet 802.3 LLC2 frames. This is the default conversion in the Cisco IOS software.

However, many Ethernet-attached IBM devices use nonstandard encapsulation of LLC2 on Ethernet. Such IBM devices, including PS/2s running OS/2 Extended Edition and RT-PCs, do not place their LLC2 data inside an 802.3 format frame, but rather place it into an Ethernet Type 2 frame whose type is specified as *0x80d5*. This nonstandard format is called *0x80d5*, named after the type of frame. This format is also sometimes called *RT-PC Ethernet format* because these frames were first widely seen on the RT-PC. Hosts using this nonstandard *0x80d5* format cannot read the standard Token Ring LLC2 to Ethernet 802.2 LLC frames.

To enable Token Ring LLC2 to Ethernet LLC2 conversion, you can perform one or both of the following tasks:

- [Enable 0x80d5 Processing, page 97](#)
- [Enable Standard Token Ring LLC2-to-Ethernet LLC2 Conversion, page 98](#)

Enable 0x80d5 Processing

You can change the Cisco IOS software's default translation behavior of translating Token Ring LLC to Ethernet 802.3 LLC to translate Token Ring LLC2 frames into Ethernet 0x80d5 format frames. To enable this nonstandard conversion, use the following command in global configuration mode:

Command	Purpose
<code>Router(config)# source-bridge enable-80d5</code>	Changes the Ethernet/Token Ring translation behavior to translate Token Ring LLC2 frames into Ethernet 0x80d5 format frames.

Enable Standard Token Ring LLC2-to-Ethernet LLC2 Conversion

After you change the translation behavior to perform Token Ring LLC2 frames into Ethernet 0x80d5 format frames, some of the non-IBM hosts in your network topology might use the standard Token Ring conversion of Token Ring LLC2 to 802.3 LLC2 frames. If this is the case, you can change the translation method of those hosts to use the standard translation method on a per-DSAP basis. The translation method for all the IBM hosts would still remain as Token Ring LLC2 to Ethernet 0x80d5 translation.

To define non-IBM hosts in your network topology to use the standard translation method while the IBM hosts use the nonstandard method, use the following command in global configuration mode:

Command	Purpose
Router (config)# source-bridge sap-80d5 dsap	Allows some other devices to use normal LLC2/IEEE 802.3 translation on a per-DSAP basis.

Configuring NetBIOS Support

NetBIOS is a nonroutable protocol that was originally designed to send messages between stations, typically IBM PCs, on a Token Ring network. NetBIOS allows messages to be exchanged between the stations using a name rather than a station address. Each station knows its name and is responsible for knowing the names of other stations on the network.



Note

In addition to this type of NetBIOS, which runs over LLC2, we have implemented another type of NetBIOS that runs over IPX. For information on the IPX type of NetBIOS, refer to the chapter “Configuring Novell IPX” in the *Cisco IOS AppleTalk and Novell IPX Configuration Guide*.

NetBIOS name caching allows the Cisco IOS software to maintain a cache of NetBIOS names, which avoids the high overhead of sending many of the broadcasts used between client and server NetBIOS PCs (IBM PCs or PS/2s) in an SRB environment.

When NetBIOS name caching is enabled, the software performs the following actions:

- Notices when any hosts send a series of duplicated “query” frames and reduces them to one frame per period. The time period is configurable.
- Keeps a cache of mappings between NetBIOS server and client names and their MAC addresses. By watching NAME_QUERY and NAME_RECOGNIZED request and response traffic between clients and servers, the Cisco IOS software can forward broadcast requests sent by clients to find servers (and by servers in reply to their clients) directly to their needed destinations, rather than forwarding them for broadcast across the entire bridged network.

The software will time out the entries in the NetBIOS name cache after a specific interval of their initial storage. The timeout value is a user-configurable value. You can configure the timeout value for a particular Token Ring if the NetBIOS name cache is enabled on the interface connecting to that Token Ring. In addition, you can configure static name cache entries that never time out for frequently accessed servers whose locations or paths typically do not change. Static RIF entries are also specified for such hosts.

Generally, NetBIOS name caching is most useful when a large amount of NetBIOS broadcast traffic creates bottlenecks on WAN media connecting distant locations, and the WAN media is overwhelmed with this traffic. However, when two high-speed LAN segments are directly interconnected, the packet savings of NetBIOS name caching is probably not worth the processor overhead associated with it.

**Note**

NetBIOS name caching is not recommended to be turned on in backbone routers, particularly if you have it enabled in all the routers connected to the backbone. NetBIOS caching should be distributed among multiple routers. NetBIOS name caching can be used only between Cisco routers that are running software Release 9.1 or later.

To enable NetBIOS name caching, you must perform the tasks in the following sections:

- [Enabling the Proxy Explorers Feature on the Appropriate Interface, page 99](#)
- [Specifying Timeout and Enabling NetBIOS Name Caching, page 100](#)

In addition, you can configure NetBIOS name caching as described in the following sections:

- [Configuring the NetBIOS Cache Name Length, page 100](#)
- [Enabling NetBIOS Proxying, page 100](#)
- [Creating Static Entries in the NetBIOS Name Cache, page 101](#)
- [Specifying Dead-Time Intervals for NetBIOS Packets, page 101](#)

Enabling the Proxy Explorers Feature on the Appropriate Interface

To enable NetBIOS name caching on an interface, the proxy explorers feature must first be enabled on that interface. This feature must either be enabled for response to all explorer packets or for response to NetBIOS packets only.

To determine whether the proxy explorers feature has been enabled, use the following command in privileged EXEC mode:

Command	Purpose
Router# more nvram:startup-config	Displays the startup configuration file contained in NVRAM or specified by the CONFIG_FILE environment variable.

To determine whether proxy explorers has been configured for response to all explorer packets, look in the configuration file for the **source-bridge proxy-explorer** entry for the appropriate interface. For example, if the appropriate interface is Token Ring 0, look for an entry similar to the following:

```
interface tokenring 0
source-bridge proxy-explorer
```

If that entry does not exist, look for the **source-bridge proxy-netbios-only** entry for the appropriate interface.

If neither entry exists, proxy explorers has not yet been enabled for the appropriate interface. To enable proxy explorers for response to all explorer packets, refer to the section “Configure Proxy Explorers” later in this chapter.

Otherwise, enable proxy explorers only for the NetBIOS name caching function by using the following command in global configuration mode:

Command	Purpose
Router(config)# source-bridge proxy-netbios-only	Enables use of proxy explorers only for the NetBIOS name caching function and not for their general local response to explorers.

Specifying Timeout and Enabling NetBIOS Name Caching

After you have ensured that the proxy explorers feature has been enabled for the appropriate interface, you can specify a cache timeout and enable NetBIOS name caching. To do this, use the following commands in global configuration mode:

	Command	Purpose
Step 1	Router(config)# netbios name-cache timeout <i>minutes</i>	Enables NetBIOS name caching and sets the time that entries can remain in the NetBIOS name cache.
Step 2	Router(config)# netbios enable-name-cache	Enables NetBIOS name caching.

Configuring the NetBIOS Cache Name Length

To specify how many characters of the NetBIOS type name that the name cache will validate, use the following command in global configuration mode:

Command	Purpose
Router(config)# netbios name-cache name-len <i>length</i>	Specifies how many characters of the NetBIOS type name the name cache will validate.

Enabling NetBIOS Proxying

The Cisco IOS software can act as a proxy and send NetBIOS datagram type frames. To enable this capability, use the following command in global configuration mode:

Command	Purpose
Router(config)# netbios name-cache proxy-datagram <i>seconds</i>	Enables the Cisco IOS software to act as a proxy and send NetBIOS datagram type frames.

To define the validation time when the software is acting as a proxy for NetBIOS NAME_QUERY command or for explorer frames, use the following global configuration command:

Command	Purpose
Router(config)# rif validate-age <i>seconds</i>	Defines validation time.

Creating Static Entries in the NetBIOS Name Cache

If the router communicates with one or more NetBIOS stations on a regular basis, adding static entries to the NetBIOS name cache for these stations can reduce network traffic and overhead. You can define a static NetBIOS name cache entry that associates the server with the NetBIOS name and the MAC address. If the router acts as a NetBIOS server, you can specify that the static NetBIOS name cache is available locally through a particular interface. If a remote router acts as the NetBIOS server, you can specify that the NetBIOS name cache is available remotely. To do this, use one of the following commands in global configuration mode, as needed:

Command	Purpose
Router(config)# netbios name-cache <i>mac-address netbios-name interface-name</i>	Defines a static NetBIOS name cache entry, tying the server with the name netbios-name to the mac-address, and specifying that the server is accessible locally through the interface-name specified.
Router(config)# netbios name-cache <i>mac-address netbios-name ring-group</i> <i>group-number</i>	Defines a static NetBIOS name cache entry, tying the server with the name netbios-name to the mac-address, and specifying that the server is accessible remotely through the ring-group group-number specified.

If you have defined a NetBIOS name cache entry, you must also define a RIF entry. For an example of how to configure a static NetBIOS entry, see the [“NetBIOS Support with a Static NetBIOS Cache Entry Example”](#) section on page 133.

Specifying Dead-Time Intervals for NetBIOS Packets

When NetBIOS name caching is enabled and default parameters are set on the router (and the NetBIOS name server and the NetBIOS name client), approximately 20 broadcast packets per login are kept on the local ring where they are generated. The broadcast packets are of the type ADD_NAME_QUERY, ADD_GROUP_NAME, and STATUS_QUERY.

The Cisco IOS software also converts pairs of FIND_NAME and NAME_RECOGNIZED packets received from explorers, which traverse all rings, to specific route frames that are sent only between the two machines that need to see these packets.

You can specify a query-timeout, or “dead-time” interval to prevent repeat or duplicate broadcast of these type of packets for the duration of the interval.

To specify dead time intervals, use the following commands in global configuration mode, as needed:

Command	Purpose
Router(config)# netbios name-cache query-timeout <i>seconds</i>	Specifies a dead time interval during which the Cisco IOS software drops any broadcast (NetBIOS ADD_NAME_QUERY, ADD_GROUP_NAME, or STATUS_QUERY) frames if they are duplicate frames sent by the same host.
Router(config)# netbios name-cache recognized-timeout <i>seconds</i>	Specifies a dead time interval during which the software drops FIND_NAME and NAME_RECOGNIZED frames if they are duplicate frames sent by the same host.

Configuring LNM Support

LAN Network Manager (LNM), formerly called LAN Manager, is an IBM product for managing a collection of source-route bridges. Using either a proprietary protocol or the Simple Network Management Protocol (SNMP), LNM allows you to monitor the entire collection of Token Rings that comprise your source-route bridged network. You can use LNM to manage the configuration of source-route bridges, monitor Token Ring errors, and gather information from Token Ring parameter servers.



Note

LNM is supported on the 4/16-Mb Token Ring cards that can be configured for either 4- or 16-Mb transmission speeds. LNM support is not provided on CSC-R16M cards with SBEMON 2.0.

LNM is not limited to managing locally attached Token Ring networks; it also can manage any other Token Rings in your source-route bridged network that are connected through non-Token Ring media. To accomplish this task, LNM works in conjunction with the IBM Bridge Program. The IBM Bridge Program gathers data about the local Token Ring network and relays it back to LNM. In this manner, the bridge program becomes a proxy for information about its local Token Ring. Without this ability, you would require direct access to a device on every Token Ring in the network. This process would make managing an SRB environment awkward and cumbersome.

Figure 29 shows some Token Rings attached through a cloud and one LNM linking to a source-route bridge on each local ring.

Figure 29 LNM Linking to a Source-Route Bridge on Each Local Ring

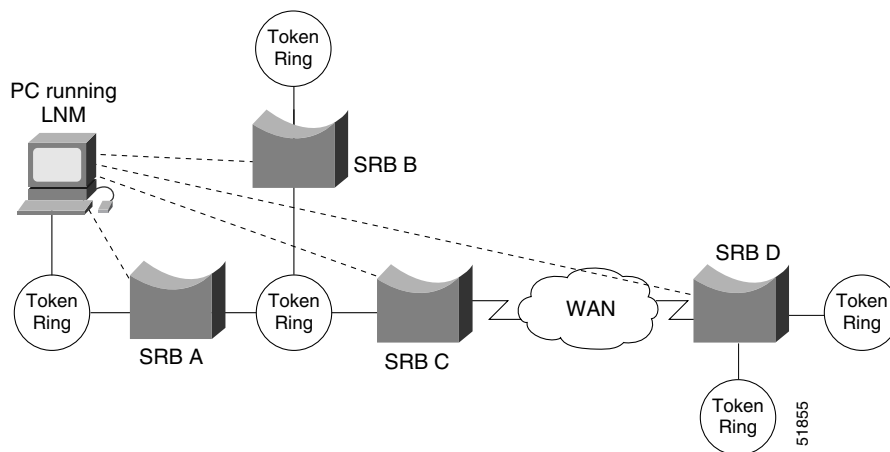

If LNM requires information about a station somewhere on a Token Ring, it uses a proprietary IBM protocol to query to one of the source-route bridges connected to that ring. If the bridge can provide the requested information, it simply responds directly to LNM. If the bridge does not have the necessary information, it queries the station using a protocol published in the IEEE 802.5 specification. In either case, the bridge uses the proprietary protocol to send a valid response back to LNM, using the proprietary protocol.

As an analogy, consider a language translator who sits between a French-speaking diplomat and a German-speaking diplomat. If the French diplomat asks the translator a question in French for the German diplomat and the translator knows the answer, he or she simply responds without translating the original question into German. If the French diplomat asks a question the translator does not know how to answer, the translator must first translate the question to German, wait for the German diplomat to answer, and then translate the answer back to French.

Similarly, if LNM queries a source-route bridge in the proprietary protocol and the bridge knows the answer, it responds directly using the same protocol. If the bridge does not know the answer, it must first translate the question to the IEEE 802.5 protocol, query the station on the ring, and then translate the response back to the proprietary protocol to send to LNM.

Figure 30 illustrates requests from the LNM originating in an IBM proprietary protocol and then translated into IEEE 802.5 MAC-level frames.

Figure 30 LAN Network Manager Monitoring and Translating

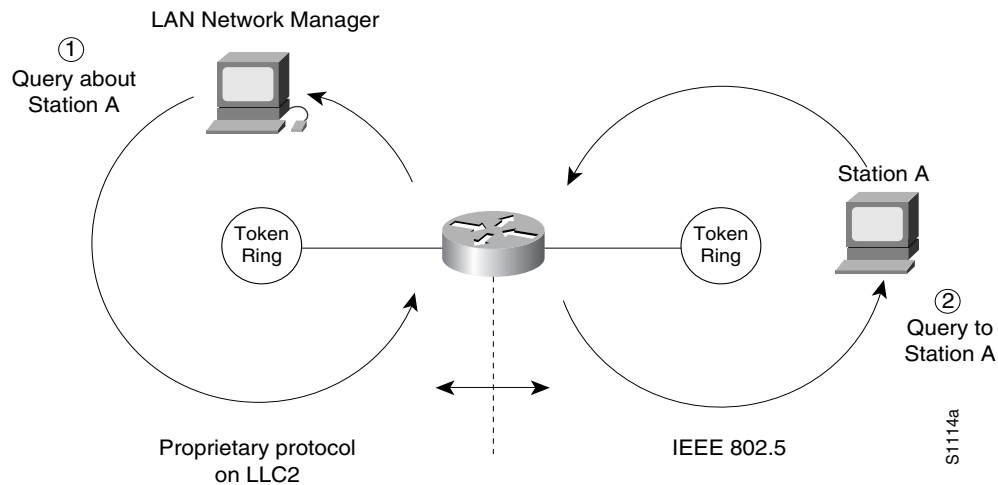

Notice that the proprietary protocol LNM uses to communicate with the source-route bridge is an LLC2 connection. Although its protocol cannot be routed, LNM can monitor or manage anything within the SRB network.

How a Router Works with LNM

Cisco routers using 4/16-Mbps Token Ring interfaces configured for SRB support the proprietary protocol that LNM uses. These routers provide all functions the IBM Bridge Program currently provides. Thus LNM can communicate with a router as if it were an IBM source-route bridge, such as the IBM 8209, and can manage or monitor any Token Ring connected to the router.

Through IBM Bridge support, LNM provides three basic services for the SRB network:

- The Configuration Report Server (CRS) monitors the current logical configuration of a Token Ring and reports any changes to LNM. CRS also reports various other events, such as the change of an active monitor on a Token Ring.
- The Ring Error Monitor (REM) monitors errors reported by any station on the ring. In addition, REM monitors whether the ring is in a functional or a failure state.
- The Ring Parameter Server (RPS) reports to LNM when any new station joins a Token Ring and ensures that all stations on a ring are using a consistent set of reporting parameters.

IBM Bridge support for LNM also allows asynchronous notification of some events that can occur on a Token Ring. Examples of these events include notification of a new station joining the Token Ring or of the ring entering failure mode, known as *beaconing*. Support is also provided for LNM to change the operating parameters in the bridge. For a complete description of LNM, refer to the IBM product manual supplied with the LNM program.

LNМ support in our source-route bridges is a powerful tool for managing SRB networks. Through the ability to communicate with LNМ and to provide the functionality of the IBM Bridge Program, our device appears as part of the IBM network. You therefore gain from the interconnectivity of our products without having to learn a new management product or interface.

When SRB is enabled on the router, configuring the Cisco IOS software to perform the functions of an IBM Bridge for communication with LNМ occurs automatically. Therefore, if SRB has been enabled, you do not need to perform any tasks to enable LNМ support. However, the LNМ software residing on a management station on a Token Ring on the network should be configured to properly communicate with the router.

There are several options for modifying LNМ parameters in the Cisco IOS software, but none are required for basic functionality. For example, because users can now modify the operation of the Cisco IOS software through SNMP and through LNМ, there is an option to exclude a user from modifying the Cisco IOS software configuration through LNМ. You also can specify which of the three LNМ services (CRS, REM, RPS) the source-route bridge will perform.

To configure LNМ support, perform the tasks in the following sections:

- [Configuring LNМ Software on the Management Stations to Communicate with the Router, page 104](#)
- [Disabling LNМ Functionality, page 104](#)
- [Disabling Automatic Report Path Trace Function, page 105](#)
- [Preventing LNМ Stations from Modifying Cisco IOS Software Parameters, page 105](#)
- [Enabling Other LRMs to Change Router Parameters, page 105](#)
- [Applying a Password to an LNМ Reporting Link, page 106](#)
- [Enabling LNМ Servers, page 106](#)
- [Changing Reporting Thresholds, page 106](#)
- [Changing an LNМ Reporting Interval, page 107](#)
- [Enabling the RPS Express Buffer Function, page 107](#)
- [Monitoring LNМ Operation, page 107](#)

Configuring LNМ Software on the Management Stations to Communicate with the Router

Because configuring an LNМ station is a fairly simple task and is well covered in the LNМ documentation, it is not covered in depth here. However, it is important to mention that you must enter the MAC addresses of the interfaces comprising the ports of the bridges as adapter addresses. When you configure the router as a multiport bridge, configuring an LNМ station is complicated by the virtual ring that is involved. The basic problem extends from the fact that LNМ is designed to only understand the concept of a two-port bridge, and the router with a virtual ring is a *multiport* bridge. The solution is to configure a virtual ring into the LNМ Manager station as a series of dual-port bridges.

Disabling LNМ Functionality

Under some circumstances, you can disable all LNМ server functions on the router without having to determine whether to disable a specific server, such as the ring parameter server or the ring error monitor on a given interface.

To disable LNМ functionality, use the following command in global configuration mode:

Command	Purpose
Router(config)# lnm disabled	Disables LNM functionality.

The command can be used to terminate all LNM server input and reporting links. In normal circumstances, this command should not be necessary because it is a superset of the functions normally performed on individual interfaces by the **no lnm rem** and **no lnm rps** commands.

Disabling Automatic Report Path Trace Function

Under some circumstances, such as when new hardware has been introduced into the network and is causing problems, the automatic report path trace function can be disabled. The new hardware may be setting bit-fields B1 or B2 (or both) of the routing control field in the routing information field embedded in a source-route bridged frame. This condition may cause the network to be flooded by report path trace frames if the condition is persistent. The **lnm pathtrace-disabled** command, along with its options, allows you to alleviate network congestion that may be occurring by disabling all or part of the automatic report path trace function within LNM.

To disable the automatic report path trace function, use the following command in global configuration mode:

Command	Purpose
Router(config)# lnm pathtrace-disabled [all origin]	Disables LNM automatic report path trace function.

Preventing LNM Stations from Modifying Cisco IOS Software Parameters

Because there is more than one way to remotely change parameters in a router (either using SNMP or the proprietary IBM protocol), some method is needed to prevent such changes from detrimentally interacting with each other. You can prevent any LNM station from modifying parameters in the Cisco IOS software. It does not affect the ability of LNM to monitor events, only to change parameters on the router.

To prevent the modification of Cisco IOS software parameters by an LNM station, use the following command in global configuration mode:

Command	Purpose
Router(config)# lnm snmp-only	Prevents LNM stations from modifying LNM parameters in the Cisco IOS software.

Enabling Other LRMs to Change Router Parameters

LNM has a concept of reporting links and reporting link numbers. A reporting link is simply a connection (or potential connection) between a LAN Reporting Manager (LRM) and a bridge. A reporting link number is a unique number used to identify a reporting link. An IBM bridge allows four simultaneous reporting links numbered 0 through 3. Only the LRM attached on the lowest-numbered connection is allowed to change LNM parameters in the router, and then only when that connection number falls below a certain configurable number. In the default configuration, the LRM connected through link 0 is the only LRM that can change LNM parameters.

To enable other LRMs to change router parameters, use the following command in interface configuration mode:

Command	Purpose
Router(config-if)# lnm alternate <i>number</i>	Enables a LRM other than that connected through link 0 to change router parameters.

Applying a Password to an LNM Reporting Link

Each reporting link has its own password that is used not only to prevent unauthorized access from an LRM to a bridge but to control access to the different reporting links. This is important because it is possible to change parameters through some reporting links.

To apply a password to an LNM reporting link, use the following command in interface configuration mode:

Command	Purpose
Router(config-if)# lnm password <i>number string</i>	Applies a password to an LNM reporting link.

Enabling LNM Servers

As in an IBM bridge, the router provides several functions that gather information from a local Token Ring. All of these functions are enabled by default, but also can be disabled. The LNM servers are explained in the [“How a Router Works with LNM”](#) section on page 103.

To enable LNM servers, use one of the following commands in interface configuration mode, as needed:

Command	Purpose
Router(config-if)# lnm crs	Enables the LNM Configuration Report Server (CRS).
Router(config-if)# lnm rem	Enables the LNM Ring Error Monitor (REM).
Router(config-if)# lnm rps	Enables the LNM Ring Parameter Server (RPS).

Changing Reporting Thresholds

The Cisco IOS software sends a message to all attached LNMs whenever it begins to drop frames. The threshold at which this report is generated is based on a percentage of frames dropped compared with those forwarded. This threshold is configurable, and defaults to a value of 0.10 percent. You can configure the threshold by entering a single number, expressing the percentage loss rate in hundredths of a percent. The valid range is 0 to 9999.

To change reporting thresholds, use the following command in interface configuration mode:

Command	Purpose
Router(config-if)# lnm loss-threshold <i>number</i>	Changes the threshold at which the Cisco IOS software reports the frames-lost percentage to LNM.

Changing an LNM Reporting Interval

All stations on a Token Ring notify the Ring Error Monitor (REM) when they detect errors on the ring. In order to prevent excessive messages, error reports are not sent immediately, but are accumulated for a short interval and then reported. A station learns the duration of this interval from a router (configured as a source-route bridge) when it first enters the ring. This value is expressed in tens of milliseconds between error messages. The default is 200, or 2 seconds. The valid range is 0 to 65535.

To change an LNM reporting interval, use the following command in interface configuration mode:

Command	Purpose
Router(config-if)# lnm softerr <i>milliseconds</i>	Sets the time interval in which the Cisco IOS software will accumulate error messages before sending them.

Enabling the RPS Express Buffer Function

The RPS express buffer function allows the router to set the express buffer bit to ensure priority service for frames required for ring station initiation. When this function is enabled, the router sets the express buffer bit in its initialize ring station response. This allows Token Ring devices to insert into the ring during bursty conditions.

To enable LNM to use the RPS express buffer function, use the following command in interface configuration mode:

Command	Purpose
Router(config-if)# lnm express-buffer	Enables the LNM RPS express buffer function.

Monitoring LNM Operation

Once LNM support is enabled, you can monitor LNM operation. To observe the configuration of the LNM bridge and its operating parameters, use the following commands in privileged EXEC mode:

	Command	Purpose
Step 1	Router# show lnm bridge	Displays all configured bridges and their global parameters.
Step 2	Router# show lnm config	Displays the logical configuration of all bridges configured in the router.
Step 3	Router# show lnm interface [<i>type number</i>]	Displays LNM information for an interface or all interfaces of the router.
Step 4	Router# show lnm ring [<i>ring-number</i>]	Displays LNM information about a Token Ring or all Token Rings on the network.
Step 5	Router# show lnm station [<i>address</i>]	Displays LNM information about a station or all known stations on all rings.

Configuring ATM Support

Cisco IOS software supports RFC 1483, enabling the transfer of network interconnect traffic over ATM AAL5 layer using LLC encapsulation. RFC 1483 defines an encapsulation type for transferring LAN data via ATM networks. All LAN protocols that use the LLC format and run on Ethernet, Token Ring, or ATM networks are encapsulated in LLC data packets transported via ATM networks. This enhancement provides an SRB over ATM functionality that is interoperable with other vendors' implementations of SRB over ATM.

RFC 1483 also provides the following benefits:

- Flexibility to implement traffic policies pertaining to traffic shaping and various congestion control mechanisms
- Load balancing of traffic guarantees that LAN data is sent
- Cost effectiveness of using PVCs instead of LANE in small networks
- Transfer of connectionless LAN data over a connection-oriented ATM network
- Support for IP and IPX routing, using RFC 1483 Routed PDUs

RFC 1483 enables SRB between Token Ring LANs connected over an ATM network, using RFC 1483 bridged PDUs in the following scenarios:

- Two-port and multipoint SRB between Token Ring LANs connected via RFC 1483 AAL5Snap permanent virtual circuits (PVCs), using bridged PDUs.
- Two-port and multipoint SRB between Token Ring LANs (using RFC 1483 AAL5Snap PVCs) and LANs, VLANs, or ELANs with SRB (using bridged PDUs).

RFC 1483 also supports two-port and multipoint Source Route/Translational Bridging (SR/TLB) between Token Ring, Ethernet and their respective emulated LANS, using RFC 1483 bridged PDUs.

SR/TLB can be configured to connect transparent bridging and SRB domains. Transparent bridging forwards incoming packets based on a destination MAC address that yields a RIF to be added to the packet. SRB forwards packets based on destination MAC address, which is listed in the transparent bridging table. Both SRB explorers and transparent bridging multicast packets are forwarded and extended.

The following guidelines apply to RFC 1483 configuration:

- Assign a unique number to the PVC that connects two nodes. When SRB is configured, the router determines the PVC on which the frame is to be forwarded and treats it as a Token Ring interface. In a large network, the availability of enough unique virtual ring numbers for PVCs might be a limitation.
- Conserve the virtual ring number on the PVC and configure the routers so that they use the same ring numbers that are assigned to the PVCs.

To configure SRB over ATM, use the following commands beginning in global configuration mode:

	Command	Purpose
Step 1	Router(config)# interface atm <i>slot/port</i>	Specifies the ATM interface.
Step 2	Router(config-if)# interface atm <i>slot/port</i> [subinterface- <i>number</i> { multipoint point-to-point }]	Specifies the ATM main interface or subinterface to which discovered PVCs will be assigned.

	Command	Purpose
Step 3	Router(config-if)# atm pvc vcd vpi vci aal-encap [[midlow midhigh] [peak average [burst]]] [inarp [minutes]] [oam [seconds]]	Creates a PVC on an ATM interface.
Step 4	Router(config-if)# source-bridge local-ring bridge-number target-ring-number conserve-ring	Assigns a ring number to the ATM PVC.
Step 5	Router(config-if)# source-bridge spanning bridge-group	Enables the automatic spanning-tree function on a group of bridged interfaces.

For more information, see one of the following sections:

- [Back-to-Back Routers ATM Configuration Example, page 141](#)
- [Single ATM PVC and Single Virtual Ring Per Router Configuration Example, page 142](#)
- [Multiple ATM PVCs and Multiple Virtual Rings on One Router Configuration Example, page 143](#)
- [Multiple ATM PVCs with a Single Virtual Ring on the Router Configuration Example, page 144](#)

Securing the SRB Network

This section describes how to configure three features that are used primarily to provide network security: NetBIOS access filters, administrative filters, and access expressions that can be combined with administrative filters. In addition, these features can be used to increase network performance because they reduce the number of packets that traverse the backbone network.

Configuring NetBIOS Access Filters

NetBIOS packets can be filtered when sent across a Token Ring bridge. Two types of filters can be configured:

- Host access list
Used for source and destination station names
- Byte offset access list
Used for arbitrary byte patterns in the packet itself.

As you configure NetBIOS access filters, keep the following issues in mind:

- The access lists that apply filters to an interface are scanned in the order they are entered.
- There is no way to put a new access list entry in the middle of an access list. All new additions to existing NetBIOS access lists are placed at the end of the existing list.
- Access list arguments are case sensitive. The software makes a literal translation, so that a lowercase “a” is different from an uppercase “A.” (Most nodes are named in uppercase letters.)
- A host NetBIOS access list and byte NetBIOS access list can each use the same name. The two lists are identified as unique and bear no relationship to each other.

- The station names included in the access lists are compared with the source name field for NetBIOS commands 00 and 01 (ADD_GROUP_NAME_QUERY and ADD_NAME_QUERY), and with the destination name field for NetBIOS commands 08, 0A, and 0E (DATAGRAM, NAME_QUERY, and NAME_RECOGNIZED).
- If an access list does not contain a particular station name, the default action is to deny the access to that station.

To minimize any performance degradation, NetBIOS access filters do not examine all packets. Rather, they examine certain packets that are used to establish and maintain NetBIOS client/server connections, thereby effectively stopping new access and load across the router. However, applying a new access filter does not terminate existing sessions immediately. All new sessions will be filtered, but existing sessions could continue for some time.

There are two ways you can configure NetBIOS access filters:

- [Configure NetBIOS Access Filters Using Station Names, page 110](#)
- [Configuring NetBIOS Access Filters Using a Byte Offset, page 110](#)

Configure NetBIOS Access Filters Using Station Names

To configure access filters using station names, you must do the following:

1. Assign the station access list name.
2. Specify the direction of the message to be filtered on the interface.

The NetBIOS station access list contains the station name to match, along with a permit or deny condition. You must assign the name of the access list to a station or set of stations on the network.

To assign a station access list name, use the following command in global configuration mode:

Command	Purpose
Router(config)# netbios access-list host name { permit deny } <i>pattern</i>	Assigns the name of an access list to a station or set of stations on the network.

When filtering by station name, you can choose to filter either incoming or outgoing messages on the interface. To specify the direction, use one of the following commands in interface configuration mode, as needed:

Command	Purpose
Router(config-if)# netbios input-access-filter host name	Defines an access list filter for incoming messages.
Router(config-if)# netbios output-access-filter host name	Defines an access list filter for outgoing messages.

Configuring NetBIOS Access Filters Using a Byte Offset

To configure access filters you must do the following:

1. Assign a byte offset access list name.
2. Specify the direction of the message to be filtered on the interface.

Keep the following notes in mind while configuring access filters using a byte offset:

- When an access list entry has an offset plus the length of the pattern that is larger than the packet's length, the entry will not make a match for that packet.
- Because these access lists allow arbitrary byte offsets into packets, these access filters can have a significant impact on the amount of packets per second transiting across the bridge. They should be used only when situations absolutely dictate their use.

The NetBIOS byte offset access list contains a series of offsets and hexadecimal patterns with which to match byte offsets in NetBIOS packets. To assign a byte offset access list name, use the following command in global configuration mode:

Command	Purpose
Router(config)# netbios access-list bytes <i>name {permit deny} offset pattern</i>	Defines the byte offsets and patterns within NetBIOS messages to match with access list parameters.



Note

Using NetBIOS Byte Offset access filters disables the autonomous or fast switching of source-route bridging frames.

When filtering by byte offset, you can filter either incoming or outgoing messages on the interface. To specify the direction, use one of the following commands in interface configuration mode, as needed:

Command	Purpose
Router(config-if)# netbios input-access-filter bytes <i>name</i>	Specifies a byte-based access filter on incoming messages.
Router(config-if)# netbios output-access-filter bytes <i>name</i>	Specifies a byte-based access filter on outgoing messages.

Configuring Administrative Filters for Token Ring Traffic

Source-route bridges normally filter frames according to the routing information contained in the frame. That is, a bridge will not forward a frame back to its originating network segment or any other network segment that the frame has already traversed. This section describes how to configure another type of filter—the administrative filter.

Administrative filters can filter frames based on the following methods:

- Protocol type—IEEE 802 or Subnetwork Access Protocol (SNAP)
- Token Ring vendor code
- Source address
- Destination address

Whereas filtering by Token Ring address or vendor code causes no significant performance penalty, filtering by protocol type significantly affects performance. A list of SNAP (Ethernet) type codes is provided in the “Ethernet Type Codes” appendix in the *Cisco IOS Bridging and IBM Networking Command Reference* (Volume 1 of 2).

Filtering Frames by Protocol Type

You can configure administrative filters by protocol type by specifying protocol type codes in an access list. You then apply that access list to either IEEE 802.2 encapsulated packets or to SNAP-encapsulated packets on the appropriate interface.

The order in which you specify these elements affects the order in which the access conditions are checked. Each condition is tested in succession. A matching condition is then used to execute a permit or deny decision. If no conditions match, a deny decision is reached.



Note

If a single condition is to be denied, there must be an **access-list** command that permits everything as well, or all access is denied.

To filter frames by protocol type, use the following command in global configuration mode:

Command	Purpose
Router(config)# access-list <i>access-list-number</i> { permit deny } { <i>type-code</i> <i>wild-mask</i> <i>address mask</i> }	Creates an access list for filtering frames by protocol type.

You can filter IEEE 802-encapsulated packets on either input or output. The access list you specify is the one you created that includes the protocol type codes.

To enable filtering on input or output, use one of the following commands in interface configuration mode, as needed:

Command	Purpose
Router(config-if)# source-bridge input-lsap-list <i>access-list-number</i>	Enables filtering of IEEE 802-encapsulated packets on input by type code.
Router(config-if)# source-bridge output-lsap-list <i>access-list-number</i>	Enables filtering of IEEE 802-encapsulated packets on output by type code.

You can filter SNAP-encapsulated packets on either input or output. The access list you specify is the one you created that includes the protocol type codes.

To enable filtering on input or output, use one of the following commands in interface configuration mode, as needed:

Command	Purpose
Router(config-if)# source-bridge input-type-list <i>access-list-number</i>	Filters SNAP-encapsulated packets on input by type code.
Router(config-if)# source-bridge output-type-list <i>access-list-number</i>	Filters SNAP-encapsulated frames on output by type code.

Filtering Frames by Vendor Code

To configure administrative filters by vendor code or address, define access lists that look for Token Ring addresses or for particular vendor codes for administrative filtering. To do so, use the following command in global configuration mode:

Purpose	Command
Router(config)# access-list <i>access-list-number</i> { permit deny } <i>address</i> <i>mask</i>	Configures vendor code access lists.

Filtering Source Addresses

To configure filtering on IEEE 802 source addresses, assign an access list to a particular input interface for filtering the Token Ring or IEEE 802 source addresses. To do so, use the following command in interface configuration mode:

Command	Purpose
Router(config-if)# source-bridge input-address-list <i>access-list-number</i>	Enables filtering on IEEE 802 source addresses.

Filtering Destination Addresses

To configure filtering on IEEE 802 destination addresses, assign an access list to a particular output interface. To do so, use the following command in interface configuration mode:

Command	Purpose
Router(config-if)# source-bridge output-address-list <i>access-list-number</i>	Enables filtering on IEEE 802 destination addresses.

Configuring Access Expressions that Combine Administrative Filters

You can use access expressions to combine access filters to establish complex conditions under which bridged frames can enter or leave an interface. Using access expressions, you can achieve levels of control on the forwarding of frames that otherwise would be impossible when using only simple access filters. Access expressions are constructed from individual access lists that define administrative filters for the following fields in packets:

- LSAP and SNAP type codes
- MAC addresses
- NetBIOS station names
- NetBIOS arbitrary byte values



Note

For any given interface, an access expression cannot be used if an access list has been defined for a given direction. For example, if an input access list is defined for MAC addresses on an interface, no access expression can be specified for the input side of that interface.

In [Figure 31](#), two routers each connect a Token Ring to an FDDI backbone. On both Token Rings, SNA and NetBIOS bridging support is required. On Token Ring A, NetBIOS clients must communicate with any NetBIOS server off Token Ring B or any other, unpictured, router. However, the two 3174 cluster controllers off Token Ring A must only communicate with the one FEP off of Token Ring B, located at MAC address 0110.2222.3333.

Without access expressions, this scenario cannot be achieved. A filter on Router A that restricted access to only the FEP would also restrict access of the NetBIOS clients to the FEP. What is needed is an access *expression* that would state “If it is a NetBIOS frame, pass through, but if it is an SNA frame, only allow access to address 0110.2222.3333.”

Figure 31 Access Expression Example

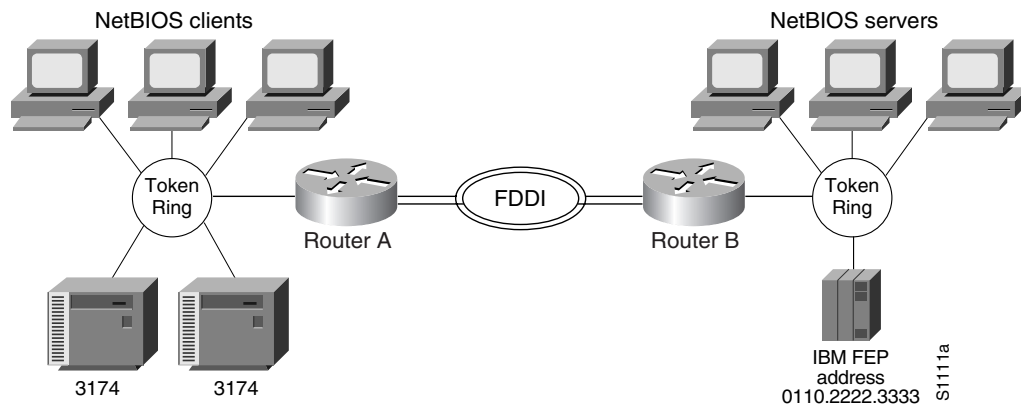

Note

Using access-expressions that combine access filters disables the autonomous or fast switching of source-route bridging frames.

Configuring Access Expressions

To configure an access expression perform the following tasks:

- Design the access expression.
- Configure the access lists used by the expression.
- Configure the access expression into the router.

When designing an access expression, you must create some phrase that indicates, in its entirety, all the frames that will *pass* the access expression. This access expression is designed to apply on frames coming from the Token Ring interface on Router A in [Figure 31](#):

“Pass the frame if it is a NetBIOS frame or if it is an SNA frame destined to address 0110.2222.3333.”

In Boolean form, this phrase can be written as follows:

“Pass if ‘NetBIOS or (SNA and destined to 0110.2222.3333).’”

The preceding statement requires three access lists to be configured:

- An access list that passes a frame if it is a NetBIOS frame (SAP = 0xF0F0)
- An access list that passes a frame if it is an SNA frame (SAP = 0x0404)
- An access list that passes a MAC address of 0110.2222.3333

The following configuration allows for all these conditions:

```

! Access list 201 passes NetBIOS frames (command or response)
access-list 201 permit 0xF0F0 0x0001
!
access-list 202 permit 0x0404 0x0001 ! Permits SNA frames (command or response)
access-list 202 permit 0x0004 0x0001 ! Permits SNA Explorers with NULL DSAP
!
! Access list 701 will permit the FEP MAC address
! of 0110.2222.3333
access-list 701 permit 0110.2222.3333

```

The 0x0001 mask allows command and response frames to pass equally.

To apply the access expression to the appropriate interface, enter the following command in interface configuration mode:

Command	Purpose
Router(config-if)# access-expression {in out} <i>expression</i>	Defines a per-interface access expression.

Optimizing Access Expressions

It is possible to combine access expressions. Suppose you wanted to send SNA traffic through to a single address, but allow other traffic through the router without restriction. The phrase could be written as follows:

“Allow access if the frame is not an SNA frame, or if it is going to host 0110.2222.3333.”

More tersely, this would be:

“Not SNA or destined to 0110.2222.3333.”

The access lists defined in the previous section create the following configuration:

```

interface tokenring 0
 access-expression in ~lsap(202) | dmac(701)
!
access-list 202 permit 0x0404 0x0001 ! Permits SNA frames (command or response)
access-list 202 permit 0x0004 0x0001 ! Permits SNA Explorers with NULL DSAP
!
! Access list 701 will permit the FEP MAC address
! of 0110.2222.3333
access-list 701 permit 0110.2222.3333

```

This is a better and simpler access list than the one originally introduced and will probably result in better run-time execution as a result. Therefore, it is best to simplify your access expressions as much as possible before configuring them into the Cisco IOS software.



Note

An “access-expression” type filter cannot exist with a “source-bridge” type filter on the same interface. The two types of filters are mutually exclusive.

Altering Access Lists Used in Access Expressions

Because access expressions are composed of access lists, special care must be taken when deleting and adding access lists that are referenced in these access expressions.

If an access list that is referenced in an access expression is deleted, the access expression merely ignores the deleted access list. However, if you want to redefine an access list, you can create a new access list with the appropriate definition and use the same name as the old access list. The newly defined access list replaces the old one of the same name.

For example, if you want to redefine the NetBIOS access list named MIS that was used in the preceding example, you would use the following sequence of configuration commands:

```
! Replace the NetBIOS access list
interface tokenring 0
 access-expression in (smac(701) & netbios-host(accept))
 no netbios access-list host accept permit CISCO*
```

Tuning the SRB Network Task List

The following sections describe how to configure features that enhance network performance by reducing the number of packets that traverse the backbone network:

- [Enabling or Disabling the Source-Route Fast-Switching Cache, page 116](#)
- [Enabling or Disabling the Source-Route Autonomous-Switching Cache, page 117](#)
- [Enabling or Disabling the SSE, page 117](#)
- [Establishing the Connection Timeout Interval, page 117](#)
- [Optimizing Explorer Processing, page 118](#)
- [Configuring Proxy Explorers, page 119](#)



Note

In some situations, you might discover that default settings for LLC2 configurations are not acceptable. In such a case, you can configure LLC2 for optimal use. The chapter “Configuring LLC2 and SDLC Parameters” in this publication describes how you can use them to optimize your network performance.

Enabling or Disabling the Source-Route Fast-Switching Cache

Rather than processing packets at the process level, the fast-switching feature enables the Cisco IOS software to process packets at the interrupt level. Each packet is transferred from the input interface to the output interface without copying the entire packet to main system memory. Fast switching allows for faster implementations of local SRB between 4/16-MB Token Ring cards in the same router, or between two routers using the 4/16-Mb Token Ring cards and direct encapsulation.

By default, fast-switching software is enabled when SRB is enabled. To enable or disable source-route fast-switching, use one of the following commands in interface configuration mode, as needed:

Command	Purpose
Router(config-if)# source-bridge route-cache	Enables fast-switching.
Router(config-if)# no source-bridge route-cache	Disables fast-switching.



Note

Using either NetBIOS Byte Offset access filters or access expressions that combine access filters disables the fast switching of source-route bridging frames.

Enabling or Disabling the Source-Route Autonomous-Switching Cache

Autonomous switching is a feature that enables the Cisco IOS software to send packets from the input ciscoBus card to the output ciscoBus card without any involvement on the part of the router processor.

Autonomous switching is available for local SRB between ciscoBus Token Ring (CTR) cards in the same router. Autonomous switching provides higher switching rates than does fast switching between 4/16-Mb Token Ring cards. Autonomous switching works for both two-port bridges and multiport bridges that use ciscoBus Token Ring cards.

In a virtual ring that includes both ciscoBus Token Ring and 4/16-Mb Token Ring interfaces, frames that flow from one CTR interface to another are autonomously switched, and the remainder of the frames are fast switched. The switching that occurs on the CTR interface takes advantage of the high-speed ciscoBus controller processor.

To enable or disable source-route autonomous switching, use one of the following commands in interface configuration mode, as needed:

Command	Purpose
Router(config-if)# source-bridge route-cache cbus	Enables autonomous switching.
Router(config-if)# no source-bridge route-cache cbus	Disables autonomous switching.



Note

Using either NetBIOS Byte Offset access filters or access-expressions that combine access filters disables the autonomous switching of SRB frames.

Enabling or Disabling the SSE

The Silicon Switch Engine (SSE) acts as a programmable cache to speed the switching of packets. To enable or disable the SSE, use one of the following commands in interface configuration mode, as needed:

Command	Purpose
Router(config-if)# source-bridge route-cache sse	Enables the SSE function.
Router(config-if)# no source-bridge route-cache sse	Disables the SSE function.

Establishing the Connection Timeout Interval

It might be necessary to adjust timeout intervals in a complex topology such as a large multihop WAN with virtual rings or satellite links. The timeout interval is used when a connection to a remote peer is attempted. If the timeout interval expires before a response is received, the connection attempt is aborted.

To set the connection timeout interval, use the following command in global configuration mode:

Command	Purpose
Router(config)# source-bridge connection-timeout <i>seconds</i>	Sets the connection timeout interval.

Optimizing Explorer Processing

Efficient explorer processing is vital to the operation of SRB. The default configuration is satisfactory for most situations. However, there might be circumstances that create unexpected broadcast storms. You can optimize the handling of explorer frames, thus reducing processor overhead and increasing explorer packet throughput. Optimizing explorer processing enables the router to perform substantially better during explorer broadcast storms.

In networks with redundant topologies—two or more routers connected to the same set of Token Rings and doing source-route bridging—a station on one Token Ring trying to get to a station on another Token Ring may choose a less than optimal route through unnecessary routers, causing explorer storms due to excessive forwarding of explorer frames. For example, in the redundant topology example shown in [Figure 32](#), if Station X on Token Ring 1 attempts to get to Station Z on Token Ring 4 by going through Router A, Token Ring 2, and Router B—a less than optimal route, excessive forwarding of explorer frames may cause explorer storms.

Figure 32 Controlling Explorer Storms in Redundant Network Topologies

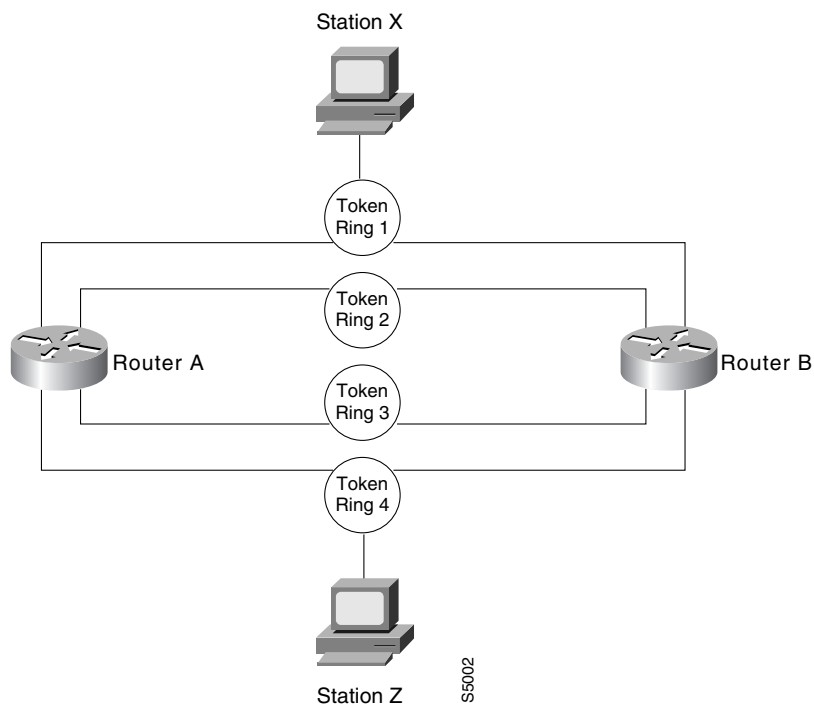

The **source-bridge explorer-dup-ARE-filter** command can be used to reduce explorer traffic by filtering explorer frames.

To optimize explorer processing, use one of the following commands in global configuration mode, as needed:

Command	Purpose
Router(config)# source-bridge explorerq-depth <i>depth</i>	Sets the maximum explorer queue depth.
Router(config)# source-bridge explorer-dup-ARE-filter	Prevents explorer storms in redundant network topologies by filtering explorers that have already been forwarded once.
Router(config)# source-bridge explorer-maxrate <i>maxrate</i>	Sets the maximum byte rate of explorers per ring.

You must also disable explorer fast-switching which is, by default, enabled. To disable explorer fast-switching, use the following command in global configuration mode:

Command	Purpose
Router(config)# no source-bridge explorer-fastswitch	Disables explorer fast switching.

To enable explorer fast-switching after it has been disabled, use the following command in global configuration mode:

Command	Purpose
Router(config)# source-bridge explorer-fastswitch	Enables explorer fast switching.

Configuring Proxy Explorers

You can use the proxy explorers feature to limit the amount of explorer traffic propagating through the source-bridge network.

To configure proxy explorers, use the following command in interface configuration mode:

Command	Purpose
Router(config-if)# source-bridge proxy-explorer	Enables the interface to respond to any explorer packets that meet certain conditions necessary for a proxy response to occur.

The Cisco IOS software does not propagate proxy responses for a station. Instead, the software obtains the RIF path from the RIF cache, changes the explorer to a specific frame, and forwards this frame to the destination. If a response is not received before the validation timer expires, the RIF entry is marked as invalid. The invalid RIF entry is flushed from the cache table when another explorer for this station is received, and an explorer is forwarded to discover a path to this station.

Establishing SRB Interoperability with Specific Token Ring Implementations

This section describes how you can establish interoperability between routers and specific Token Ring implementations. It includes the following sections:

- [Establishing SRB Interoperability with TI MAC Firmware, page 120](#)
- [Reporting Spurious Frame-Copied Errors, page 120](#)

Establishing SRB Interoperability with TI MAC Firmware

You can use a workaround to establish interoperability with Texas Instruments MAC firmware.

There is a known defect in earlier versions of the Texas Instruments Token Ring MAC firmware. This implementation is used by Proteon, Apollo, and IBM RTs. A host using a MAC address whose first two bytes are zeros (such as a Cisco router) will not properly communicate with hosts using that version of Texas Instruments firmware.

There are two solutions. The first involves installing a static RIF entry for every faulty node with which the router communicates. If there are many such nodes on the ring, this may not be practical.

You also can set the MAC address of our Token Ring to a value that works around the problem. Resetting the MAC address forces the use of a different MAC address on the specified interface, thereby avoiding the TI MAC firmware problem. However, you must ensure that no other host on the network is using that MAC address.

To reset the MAC address, use the following command in interface configuration mode:

Command	Purpose
Router(config-if)# mac-address <i>ieee-address</i>	Resets the MAC address of the Token Ring interface to a value that provides a workaround to a problem in Texas Instruments Token Ring MAC firmware.

Reporting Spurious Frame-Copied Errors

An IBM 3174 cluster controller can be configured to report frame-copied errors to IBM LAN Network Manager software. These errors indicate that another host is responding to the MAC address of the 3174 cluster controller. Both the 3174 cluster controller and the IBM LAN Network Manager software can be configured to ignore frame-copied errors.

Monitoring and Maintaining the SRB Network

You can display a variety of information about the SRB network. To display the information you require, use one of the following commands in EXEC mode, as needed:

Command	Purpose
Router# show access-expression [<i>begin</i> <i>exclude</i> <i>include</i>]	Displays the defined input and output access list expressions.
Router# show controllers token	Displays internal state information about the Token Ring interfaces in the system.
Router# show interfaces tokenring	Provides high-level statistics for a particular interface.

Command	Purpose
Router# show interfaces	Provides high-level statistics about the state of source bridging for a particular interface.
Router# show lnm bridge	Displays all currently configured bridges and all parameters that are related to the bridge as a whole and not to one of its interfaces.
Router# show lnm config	Displays the logical (multiport bridge) configuration of the Cisco IOS software.
Router# show lnm interface [type number]	Displays all LNM-relevant information about a specific interface.
Router# show lnm ring [ring-number]	Displays all LNM-relevant information about a specific ring number.
Router# show lnm station [address]	Displays all LNM-relevant information about a specific station or about all known stations on the ring.
Router# show local-ack	Shows the current state of any current local acknowledgment for both LLC2 and SDLLC connections.
Router# show netbios-cache	Displays the contents of the NetBIOS cache.
Router# show rif	Displays the contents of the RIF cache.
Router(config)# show source-bridge [interface]	Displays the current source bridge configuration and miscellaneous statistics.
Router# show span	Displays the spanning-tree topology for the router.
Router# show sse summary	Displays a summary of Silicon Switch Processor (SSP) statistics.

To maintain the SRB network, use one of the following commands in privileged EXEC mode, as needed:

Command	Purpose
Router# clear netbios-cache	Clears the entries of all dynamically learned NetBIOS names.
Router# clear rif-cache	Clears the entire RIF cache.
Router# clear source-bridge	Clears the SRB statistical counters.
Router# clear sse	Reinitializes the SSP on the Cisco 7000 series.

In addition to the EXEC-mode commands to maintain the SRB network, you can use the following command in global configuration mode:

Command	Purpose
Router(config)# source-bridge tcp-queue-max <i>number</i>	Limits the size of the backup queue for RSRB to control the number of packets that can wait for transmission to a remote ring before they are thrown away.

SRB Configuration Examples

The following sections provide SRB configuration examples:

- [Basic SRB with Spanning-Tree Explorers Example, page 122](#)
- [SRB with Automatic Spanning-Tree Function Configuration Example, page 123](#)
- [Optimized Explorer Processing Configuration Example, page 123](#)

- [SRB-Only Example, page 123](#)
- [SRB and Routing Certain Protocols Example, page 124](#)
- [Multiport SRB Example, page 125](#)
- [SRB with Multiple Virtual Ring Groups Example, page 126](#)
- [SRB over FDDI Configuration Examples, page 127](#)
- [SRB over FDDI Fast-Switching Example, page 127](#)
- [SRB over Frame Relay Configuration Example, page 128](#)
- [Adding a Static RIF Cache Entry Example, page 129](#)
- [Adding a Static RIF Cache Entry for a Two-Hop Path Example, page 130](#)
- [SR/TLB for a Simple Network Example, page 130](#)
- [SR/TLB with Access Filtering Example, page 132](#)
- [NetBIOS Support with a Static NetBIOS Cache Entry Example, page 133](#)
- [LNM for a Simple Network Example, page 134](#)
- [LNM for a More Complex Network Example, page 135](#)
- [NetBIOS Access Filters Example, page 136](#)
- [Filtering Bridged Token Ring Packets to IBM Machines Example, page 137](#)
- [Administrative Access Filters—Filtering SNAP Frames on Output Example, page 138](#)
- [Creating Access Filters Example, page 139](#)
- [Access Filters Example, page 140](#)
- [Fast-Switching Example, page 140](#)
- [Autonomous Switching Example, page 141](#)
- [Back-to-Back Routers ATM Configuration Example, page 141](#)
- [Single ATM PVC and Single Virtual Ring Per Router Configuration Example, page 142](#)
- [Multiple ATM PVCs and Multiple Virtual Rings on One Router Configuration Example, page 143](#)
- [Multiple ATM PVCs with a Single Virtual Ring on the Router Configuration Example, page 144](#)

Basic SRB with Spanning-Tree Explorers Example

Figure 33 illustrates a simple two-port bridge configuration. Token Rings 129 and 130 are connected through the router.

Figure 33 *Dual-Port Source-Route Bridge Configuration*



The example that follows routes IP, but source-route bridges all other protocols using spanning-tree explorers:

```
interface tokenring 0
ip address 131.108.129.2 255.255.255.0
source-bridge 129 1 130
```

```

source-bridge spanning
multiring all
!
interface tokenring 1
ip address 131.108.130.2 255.255.255.0
source-bridge 130 1 129
source-bridge spanning
! use RIFs, as necessary, with IP routing software
multiring all

```

SRB with Automatic Spanning-Tree Function Configuration Example

The following example of a Cisco series 7000 router configuration illustrates how to enable the automatic spanning-tree function on an SRB network:

```

source-bridge ring-group 100

interface tokenring 0/0
no ip address
ring-speed 16
multiring all
source-bridge active 1 10 100
source-bridge spanning 1
!
interface tokenring 0/1
no ip address
ring-speed 16
multiring all
source-bridge active 2 10 100
source-bridge spanning 1
!
bridge 1 protocol ibm

```

Optimized Explorer Processing Configuration Example

The following configuration example improves the handling of explorer frames, enabling the Cisco IOS software to perform substantially better during explorer broadcast storms. In this configuration, the maximum byte rate of explorers is set to 100000.

```

source-bridge explorer-maxrate 100000
source-bridge explorerQ-depth 100
no source-bridge explorer-fastswitch

```

SRB-Only Example

The following example shows that all protocols are bridged, including IP. Because IP is being bridged, the system has only one IP address.

```

no ip routing
!
interface tokenring 0
ip address 131.108.129.2 255.255.255.0
source-bridge 129 1 130
source-bridge spanning
!
interface tokenring 1
ip address 131.108.129.2 255.255.255.0

```

```

source-bridge 130 1 129
source-bridge spanning
!
interface ethernet 0
ip address 131.108.129.2 255.255.255.0

```

SRB and Routing Certain Protocols Example

In the following configuration, IP, XNS, and IPX are routed, while all other protocols are bridged between rings. While not strictly necessary, the Novell IPX and XNS network numbers are set consistently with the IP subnetwork numbers. This makes the network easier to maintain.

```

xns routing 0000.0C00.02C3
!
novell routing 0000.0C00.02C3
!
interface tokenring 0
ip address 131.108.129.2 255.255.255.0
xns network 129
novell network 129
source-bridge 129 1 130
source-bridge spanning
multiring all
!
interface tokenring 1
ip address 131.108.130.2 255.255.255.0
xns network 130
novell network 130
source-bridge 130 1 129
source-bridge spanning
multiring all
!
interface ethernet 0
ip address 131.108.2.68 255.255.255.0
xns network 2
novell network 2

```

Multiport SRB Example

Figure 34 shows an example configuration of a four-port Token Ring source-route bridge. Rings 1000, 1001, 1002, and 1003 are all source-route bridged to each other across ring group 7.

Figure 34 Four-Port Source-Route Bridge

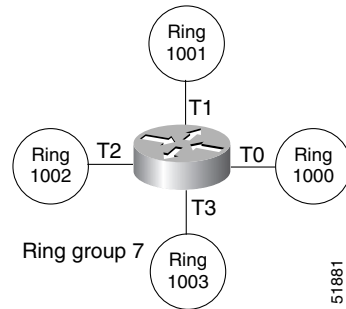

The following is a sample configuration file:

```
source-bridge ring-group 7
!
interface tokenring 0
 source-bridge 1000 1 7
 source-bridge spanning
!
interface tokenring 1
 source-bridge 1001 1 7
 source-bridge spanning
!
interface tokenring 2
 source-bridge 1002 1 7
 source-bridge spanning
!
interface tokenring 3
 source-bridge 1003 1 7
 source-bridge spanning
```

SRB with Multiple Virtual Ring Groups Example

Two virtual ring groups can only be connected through an actual Token Ring. Figure 35 shows virtual rings 100 and 200 connected through Token Ring 3.

Figure 35 Two Virtual Rings Connected by an Actual Token Ring

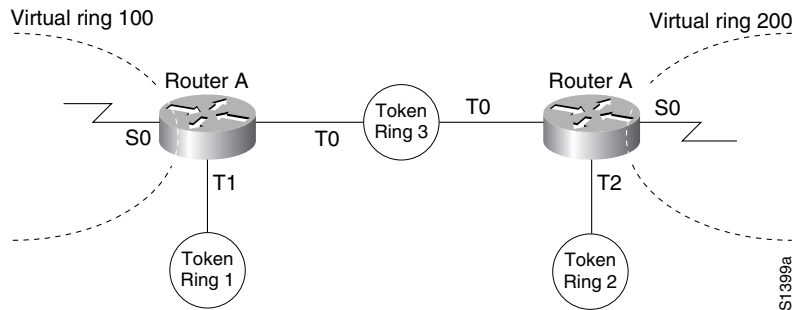

Configuration for Router A

```
source-bridge ring-group 100
!
interface tokenring 0
 source-bridge 3 4 100
 source-bridge spanning
!
interface tokenring 1
 source-bridge 1 4 100
 source-bridge spanning
```

Configuration for Router B

```
source-bridge ring-group 200
!
interface tokenring 0
 source-bridge 3 1 200
 source-bridge spanning
!
interface tokenring 2
 source-bridge 2 1 200
 source-bridge spanning
```

SRB over FDDI Configuration Examples

The following examples show the configuration for SRB over FDDI as illustrated in [Figure 36](#).

Figure 36 SRB over FDDI Configuration

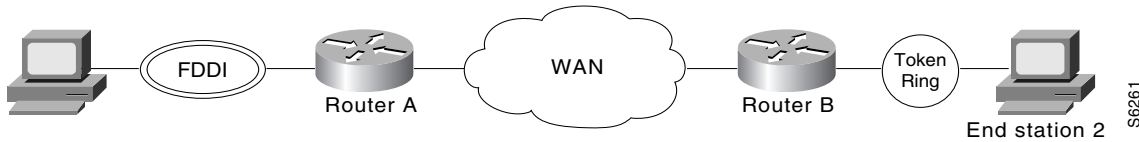

Router A

```
dlsw local-peer peer-id 132.11.11.2
dlsw remote-peer 0 tcp 132.11.11.3
interface Fddi0
 no ip address
 multiring all
 source-bridge 26 1 10
 source-bridge spanning
```

Router B

```
dlsw local-peer peer-id 132.11.11.2
dlsw remote-peer 0 tcp 132.11.11.3
interface TokenRing0
 no ip address
 ring-speed 16
 multiring all
 source-bridge 25 1 10
 source-bridge spanning
```

SRB over FDDI Fast-Switching Example

The following example shows SRB over FDDI fast-switching:

```
interface fddi 2/0
 source-bridge 1 10 2
 source-bridge spanning
 source-bridge route-cache
 multiring ip
```

SRB over Frame Relay Configuration Example

Figure 37 illustrates a network with the following characteristics:

- Virtual Ring Number of Router A = 100
- Virtual Ring Number of FRAD B = 200
- Virtual Ring Number of FRAD C = 300
- DLCI number for PVC between Router A and FRAD B = 30
- DLCI number for PVC between Router A and FRAD C = 31

Figure 37 FRAD Using SRB over Frame Relay to Connect to a Cisco Router

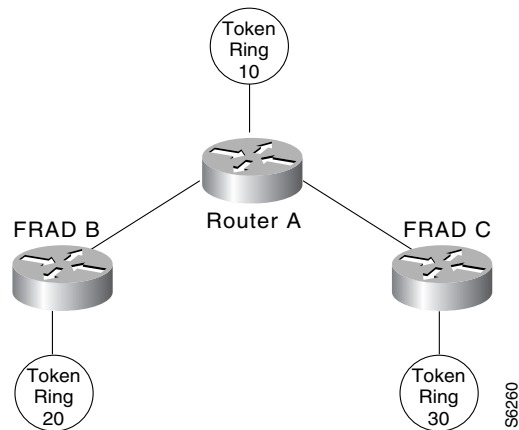

In this example, we configure a new option, **conserve-ring**, on the **source-bridge** interface configuration command. When this option is configured, the SRB software does not add the ring number associated with the Frame Relay PVC (the partner's virtual ring) to outbound explorer frames. This option is permitted for Frame Relay subinterfaces only.

This approach does not require a separate ring number per DLCI. The router configures the partner FRAD's virtual ring number as the ring number for the PVC. FRAD B configures its virtual ring as 200 and the ring for the PVC as 100. FRAD C configures its virtual ring as 300 and the ring for the PVC as 100.

Configuration of Router A

```
source-bridge ring-group 100
!
interface Serial1
  encapsulation frame-relay
!
interface Serial1.1 point-to-point
  frame-relay interface-dlci 30 ietf
  source-bridge 200 1 100 conserve-ring
  source-bridge spanning
!
interface Serial1.2 point-to-point
  frame-relay interface-dlci 31 ietf
  source-bridge 300 1 100 conserve-ring
  source-bridge spanning
!
interface TokenRing0
  source-bridge 500 1 100
```

Configuration on Router B

```

source-bridge ring-group 200
!
interface Serial0
  encapsulation frame-relay
!
interface Serial0.30 point-to-point
  frame-relay interface-dlci 30 ietf
  source-bridge 100 1 200 conserve-ring
  source-bridge spanning
!
interface TokenRing0
  source-bridge 600 1 200

```

Configuration on Router C

```

source-bridge ring-group 300
!
interface Serial0
  encapsulation frame-relay
!
interface Serial0.31 point-to-point
  frame-relay interface-dlci 31 ietf
  source-bridge 100 1 300 conserve-ring
  source-bridge spanning
!
interface TokenRing0
  source-bridge 900 1 300

```

Adding a Static RIF Cache Entry Example

In the example configuration in [Figure 38](#), the path between rings 8 and 9 connected via Bridge 1 is described by the route descriptor 0081.0090. The full RIF, including the route control field, is 0630.0081.0090.

Figure 38 Assigning a RIF to a Source-Route Bridge

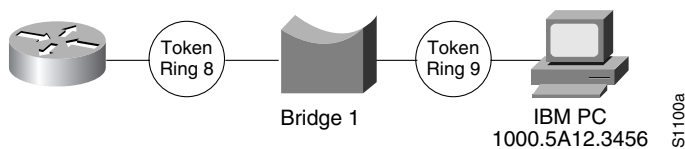

The static RIF entry would be submitted to the router on the left as follows:

```

rif 1000.5A12.3456 0630.0081.0090

```

Adding a Static RIF Cache Entry for a Two-Hop Path Example

In [Figure 39](#), assume that a datagram was sent from a router on ring 21 (15 hexadecimal) across Bridge 5 to ring 256 (100 hexadecimal), then across Bridge 10 (A hexadecimal) to ring 1365 (555 hexadecimal) for delivery to a destination host on that ring.

Figure 39 Assigning a RIF to a Two-Hop Path

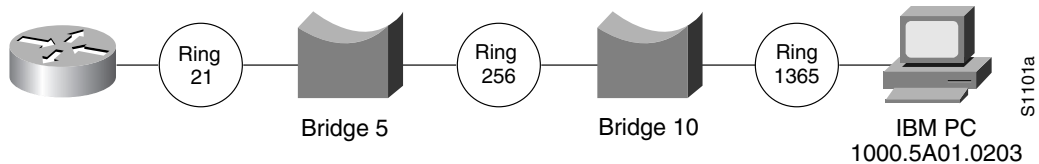

The RIF in the router on the left describing this two-hop path is 0830.0155.100a.5550 and is entered as follows:

```
rif 1000.5A01.0203 0830.0155.100a.5550
```

SR/TLB for a Simple Network Example

In the simple example illustrated in [Figure 40](#), a four-port router with two Ethernets and two Token Rings is used to connect transparent bridging on the Ethernets to SRB on the Token Rings.

Figure 40 Example of a Simple SR/TLB Configuration

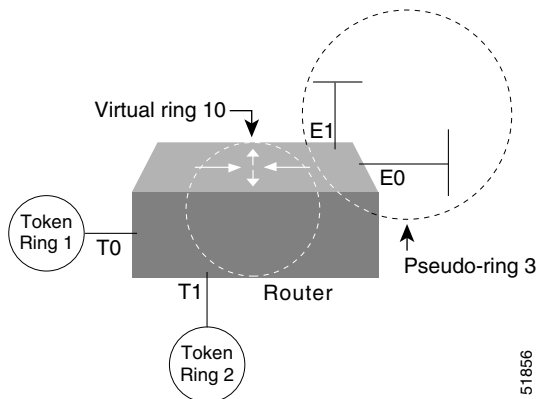

Assume that the following configuration for SRB and transparent bridging existed before you wanted to enable SR/TLB:

```
interface tokenring 0
  source-bridge 1 1 2
  !
interface tokenring 1
  source-bridge 2 1 1
  !
interface ethernet 0
  bridge-group 1
  !
interface ethernet 1
  bridge-group 1
  !
bridge 1 protocol dec
```

To enable SR/TLB, one aspect of this configuration must change immediately—a third ring must be configured. Before SR/TLB, the two Token Ring interfaces were communicating with two-port local source-route bridging; after SR/TLB, these two interfaces must be reconfigured to communicate through a virtual ring, as follows:

```
source-bridge ring-group 10
!
interface tokenring 0
 source-bridge 1 1 10
!
interface tokenring 1
 source-bridge 2 1 10
!
interface ethernet 0
 bridge-group 1
!
interface ethernet 1
 bridge-group 1
!
bridge 1 protocol dec
```

Now you are ready to determine two things:

- A ring number for the pseudo-ring that is unique throughout the source-route bridged network. For the preceding example configuration, use the number 3.
- A bridge number for the path to the pseudo-ring. For the preceding example configuration, use the number 1.

Once you have determined the ring number and the bridge number, you can add the **source-bridge transparent** command to the file, including these two values as parameters for the command. The following partial configuration includes this **source-bridge transparent** entry:

```
source-bridge ring-group 10
source-bridge transparent 10 3 1 1
!
interface tokenring 0
 source-bridge 1 1 10
!
interface tokenring 1
 source-bridge 2 1 10
!
interface ethernet 0
 bridge-group 1
!
interface ethernet 1
 bridge-group 1
!
bridge 1 protocol dec
```

SR/TLB with Access Filtering Example

In the example shown in [Figure 41](#), you want to connect only a single machine, Host E, on an Ethernet to a single machine, Host R, on the Token Ring.

Figure 41 Example of a Bit-Swapped Address

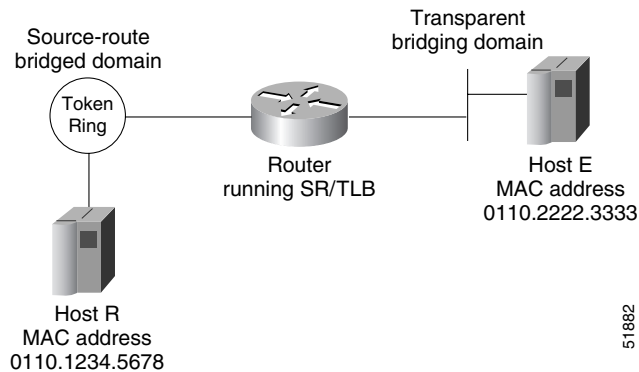

You want to allow only these two machines to communicate across the router. Therefore, you might create the following configuration to restrict the access. However, this configuration will not work, as explained in the paragraph following the sample configuration file.



Note

For readability, the commands that control bridging are not shown here, just the commands that control the filtering.

```
interface tokenring 0
  access-expression output smac(701)
!
interface ethernet 0
  bridge-group 1 input-address-list 701
!
access-list 701 permit 0110.2222.3333
```

The command for the Token Ring interface specifies that the access list 701 be applied on the source address of frames going out to the Token Ring, and the command for the Ethernet interface specifies that this access list be applied on the source address frames entering the interface from Ethernet. This would work if both interfaces used the same bit ordering, but Token Rings and Ethernets use opposite (swapped) bit orderings in their addresses in relationship to each other. Therefore, the address of Host E on the Token Ring is not 0110.2222.3333, but rather 8008.4444.cccc, resulting in the following configuration. The following configuration is better. This example shows that access lists for Token Ring and Ethernet should be kept completely separate from each other.

```
interface tokenring 0
  source-bridge input-address-list 702
!
interface ethernet 0
  bridge-group 1 input-address-list 701
!
access-list 701 permit 0110.2222.3333
!
access-list 702 permit 0110.1234.5678
```

NetBIOS Support with a Static NetBIOS Cache Entry Example

Figure 42 shows a NetBIOS client on a Token Ring connected through a cloud to a NetBIOS server on another Token Ring.

Figure 42 Specifying a Static Entry

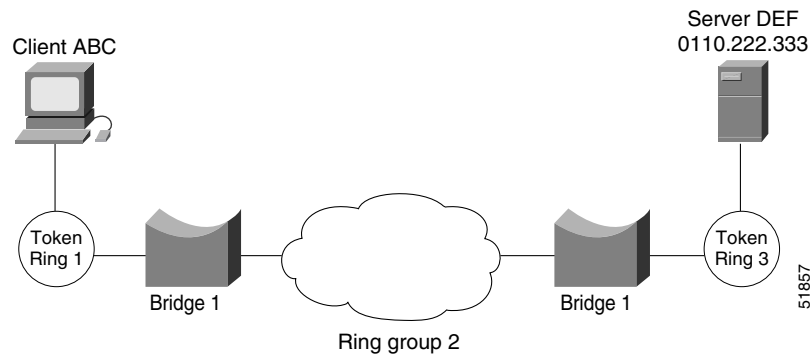

In Figure 42, a static entry is created in the router attached to ring 1 on the client side of the ring group. The static entry is to the server DEF, which is reached through the router attached to ring 3. If server DEF has the MAC address 0110.2222.3333, the configuration for the static entry on the client side is as follows:

```
rif 0110.2222.3333 0630.0021.0030 ring-group 2
netbios name-cache 0110.2222.3333 DEF ring-group 2
```

LNМ for a Simple Network Example

Figure 43 shows a router with two Token Rings configured as a local source-route bridge.

Figure 43 Router with Two Token Rings Configured as a Local Source-Route Bridge

Physical configuration



Logical configuration

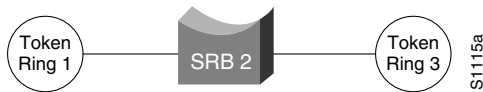

The associated configuration file follows:

```
interface tokenring 0
 source-bridge 1 2 3
!
interface tokenring 1
 source-bridge 3 2 1
```

The **show lnm config** command displays the logical configuration of this bridge, including the LNM configuration information that needs to be entered at the LNM Station. A sample **show lnm config** display follows:

```
Wayfarer# show lnm config

Bridge(s) currently configured:
From   ring 001, address 0000.3000.abc4
Across bridge 002
To     ring 003, address 0000.3000.5735
```

In this example, the MAC addresses 0000.3000.abc4 and 000.3000.5735 must be configured as adapter addresses at the LNM Station.

LNМ for a More Complex Network Example

Figure 44 shows a router with three Token Rings configured as a multiport bridge, thus employing the concept of the virtual ring.

Figure 44 Router with Three Token Rings Configured as a Multiport Bridge

Physical configuration

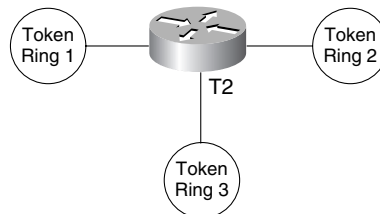

Logical configuration

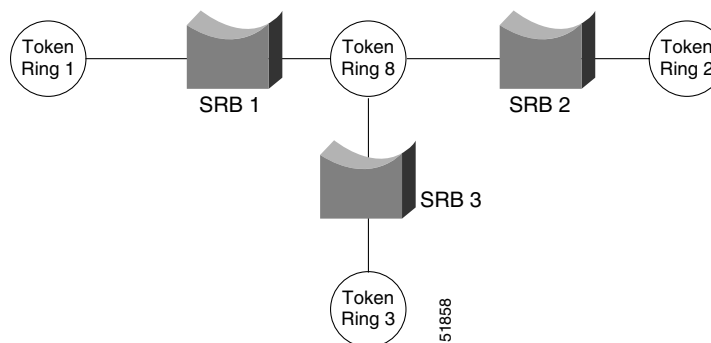

The associated configuration file follows.

```
source-bridge ring-group 8
!
interface tokenring 0
 source-bridge 1 1 8
!
interface tokenring 1
 source-bridge 2 2 8
!
interface tokenring 2
 source-bridge 3 3 8
```

The **show lnm config** command displays the logical configuration of this bridge, including all the pertinent information for configuring this router into LNM:

```
Wayfarer# show lnm config
```

```
Bridge(s) currently configured:
```

```
From    ring 001, address 0000.0028.abcd
Across  bridge 001
To      ring 008, address 4000.0028.abcd

From    ring 002, address 0000.3000.abc4
Across  bridge 002
To      ring 008, address 4000.3000.abc4
```

```

From      ring 003, address 0000.3000.5735
Across    bridge 003
To        ring 008, address 4000.3000.5735

```

In this example, six station definitions must be entered at the LNM Station, one for each of the MAC addresses listed in this sample **show lnm config** display.

NetBIOS Access Filters Example

The following command permits packets that include the station name ABCD to pass through the router, but denies passage to packets that do not include the station name ABCD:

```
netbios access-list host marketing permit ABCD
```

The following command specifies a prefix where the pattern matches any name beginning with the characters DEFG. Note that the string DEFG itself is included in this condition.

```
netbios access-list host marketing deny DEFG*
```

The following command permits any station name with the letter W as the first character and the letter Y as the third character in the name. The second and fourth letters in the name can be any character. This example would allow stations named WXYZ and WAYB; however, stations named WY and WXY would not be included in this statement, because the question mark must match some specific character in the name.

```
netbios access-list host marketing permit W?Y?
```

The following command illustrates how to combine wildcard characters:

```
netbios access-list host marketing deny AC?*
```

The command specifies that the marketing list deny any name beginning with AC that is at least three characters in length (the question mark would match any third character). The string ACBD and ACB would match, but the string AC would not.

The following command removes the entire marketing NetBIOS access list.

```
no netbios access-list host marketing
```

To remove single entries from the list, use a command such as the following:

```
no netbios access-list host marketing deny AC?*
```

This example removes only the list that filters station names with the letters AC at the beginning of the name.

Access lists are scanned in order. In the following example, the first list denies all entries beginning with the letters ABC, including one named ABCD. This voids the second command, because the entry permitting a name with ABCD comes after the entry denying it.

```
netbios access-list host marketing deny ABC*
netbios access-list host marketing permit ABCD
```

Filtering Bridged Token Ring Packets to IBM Machines Example

The example in Figure 45 disallows the bridging of Token Ring packets to all IBM workstations on Token Ring 1.

Figure 45 Router Filtering Bridged Token Ring Packets to IBM Machines

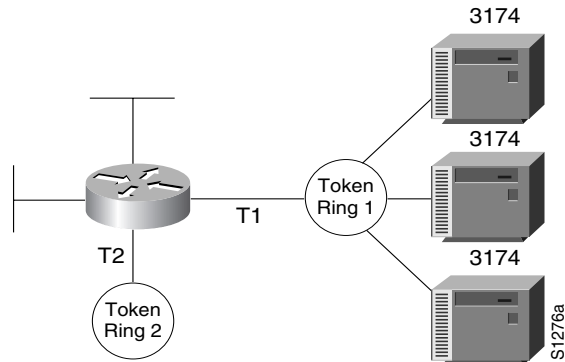

This example assumes that all hosts on Token Ring 1 have Token Ring addresses with the vendor code 1000.5A00.0000. The first line of the access list denies access to all IBM workstations, while the second line permits everything else. The access list is assigned to the input side of Token Ring 1.

```
! deny access to all IBM workstations
access-list 700 deny 1000.5A00.0000 8000.00FF.FFFF
! permit all other traffic
access-list 700 permit 0000.0000.0000 FFFF.FFFF.FFFF
!
interface token ring 1
! apply access list 700 to the input side of Token Ring 1
source-bridge input-address-list 700
```

Administrative Access Filters—Filtering SNAP Frames on Output Example

Figure 46 shows a router connecting four Token Rings.

Figure 46 Router Filtering SNAP Frames on Output

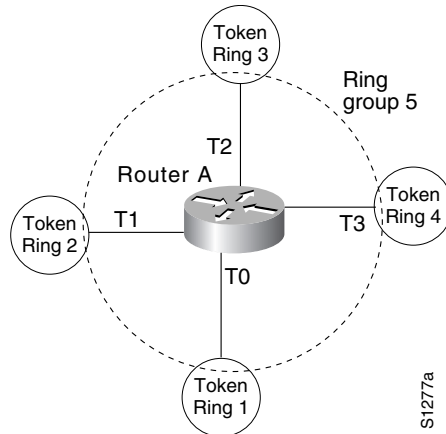

The following example allows only AppleTalk Phase 2 packets to be source-route bridged between Token Rings 0 and 1, and allows Novell packets only to be source-route bridged between Token Rings 2 and 3.

```

source-bridge ring-group 5
!
interface tokenring 0
 ip address 131.108.1.1 255.255.255.0
 source-bridge 1000 1 5
 source-bridge spanning
 source-bridge input-type-list 202
!
interface tokenring 1
 ip address 131.108.11.1 255.255.255.0
 source-bridge 1001 1 5
 source-bridge spanning
 source-bridge input-type-list 202
!
interface tokenring 2
 ip address 131.108.101.1 255.255.255.0
 source-bridge 1002 1 5
 source-bridge spanning
 source-bridge input-lsap-list 203
!
interface tokenring 3
 ip address 131.108.111.1 255.255.255.0
 source-bridge 1003 1 5
 source-bridge spanning
 source-bridge input-lsap-list 203
!
! SNAP type code filtering
! permit ATp2 data (0x809B)
! permit ATp2 AARP (0x80F3)
access-list 202 permit 0x809B 0x0000
access-list 202 permit 0x80F3 0x0000
access-list 202 deny 0x0000 0xFFFF
!
!

```

```

! LSAP filtering
! permit IPX (0xE0E0)
access-list 203 permit 0xE0E0 0x0101
access-list 203 deny 0x0000 0xFFFF

```

**Note**

It is not necessary to check for an LSAP of 0xAAAA when filtering SNAP-encapsulated AppleTalk packets, because for source-route bridging, the use of type filters implies SNAP encapsulation.

Creating Access Filters Example

In math, you have the following:

$$3 \times 4 + 2 = 14 \text{ but } 3 \times (4 + 2) = 18$$

Similarly, the following access expressions would return TRUE if lsap(201) and dmac(701) returned TRUE or if smac(702) returned TRUE:

```
lsap(201) & dmac(701) | smac(702)
```

However, the following access expression would return TRUE only if lsap(201) returned TRUE and either of dmac(701) or smac(702) returned TRUE:

```
lsap(201) & (dmac(701) | smac(702))
```

Referring to the earlier example, “An Example Using NetBIOS Access Filters,” we had the phrase:

“Pass the frame if it is NetBIOS, or if it is an SNA frame destined to address 0110.2222.3333.”

This phrase was converted to the simpler form of:

Pass if “NetBIOS or (SNA and destined to 0110.2222.3333).”

So, for the following configuration:

```

! Access list 201 passes NetBIOS frames (command or response)
access-list 201 permit 0xF0F0 0x0001
!
access-list 202 permit 0x0404 0x0001 ! Permits SNA frames (command or response)
access-list 202 permit 0x0004 0x0001 ! Permits SNA Explorers with NULL DSAP
!
! Access list 701 will permit the FEP MAC address
! of 0110.2222.3333
access-list 701 permit 0110.2222.3333

```

The following access expression would result:

```
access-expression in lsap(201) | (lsap(202) & dmac(701))
```

Access Filters Example

Figure 47 shows two routers connecting two Token Rings to an FDDI backbone.

Figure 47 Network Configuration Using NetBIOS Access Filters

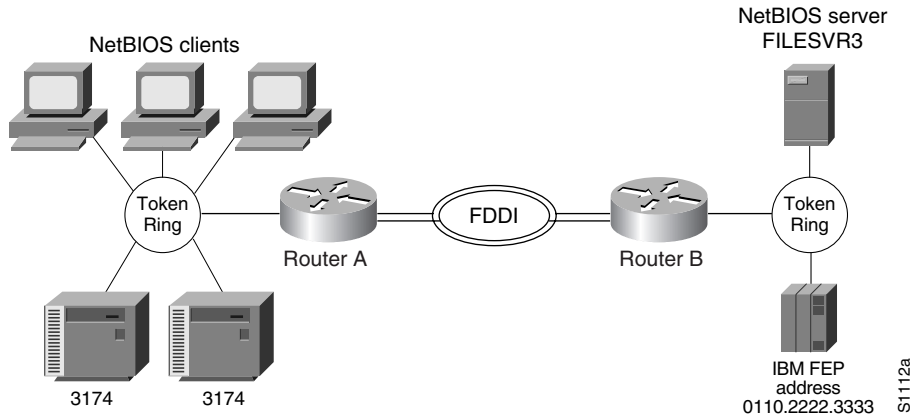

Suppose you want to permit the IBM 3174 cluster controllers to access the FEP at address 0110.2222.3333, and also want the NetBIOS clients to access the NetBIOS server named FILESVR3. The following set of router configuration commands would meet this need:

```
netbios access-list host MIS permit FILESVR3
netbios access-list host MIS deny *
!
access-list 202 permit 0x0404 0x0001 ! Permits SNA frames (command or response)
access-list 202 permit 0x0004 0x0001 ! Permits SNA Explorers with NULL DSAP
!
access-list 701 permit 0110.2222.3333
!
interface tokenring 0
access-expression in (lsap(202) & dmac(701)) | netbios-host(MIS)
```

Fast-Switching Example

The following example disables fast switching between two Token Ring interfaces in the same router. Frames entering Token Ring interfaces 0 or 1 will not be fast switched to the other interface.

```
! global command establishing the ring group for the interface configuration commands
source-bridge ring-group 2
!
! commands that follow apply to interface token 0
interface tokenring 0
! enable srb between local ring 1, bridge 1, and target ring 2
source-bridge 1 1 2
!disable source-route fast-switching cache on interface token 0
no source-bridge route-cache
!
interface token 1
! enable srb between local ring 2, bridge 1, and target ring 1
source-bridge 2 1 1
no source-bridge route-cache
```

Autonomous Switching Example

The following example enables use of autonomous switching between two ciscoBus Token Ring interfaces in the same router. Frames entering Token Ring interfaces 0 or 1 will be autonomously switched to the other interface.

```
! global command to apply interface configuration commands to the ring group
source-bridge ring-group 2
!
! commands that follow apply to interface token 0
interface tokenring 0
! enable srb between local ring 1, bridge 1, and target ring 2
source-bridge 1 1 2
! enable autonomous switching for interface token 0
source-bridge route-cache cbus
!
interface tokenring 1
! enable srb between local ring 2, bridge 1, and target ring 1
source-bridge 2 1 1
source-bridge route-cache cbus
```

Back-to-Back Routers ATM Configuration Example

Figure 48 shows a back-to-back scenario with two ATM adapters that are connected. There is no ATM switch in this example.

Figure 48 Connecting Routers Back-to-Back

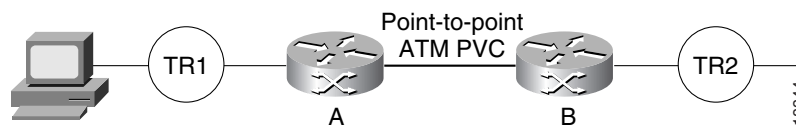

Following are the configurations for routers A and B:

Router A

```
interface atm slot/port
  atm clock
interface atm slot/port.1 point-to-point
  atm pvc 1 10 12 aal5snap
  source-bridge 200 1 100 conserve-ring
  source-bridge spanning
```

Router B

```
interface atm slot/port.1 point-to-point
  atm pvc 2 10 12 aal5snap
  source-bridge 100 1 200 conserve-ring
  source-bridge spanning
```

Single ATM PVC and Single Virtual Ring Per Router Configuration Example

Figure 49 shows an example with frames from Token Ring 1 destined to Token Ring 2 and an ATM switch connecting the routers.

Figure 49 Single ATM PVC and Single Virtual Ring Per Router

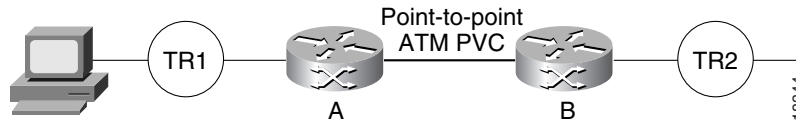

Router A

```
interface atm slot/port
interface atm slot/port.1 point-to-point
  atm pvc 1 10 12 aal5snap
  source-bridge 200 1 100 conserve-ring
  source-bridge spanning
```

Router B

```
interface atm slot/port.1 point-to-point
  atm pvc 2 0 12 aal5snap
  source-bridge 100 1 200 conserve-ring
  source-bridge spanning
```

The following configuration does not use the **conserve-ring** argument in the configuration and the PVC is allocated its own virtual ring number.

Router A

```
source-bridge ring-group 100

interface atm slot/port
interface atm slot/port.1 point-to-point
  atm pvc 1 0 12 aal5snap
  source-bridge 5 1 100
  source-bridge spanning
```

Router B

```
source-bridge ring-group 200

interface atm slot/port
interface atm slot/port.1 point-to-point
  atm pvc 2 0 12 aal5snap
  source-bridge 5 1 200
  source-bridge spanning
```

Multiple ATM PVCs and Multiple Virtual Rings on One Router Configuration Example

Figure 50 shows multiple ATM PVCs and multiple virtual rings on a router.

Figure 50 Multiple ATM PVCs and Multiple Virtual Rings on a Router

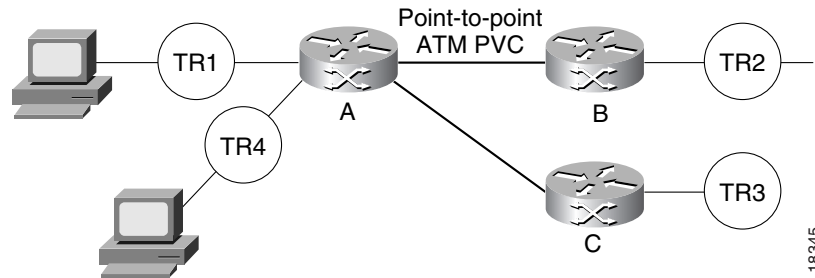

Following are the configurations for routers A, B, and C:

Router A

```
interface atm slot/port.1 point-to-point
 atm pvc 1 10 12 aal5snap
 source-bridge 200 1 100 conserve-ring
 source-bridge spanning
```

```
interface atm slot/port.2 point-to-point
 atm 2 0 12 aal5snap
 source-bridge 300 2 101 conserve-ring
 source-bridge spanning
```

Router B

```
interface atm slot/port.1 point-to-point
 atm pvc 3 0 12 aal5snap
 source-bridge 100 1 200 conserve-ring
 source-bridge spanning
```

Router C

```
interface atm slot/port.1 point-to-point
 atm pvc 4 0 12 aal5snap
 source-bridge 101 2 300 conserve-ring
 source-bridge spanning
```

Multiple ATM PVCs with a Single Virtual Ring on the Router Configuration Example

Figure 51 shows traffic going from Token Ring 1 to Token Ring 2 and Token Ring 3.

Figure 51 Multiple ATM PVCs with a Single Virtual Ring on the Router

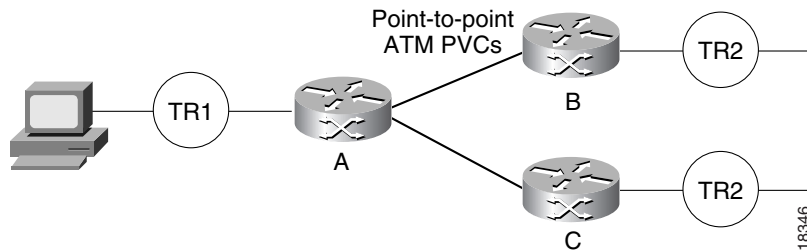

Following are the configurations for routers A, B, and C:

Router A

```
interface atm slot/port.1 point-to-point
 atm pvc 1 0 12 aal5snap
 source-bridge 200 1 100 conserve-ring
 source-bridge spanning
```

```
interface atm slot/port.2 point-to-point
 atm pvc 2 0 2 aal5snap
 source-bridge 300 2 100 conserve-ring
 source-bridge spanning
```

Router B

```
interface atm slot/port.1 point-to-point
 atm pvc 3 0 2 aal5snap
 source-bridge 100 1 200 conserve-ring
 source-bridge spanning
```

Router C

```
interface atm slot/port.1 point-to-point
 atm pvc 4 1 3 aal5snap
 source-bridge 100 2 300 conserve-ring
 source-bridge spanning
```