



Install the Cisco NCS 1014 Chassis



This chapter contains procedures to install the Cisco NCS 1014 chassis.

- [Rack Compatibility, on page 1](#)
- [General Power and Grounding Requirements, on page 3](#)
- [Install the Cisco NCS 1014 Chassis on an EIA/ANSI/ETSI Rack, on page 5](#)

Rack Compatibility

This section provides rack compatibility details for the Cisco NCS 1014.

Figure 1: Four Post Rack Type

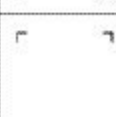
4 – Post Type (Hole EIA Universal)		Compatibility
All 23" Type rack		✓
19" Type rack L-Type Post		✓
19" Type Racks Flat-Post		✓
19" Type racks C- Type Post		✗
ETSI Type rack (Hole ETSI Universal)		✓

3041182

Figure 2: Four Post Rack Type

4 – Post Type (Hole EIA Universal)		Compatibility
19" Type racks	⌈ ⌋	Conditionally Acceptable (X > 18mm)
C- Type Post	⌈ ⌋	

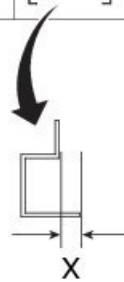

368184

Figure 3: Two Post Rack Type

2 – Post Type (Hole EIA Universal)			Compatibility
19" rack type (Opening 450mm)			✓ Width of the Post 3" or 5"
19" rack type (Opening 450mm)			✗
ETSI Type rack (Hole ETSI Universal)			✓

368966

Figure 4: Rack Specification

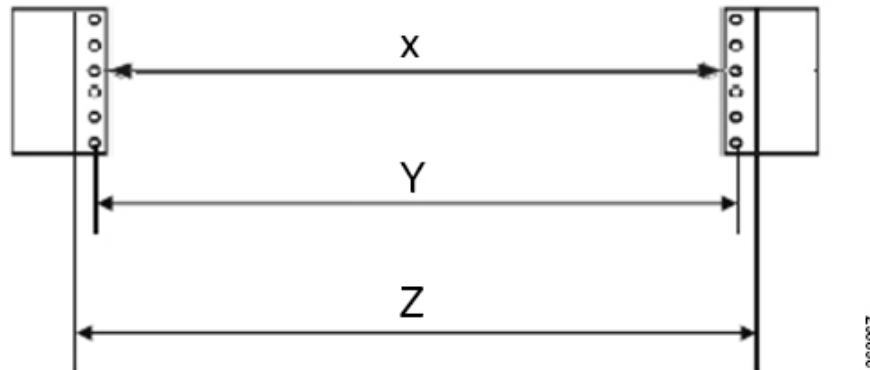

Rack Type	Rack Front Opening X	Rack Mounting Hole Center-Center Y	Mounting Flange Dimension Z
19" racks	450.8mm (17.75")	465mm (18.312")	482.6mm (19")
23" racks	552.45mm (21.75")	566.7mm (22.312")	584.2mm (23")
ETSI racks	500.0mm(19.68")	515.0mm(20.276")	533.4mm(21")



Note The distance between the front and the rear post in a four post rack is 427 mm (closed position) and 707 mm (open position).

General Power and Grounding Requirements

General power and grounding requirements are:

- Installation of the routing system must follow national and local electrical codes:
 - In the United States: United States National Fire Protection Association (NFPA) 70 and United States National Electrical Code (NEC).
 - In Canada: Canadian Electrical Code, part I, CSA C22.1.
 - In other countries: International Electrotechnical Commission (IEC) 60364, parts 1 through 7.
- Two separate and independent AC or DC power sources are needed to provide 2N redundancy for system power. Each power source requires its own circuit breaker.
- Each power source must provide clean power to the site. If necessary, install a power conditioner.
- The site must provide short-circuit (over-current) protection for devices.
- Proper grounding is required at the site to ensure that equipment is not damaged by lightning and power surges.



Note Ground lug connection is mandatory for the AC chassis version too.

- Site power planning must include the power requirements for any external terminals and test equipment you will use with your system.



Note Be sure to review the safety warnings in the Cisco Network Convergence System *Regulatory Compliance and Safety Information for the Cisco Network Convergence System 1014* before attempting to install the chassis.

Ground the Cisco NCS 1014 Chassis

Use this task to ground the Cisco NCS 1014 chassis. In the installation of the chassis, connect the ground lug first.

The NCS 1014 chassis has one grounding point at the front. The following warning label is affixed on the chassis.



Warning High leakage current, earth connection essential before connecting supply.



Caution When terminating the frame ground, do not use soldering lug connectors, screwless (push-in) connectors, quick connect connectors, or other friction-fit connectors.

Before you begin

Install the Air Filter before installing the ground lug onto the Cisco NCS 1014 chassis. See [Install the Air Filter](#).

-
- Step 1** Verify that the office ground cable is connected to the top of the rack and the office ground, according to local site practice.
- Step 2** Remove any paint and other nonconductive coatings from the surfaces between the shelf ground and bay frame ground point. Clean the mating surfaces and apply appropriate antioxidant compound to the bare conductors.
- Step 3** Attach one end of the ground cable (no. 6 AWG cable) dual-hole lug connector.
- Step 4** Align the dual-hole ground lug to the chassis ground point.

Figure 5: NCS 1014 Ground Lug

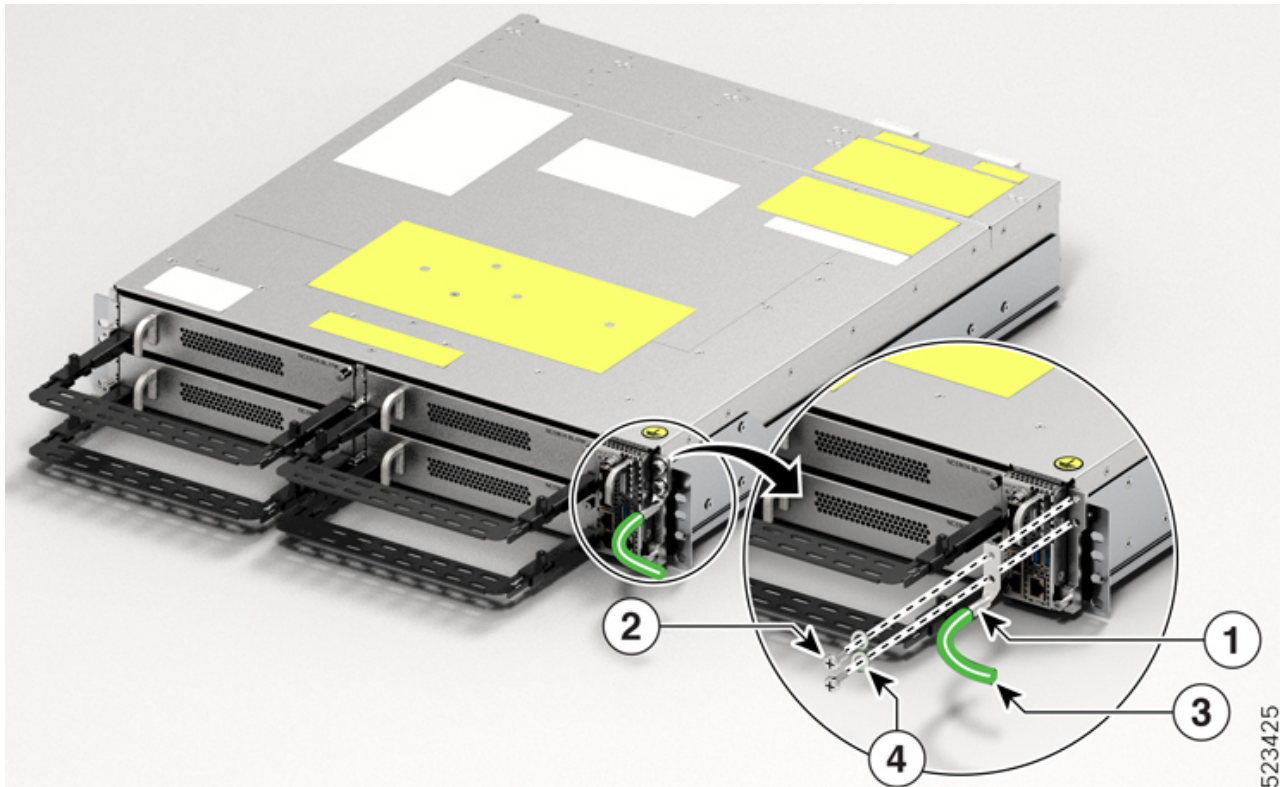

Callout	Accessory
1	Lug
2	M5 pan-head screw (48-1169-01)
3	Ground cable
4	Lock washer (49-100371-01)

The orientation of the lug cable is always at the bottom side.

Step 5 Tighten the M5 pan-head screw (48-1169-01) to a torque value of 3.1 N-m (27.4 lbs-in).

Step 6 Attach the other end of the ground cable to the bay frame using a dual-hole lug connector, according to the equipment rack frame specifications.

Install the Cisco NCS 1014 Chassis on an EIA/ANSI/ETSI Rack

Use this procedure to mount the Cisco NCS 1014 chassis on an EIA/ANSI/ETSI rack.

**Warning** **Rack Mount Instructions**

The following or similar rack-mount instructions are included with the installation instructions:

- **Elevated Operating Ambient**—If installed in a closed or multirack assembly, the operating temperature of the rack environment may be greater than room temperature. Therefore, consideration should be given to installing the equipment in an environment compatible with the maximum ambient temperature (T_{ma}) specified.
- **Reduced Air Flow**—Installation of the equipment in a rack should be such that the amount of air flow required for safe operation of the equipment is not compromised.
- **Mechanical Loading**—Mounting of the equipment in the rack should be such that a hazardous condition is not achieved due to uneven mechanical loading.
- **Circuit Overloading**—Consideration should be given to the connection of the equipment to the supply circuit and the effect that overloading of the circuits might have on overcurrent protection and supply wiring. Appropriate consideration of equipment nameplate ratings should be used when addressing this concern.
- **Reliable Earthing**—Reliable earthing of rack-mounted equipment should be maintained. Particular attention should be given to supply connections other than direct connections to the branch circuit (for example, use of power strips).

It is mandatory to fix the fiber management brackets for all the cards in the chassis before you install the Cisco NCS 1014 chassis onto the rack. See [Attach Fiber Management Bracket](#) section for the detailed procedure.

Figure 6: Line Cards fitted with Fiber Management Bracket

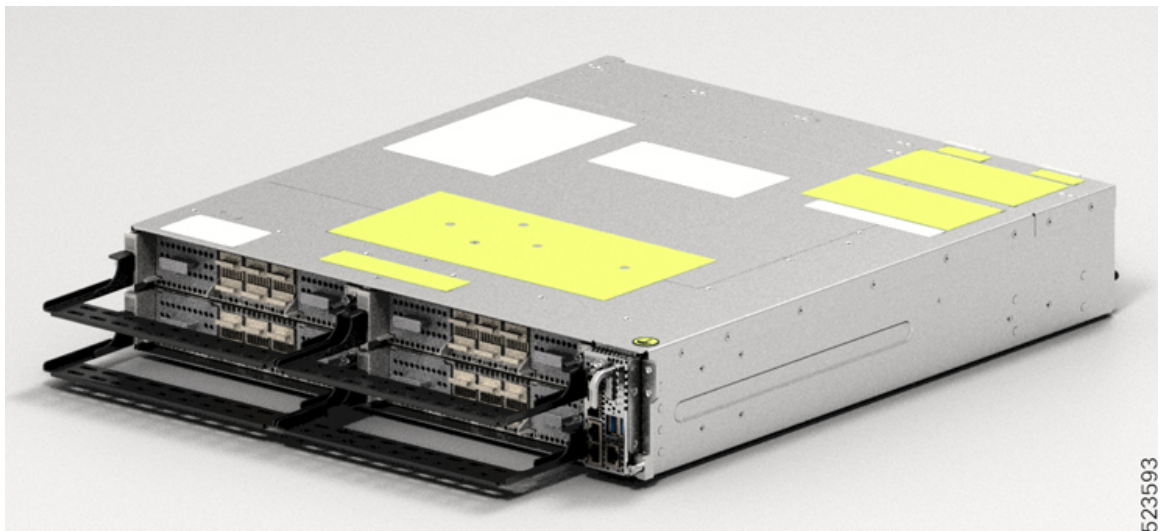

Note In ETSI racks, to maintain a footprint of 600 mm, do not install the cabinet door and maintain the horizontal bar of the fiber management bracket at the shortest length. See [Adjusting the Fiber Management Bracket](#).



Caution Use the sliding rail only for first chassis positioning. You must fix the chassis with screws on the front side.



Caution Use only the fastening hardware provided with Cisco NCS 1014 to prevent loosening, deterioration, and electromechanical corrosion of the hardware and joined material.

Before you begin

Ensure that the rack is compatible. See the [Rack Compatibility, on page 1](#) section.

Step 1

Attach the left and right mounting brackets to the chassis using the screws (48-2029-01) and tighten them to torque value of 1.5 N-m (13.3 lbs-in).

The left and right brackets are marked accordingly.

Figure 7: Fixing the Brackets

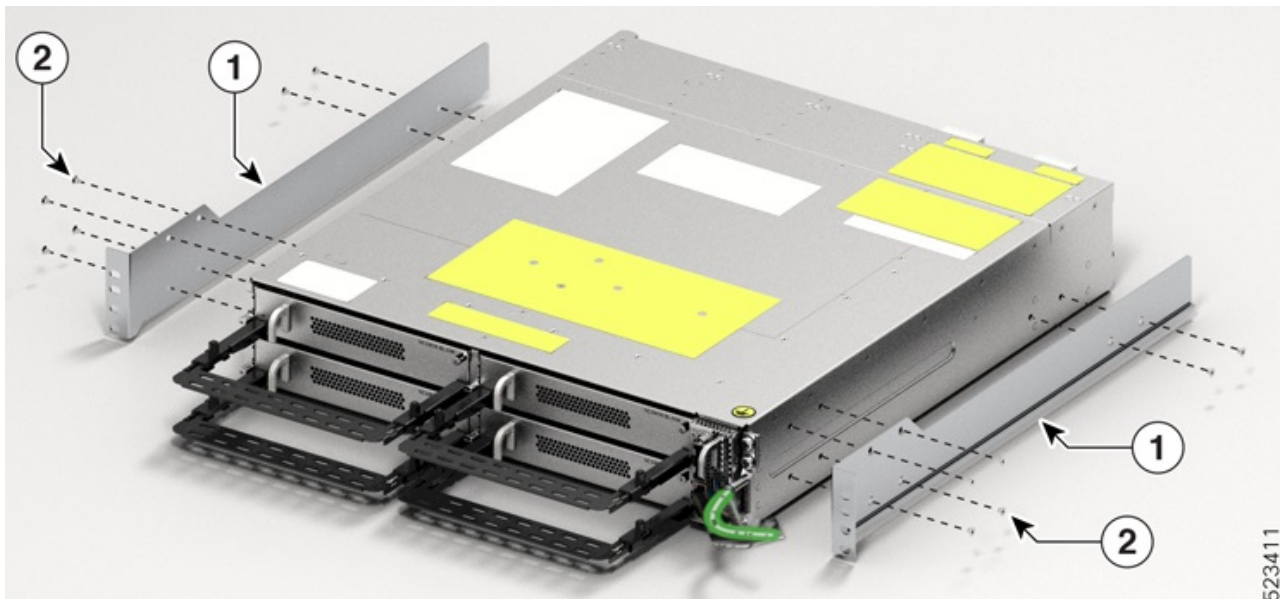

Callout	Component
1	Screws used for brackets
2	Right Bracket (700-116388-01) and Left Bracket (700-116386-01)

Step 2

Install the four post slider or two post slider on the rack.

- [Install the Two Post Slider into an EIA/ANSI Rack](#)
- [Install the Four Post Slider into an EIA/ANSI Rack](#)
- [Install the Two Post Slider into an ETSI Rack](#)
- [Install the Four Post Slider into an ETSI Rack](#)

- Step 3** Insert the chassis (with brackets) onto the sliders assembled on the rack.
- Step 4** After completely inserting the chassis, fasten it with four screws (48-101524-01) on each side of the bracket.
See [Install the Air Filter](#) for the air filter installation procedure, before you fasten the chassis to the rack.
- Step 5** Using a number-2 Phillips screwdriver, tighten the screws to a torque value of 4.65 N-m (41 lbs-in).

Install the Two Post Slider into an EIA/ANSI Rack

Use this procedure to install the two post slider into an EIA/ANSI rack.

- Step 1** Identify the two post slider and adjust the length of the slider (3" to 5").
Slide the inner sliders and adjust the length to mate with the rack surface.

Figure 8: Two Post Slider Identification

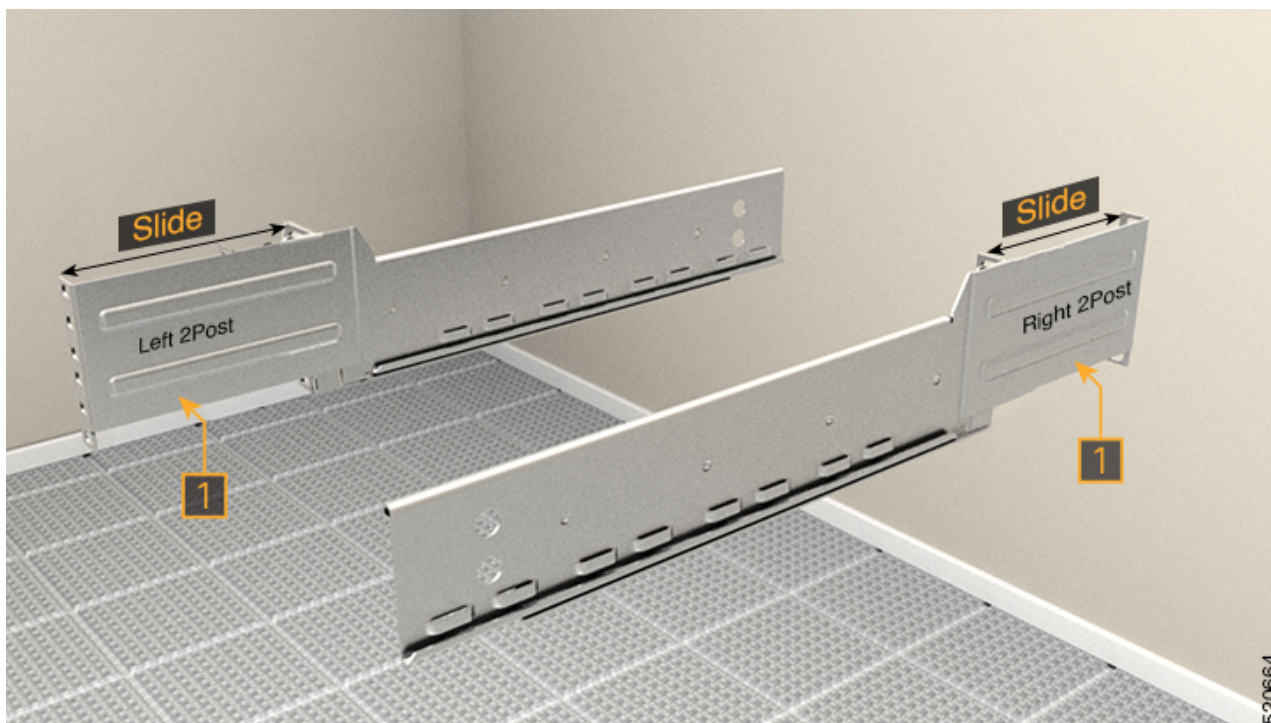

1	Check for marking on the sliders; the markings indicate the right and the left sliders.
---	---

- Step 2** Integrate the two post slider with the rack. Perform one of the following actions:
- For the 19" rack, you can directly fit the slider on to the rack. Perform the following steps:
 - a. On the front side, insert only the top-most screw of the slider (48-101524-01).
 - b. Tighten the screw to torque value of 4.65 N-m (41 lbs-in).

- c. Similarly, on the rear side, insert three screws (48-101524-01) and tighten them to torque value of 4.65 N-m (41 lbs-in).
- For the 23" rack, you can fit the slider on to the rack using an adapter. Perform the following steps: (refer the following image).

The formed surface must always face the inner side of the rack post.

- a. On the front side of the adapter (towards the chassis), insert only the top-most screw of the slider (48-101524-01).
- b. Tighten the screw to torque value of 4.65 N-m (41 lbs-in).
- c. Similarly, on the rear side (towards the chassis), insert three screws (48-101524-01) and tighten them to torque value of 4.65 N-m (41 lbs-in).

For the adapter portion which is towards the rack, you must fit all the six screws on the front and rear side.

Figure 9: Two Post Slider Integration in the 19" Rack

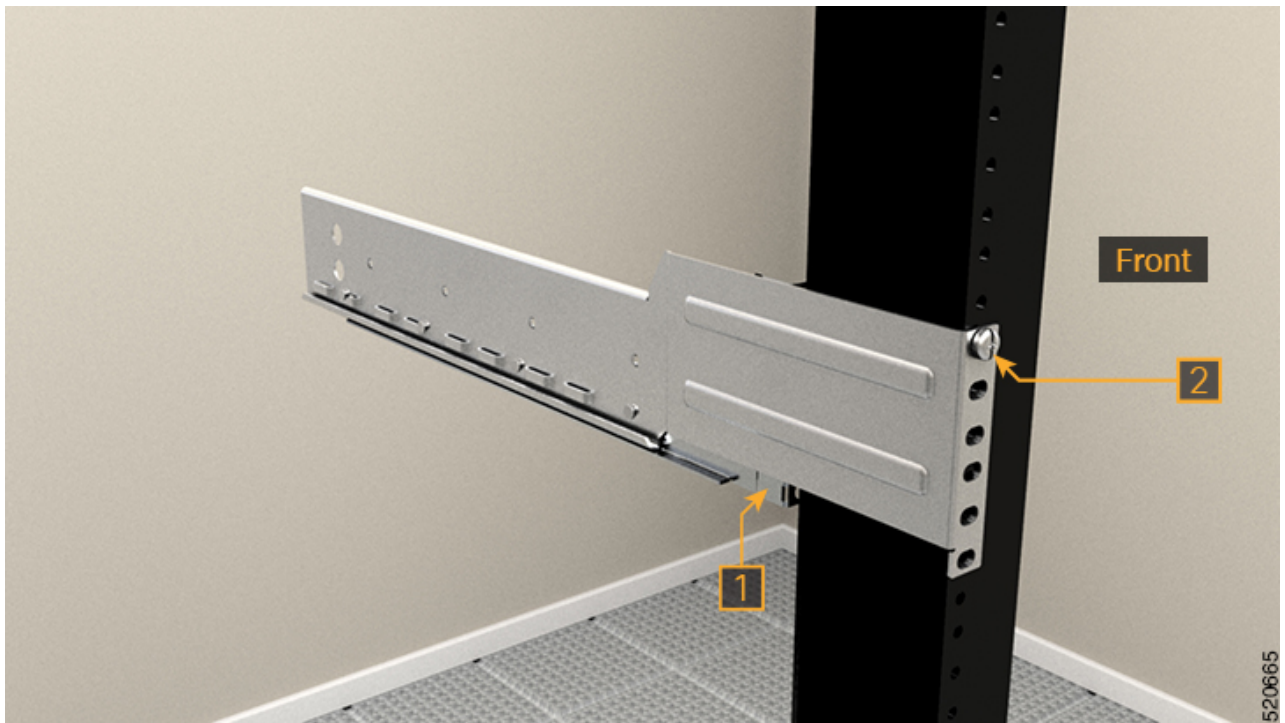

1	Inner surface of the sliding bracket.
2	Slider fixing screws (48-101524-01)

Figure 10: Two Post Slider Integration in the 23" Rack

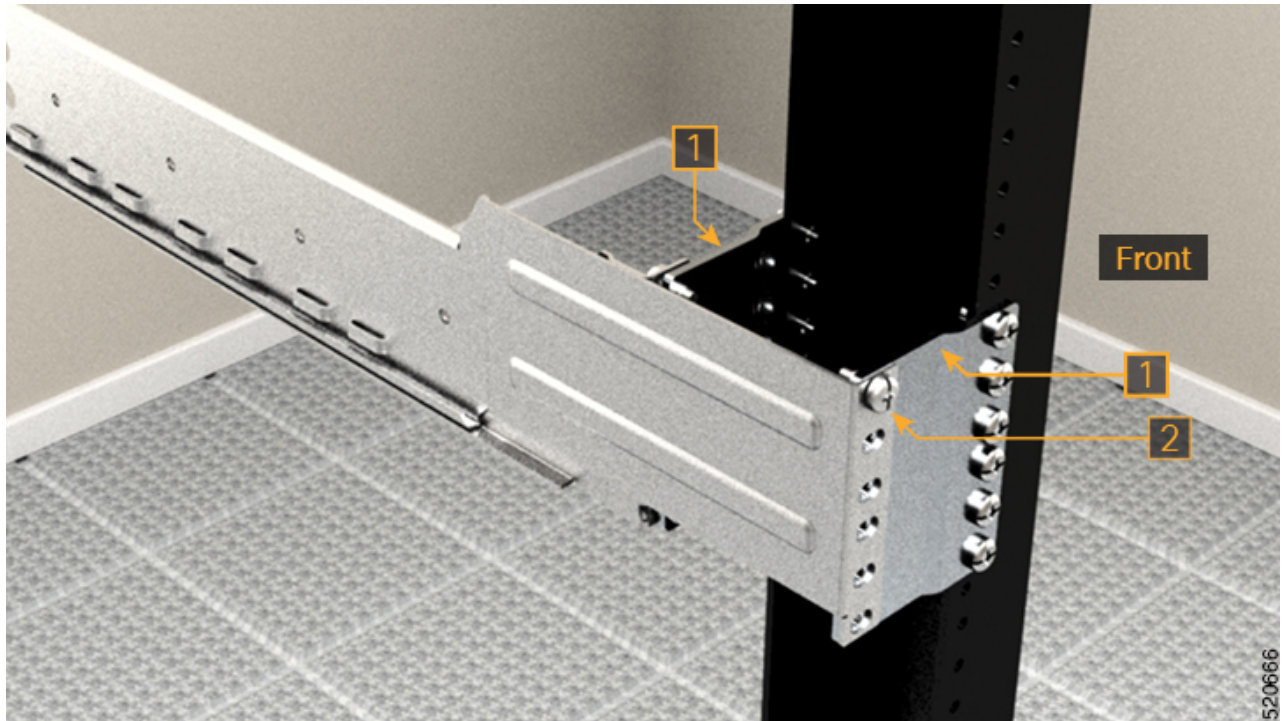

1	Adapter
2	Slider fixing screws (48-101524-01)

Install the Four Post Slider into an EIA/ANSI Rack

Use this procedure to install the four post slider into an EIA/ANSI rack.

- Step 1** Identify the four post slider and adjust the length of the slider.
Slide the inner slider arm and adjust the length to mate with the rack surface.

Figure 11: Four Post Slider Identification

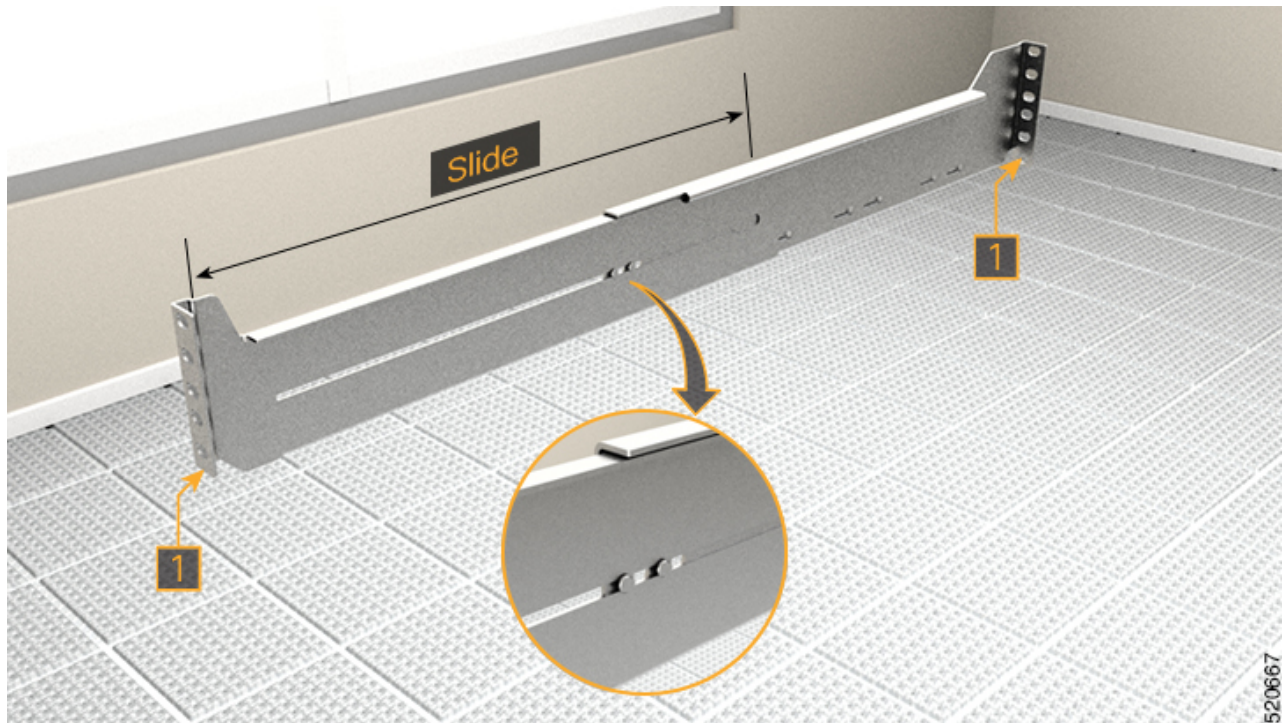

1	Slide and adjust the length of the slider arm.
---	--

Step 2

Integrate the four post slider with the rack. Perform one of the following actions:

- For the 19" rack, you can directly fit the slider on to the rack. Perform the following steps:
 - a. On the front side, insert only the top-most screw of the slider (48-101524-01).
 - b. Tighten the screw to torque value of 4.65 N-m (41 lbs-in).
 - c. Similarly, on the rear side, insert five screws (48-101524-01) and tighten them to torque value of 4.65 N-m (41 lbs-in).
- For the 23" rack, you can fit the slider on to the rack using an adapter. Perform the following steps: (refer the following image).

The formed surface must always face the inner side of the rack post.

- a. On the front side of the adapter (towards the chassis), insert only the top-most screw of the slider (48-101524-01).
- b. Tighten the screw to torque value of 4.65 N-m (41 lbs-in).
- c. Similarly, on the rear side (towards the chassis), insert five screws (48-101524-01) and tighten them to torque value of 4.65 N-m (41 lbs-in).

For the adapter portion which is towards the rack, you must fit all the six screws on the front and rear side.

Figure 12: Four Post Slider Integration in the 19" Rack



Figure 13: Four Post Slider Integration in the 23" Rack

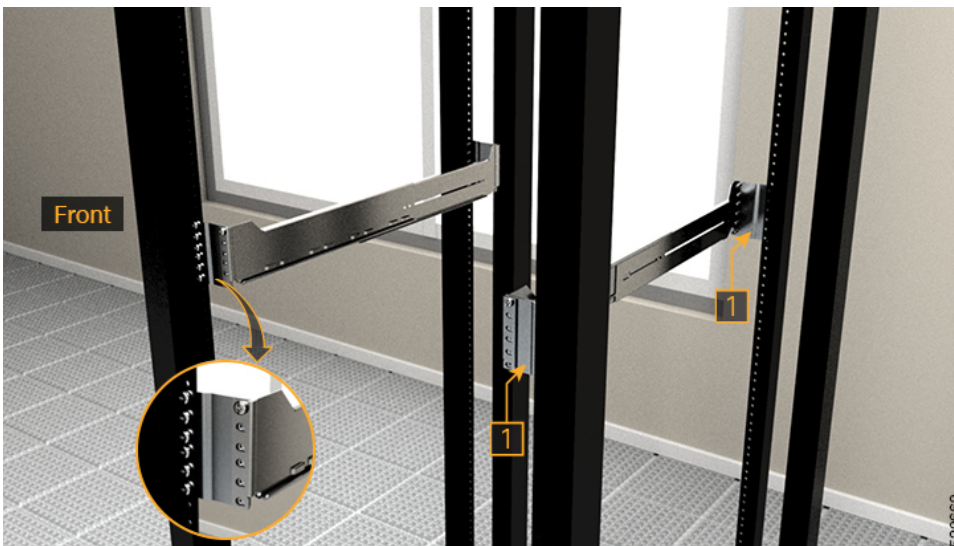

1	Adapter
---	---------

Install the Two Post Slider into an ETSI Rack

Use this procedure to install the two post slider into an ETSI rack.

Step 1

Identify the two post slider and adjust the length of the slider (3" to 5").

Slide the inner sliders and adjust the length to mate with the rack surface.

Figure 14: Two Post Slider Identification

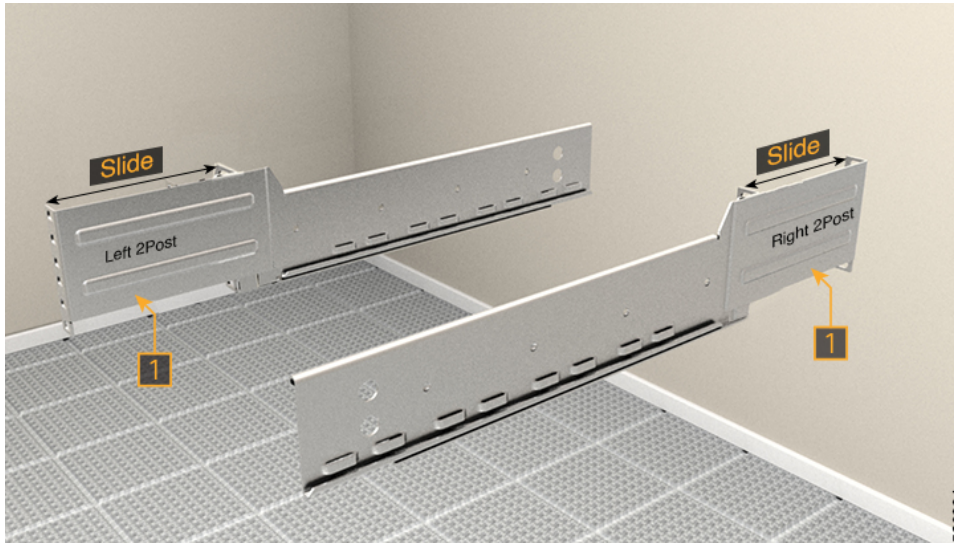

1

Check for marking on the sliders; slide the inner sliders to adjust the length.

Step 2

Integrate the two post slider with the ETSI rack using an adapter.

The formed surface must always face the inner side of the rack post.

- a. On the front side, insert only the top-most screw of the slider (48-101524-01).
- b. Tighten the screw to torque value of 4.65 N-m (41 lbs-in).
- c. Similarly, on the rear side, insert three screws (48-101524-01) and tighten them to torque value of 4.65 N-m (41 lbs-in).

Figure 15: Two Post Slider Integration - ETSI Rack

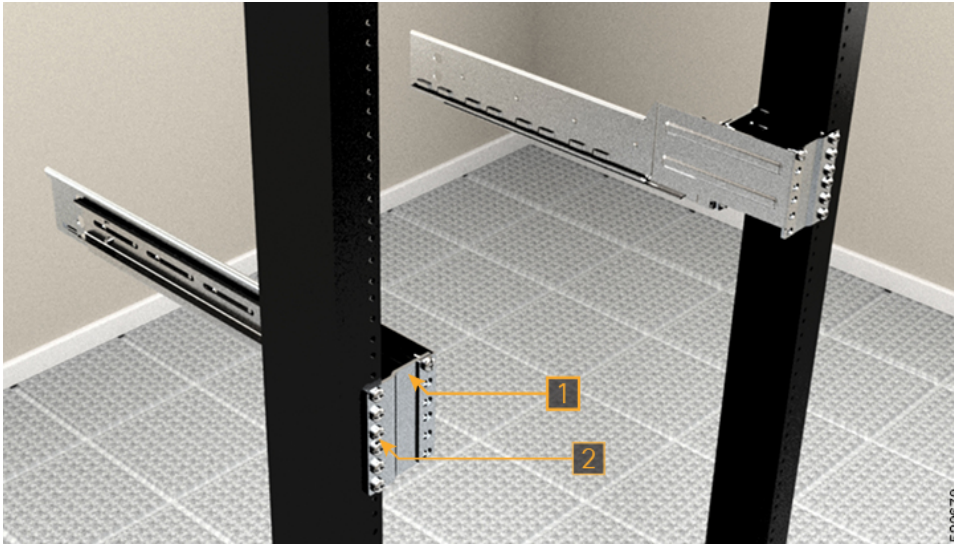

1	Adapter
2	Slider fixing screws (48-101524-01)

Install the Four Post Slider into an ETSI Rack

Use this procedure to install a four post slider into an ETSI rack.

- Step 1** Identify the four post slider and adjust the length of the slider.
Slide the inner slider arm and adjust the length to mate with the rack surface.

Figure 16: Four Post Slider Identification

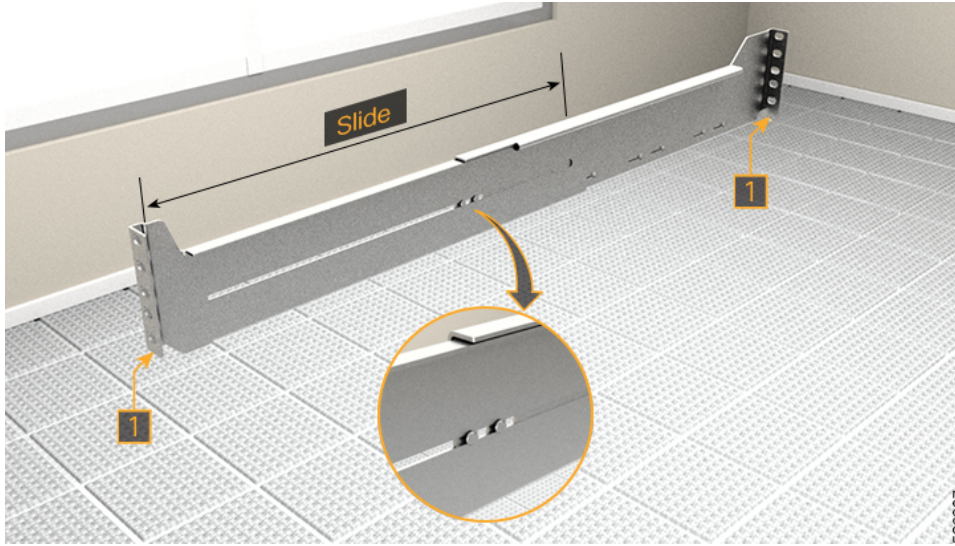

1	Slide and adjust the length of the slider arm.
---	--

Step 2

Integrate the four post slider with the ETSI rack using an adapter.

The formed surface must always face the inner side of the rack post.

- a. On the front side, insert only the top-most screw of the slider (48-101524-01).
- b. Tighten the screw to torque value of 4.65 N-m (41 lbs-in).
- c. Similarly, on the rear side, insert five screws (48-101524-01) and tighten them to torque value of 4.65 N-m (41 lbs-in).

Figure 17: Four Post Slider Integration in the ETSI Rack

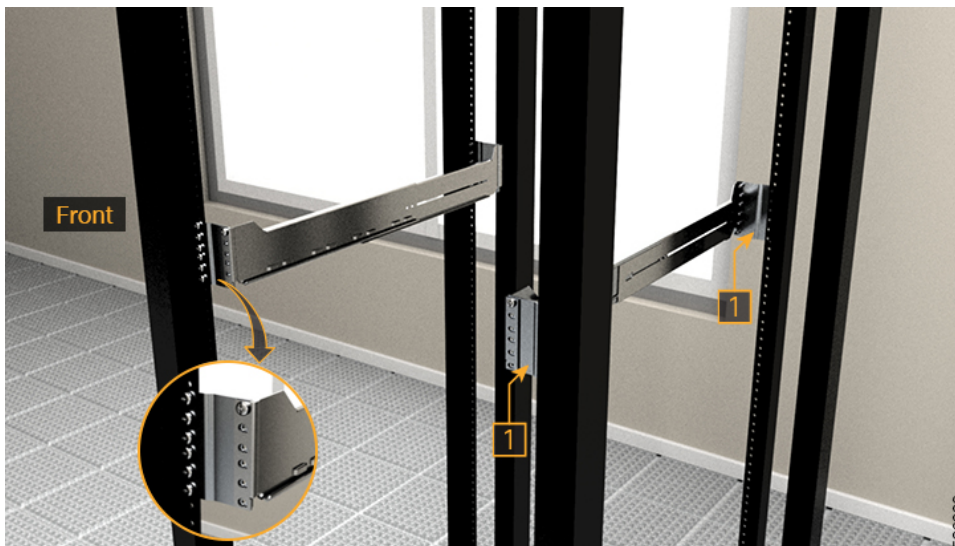

1	Adapter
---	---------
