



## **Configuration Guide for Cisco NCS 1004, IOS XR Release 7.3.x**

**First Published:** 2020-07-16

**Last Modified:** 2024-02-20

### **Americas Headquarters**

Cisco Systems, Inc.  
170 West Tasman Drive  
San Jose, CA 95134-1706  
USA  
<http://www.cisco.com>  
Tel: 408 526-4000  
800 553-NETS (6387)  
Fax: 408 527-0883

THE SPECIFICATIONS AND INFORMATION REGARDING THE PRODUCTS IN THIS MANUAL ARE SUBJECT TO CHANGE WITHOUT NOTICE. ALL STATEMENTS, INFORMATION, AND RECOMMENDATIONS IN THIS MANUAL ARE BELIEVED TO BE ACCURATE BUT ARE PRESENTED WITHOUT WARRANTY OF ANY KIND, EXPRESS OR IMPLIED. USERS MUST TAKE FULL RESPONSIBILITY FOR THEIR APPLICATION OF ANY PRODUCTS.

THE SOFTWARE LICENSE AND LIMITED WARRANTY FOR THE ACCOMPANYING PRODUCT ARE SET FORTH IN THE INFORMATION PACKET THAT SHIPPED WITH THE PRODUCT AND ARE INCORPORATED HEREIN BY THIS REFERENCE. IF YOU ARE UNABLE TO LOCATE THE SOFTWARE LICENSE OR LIMITED WARRANTY, CONTACT YOUR CISCO REPRESENTATIVE FOR A COPY.

The Cisco implementation of TCP header compression is an adaptation of a program developed by the University of California, Berkeley (UCB) as part of UCB's public domain version of the UNIX operating system. All rights reserved. Copyright © 1981, Regents of the University of California.

NOTWITHSTANDING ANY OTHER WARRANTY HEREIN, ALL DOCUMENT FILES AND SOFTWARE OF THESE SUPPLIERS ARE PROVIDED "AS IS" WITH ALL FAULTS. CISCO AND THE ABOVE-NAMED SUPPLIERS DISCLAIM ALL WARRANTIES, EXPRESSED OR IMPLIED, INCLUDING, WITHOUT LIMITATION, THOSE OF MERCHANTABILITY, FITNESS FOR A PARTICULAR PURPOSE AND NON-INFRINGEMENT OR ARISING FROM A COURSE OF DEALING, USAGE, OR TRADE PRACTICE.

IN NO EVENT SHALL CISCO OR ITS SUPPLIERS BE LIABLE FOR ANY INDIRECT, SPECIAL, CONSEQUENTIAL, OR INCIDENTAL DAMAGES, INCLUDING, WITHOUT LIMITATION, LOST PROFITS OR LOSS OR DAMAGE TO DATA ARISING OUT OF THE USE OR INABILITY TO USE THIS MANUAL, EVEN IF CISCO OR ITS SUPPLIERS HAVE BEEN ADVISED OF THE POSSIBILITY OF SUCH DAMAGES.

Any Internet Protocol (IP) addresses and phone numbers used in this document are not intended to be actual addresses and phone numbers. Any examples, command display output, network topology diagrams, and other figures included in the document are shown for illustrative purposes only. Any use of actual IP addresses or phone numbers in illustrative content is unintentional and coincidental.

All printed copies and duplicate soft copies of this document are considered uncontrolled. See the current online version for the latest version.

Cisco has more than 200 offices worldwide. Addresses and phone numbers are listed on the Cisco website at [www.cisco.com/go/offices](http://www.cisco.com/go/offices).

Cisco and the Cisco logo are trademarks or registered trademarks of Cisco and/or its affiliates in the U.S. and other countries. To view a list of Cisco trademarks, go to this URL: <https://www.cisco.com/c/en/us/about/legal/trademarks.html>. Third-party trademarks mentioned are the property of their respective owners. The use of the word partner does not imply a partnership relationship between Cisco and any other company. (1721R)

© 2021 Cisco Systems, Inc. All rights reserved.



## CONTENTS

---

### CHAPTER 1

#### **Cisco NCS 1004 Overview 1**

Cisco NCS 1004 Features 1

Interoperability with Cisco NCS 1001 1

Supported Line Cards 2

1.2T Card Interoperability with OTN-XP Card 4

Prerequisites for Interoperability with OTN-XP Card 4

Scenario on Interoperability with OTN-XP Card 5

Configure Interoperability between 1.2T Card with OTN-XP Card 5

---

### CHAPTER 2

#### **Configuring the Card Mode 7**

1.2T and 1.2TL Line Cards 7

Card Modes 7

Sub 50G Configuration 7

Supported Data Rates 8

Configuring the Card Mode 11

Regeneration Mode 16

Configuring the Card in Regen Mode 16

Verifying the Regen Mode 16

Configuring the BPS 17

Configuring the Trunk Rate for BPSK 18

Viewing the BPSK Trunk Rate Ranges 18

OTN-XP Card 20

LC Mode on OTN-XP Card 20

Configuring the LC Mode 22

Supported Pluggables for OTN-XP Card 27

Muxponder Configuration on OTN-XP Card 27

Configuring the Muxponder Mode for 10G Grey Muxponder	31
Configuring the Muxponder Mode for 4x100G MXP	32
Configuring the Muxponder Mode for 400G TXP	33
Static TPN and TS Allocation for TXP-MXP-Grey Muxponder Modes	34
Configuring the Muxponder Mode for 40x10G Muxponder	36
Configuring the Muxponder Mode for 30x10G	38
Configuring Hybrid Modes Using 40x10G-4x100G-MXP	40
Configuring the Muxponder Mode for 200G on OTN-XP Card	43
Configuring the Muxponder Mode for 300G on OTN-XP Card	47
Configuring the Muxponder Mode for 4x100GE-MXP-DD	51
Configuring Inverse Muxponder on OTN-XP Card for 400GE Client	54
2-QDD-C Line Card	57
Limitations for 2-QDD-C	58
Unsupported Features for 2-QDD-C in R731	58
2-QDD-C Card Modes	58
Supported Data Rates for 2-QDD-C Card	58
Configuring the Card Mode for 2-QDD-C Card	60

**CHAPTER 3****Configuring Controllers 63**

AINS	64
AINS States	64
Soak Time Period	64
Configuring AINS	64
Disabling AINS	65
Displaying the AINS Configuration	66
Configuring AINS on OTN-XP Card	69
FEC	72
FEC States for Ethernet Controller	73
Configuring FEC on the Ethernet Controller	74
FEC States for CoherentDSP Controller	75
Q-Margin Support	76
Configuring FEC on CoherentDSP Controllers	77
Verifying FEC on CoherentDSP Controllers	77
Configuring FEC on OTN-XP Card	78

Verifying FEC on OTN-XP Card	78
Laser Squelching	79
Configuring Laser Squelching on OTN-XP Card	80
Idle Insertion	83
Enabling Idle Insertion on OTN-XP Card	84
LLDP Drop	86
Configuring LLDP Drop	88
Verifying the Status of LLDP Drop	88
Link Layer Discovery Protocol (LLDP) Support on Management Interface	90
DHCP Client	94
DHCP Client Options	94
Enabling DHCP Client on Management Ethernet Interface	95
Verifying DHCP Client on Management Ethernet Interface	96
MAC Address Snooping on Client Ports	97
Configuring MAC Address Snooping on Client Ports	97
Viewing Neighbor MAC Address	98
Transmit Shutdown	99
Configuring Transmit Shutdown on Trunk Optics Controller	99
Verifying Transmit Shutdown on Trunk Optics Controller	99
Loopback	102
Restore Factory Settings	113
Headless Mode	114
Trail Trace Identifier	114
Configure TTI on OTN-XP Card	116
Chromatic Dispersion	120
Transmit Power	122
Laser Bias Current High Threshold	125
Differential Group Delay Threshold	127
Optical Signal to Noise Ratio	129
Chromatic Dispersion Threshold	131
Receive Power Threshold	133
Transmit Power Threshold	135
Frequency	137
Pseudo Random Binary Sequence	137

Configuring Pseudo Random Binary Sequence	139
Verifying PRBS	140
Viewing PRBS Performance Monitoring Parameters	140
Configuring PRBS on OTN-XP Card	141
Verifying PRBS on OTN-XP Card	143
Clearing Bit Errors and Lock Time for PRBS	144
FlexO GID and IID	145
Configuring FlexO GID and IID	145
Verifying FlexO GID and IID	145
Flexo Parameter Update on Inverse Muxponder Configuration on the OTN-XP Card	146

---

**CHAPTER 4**      **Performance Monitoring**    151

Configuring PM Parameters	151
---------------------------	-----

---

**CHAPTER 5**      **IP Access Lists**    165

IP Access List	165
Configuring an IP Access List	166
Verifying ACLs	167

---

**CHAPTER 6**      **Layer 1 Encryption**    169

IKEv2 Overview	170
OTNSec Encryption Overview	172
Prerequisites	173
Limitations	174
Configuration Workflow	174
Configuring an IKEv2 Proposal	176
Configuring an IKEv2 Policy	177
Configuring a Keyring	177
Configuring a IKEv2 Profile	178
Configuring an OTNSec Policy	179
Configuring the GCC Interface	180
Configuring OTNSec on ODU4 Controllers	180
Configuration Example	181
Verification	184

Troubleshooting	185
IKEv2 Certificate-Based Authentication	185
Configuring IKEv2 Certificate-Based Authentication	185
You May Be Interested In	189

**CHAPTER 7****GMPLS UNI for Packet and Optical Integration 191**

Understanding GMPLS UNI	191
Use Case Overview	192
Prerequisites	192
Limitations	193
Configuration Workflow	193
Configure LMP and Alien Wavelength on NCS 2000 Node Using CTC	193
Configure LMP and Alien Wavelength on NCS 2000 Node Using CTC for Signaled Unnumbered Circuit	196
Retrieve Ifindex from NCS 2000 Node	198
Configure LMP on Cisco NCS 1004 Node	198
Configure RSVP on NCS 1004 Node	200
Configure MPLS Tunnel on a NCS 1004 Node for Numbered Circuit	201
Verification	202
General Troubleshooting	209
You May Be Also Interested In	209

**CHAPTER 8****Understanding Remote Node Management Using GCC 211**

Limitations	212
Supported Protocols	213
Enable the GCC Interface	213
Configure the GCC Interface	214
Configure Static Routes Over the GCC Interface	216
Configure OSPF Routes Over the GCC Interface	216
iBGP Support Using GCC	217
Restrictions for iBGP Support Using GCC	217
Enabling the GCC Interface	218
Configuring the Management Interface	218
Configuring the Loopback Interface	218

Configuring the GCC interface	219
Verifying iBGP Support Using GCC	220
Use Case - iBGP Support Using GCC Configuration	221

**CHAPTER 9****Smart Licensing 225**

Understanding Smart Licensing	225
Benefits of Smart Licensing	228
Licensing in NCS 1004	228
Software Entitlements of Cisco NCS 1004	228
Creating a Token	229
Configure Smart Licensing	229
Verifying Smart Licensing Configuration	231
Criteria for the License Consumption of Subsea Networks	235
Criteria for the License Consumption of Long Haul Networks	236
License Registration	237
Smart Licensing for OTN-XP Line Card	237
Checking the License Usage Count	238

**CHAPTER 10****USB Device Automount 241**

USB Automount	241
Mount USB Device	241
Unmount USB Device	242

**CHAPTER 11****Fault Profiles 243**

Fault Profiles	243
Limitations of Fault Profiles	244
Tasks for Configuring Fault Profiles	244
Configure Fault Profiles	244

**CHAPTER 12****OC Support for AAA User 247**

Understanding of AAA	247
Admin Access for NETCONF and gRPC	248
User Profile Mapping from XR VM to System Admin VM	248
How to Allow Read Access to Administration Data for NETCONF and gRPC Clients	249



---

**APPENDIX A**      **SNMP**    251





# CHAPTER 1

## Cisco NCS 1004 Overview

---

This chapter provides an overview of the Cisco Network Convergence Series (NCS) 1004.

- [Cisco NCS 1004 Features, on page 1](#)
- [Interoperability with Cisco NCS 1001, on page 1](#)
- [Supported Line Cards, on page 2](#)
- [1.2T Card Interoperability with OTN-XP Card, on page 4](#)

## Cisco NCS 1004 Features

Cisco NCS 1004 is a two RU unit that supports up to 4.8 Tbps traffic. The NCS 1004 has two redundant, field replaceable AC and DC power supply units and three redundant, field replaceable fans. It also provides a field replaceable controller card. The NCS 1004 has SSD disks both on board the chassis and on the controller card for resiliency. Each NCS 1004 chassis provides four line cardslots. Each NCS 1004 slot can host a line card. See [Supported Line Cards, on page 2](#) for more information.

The NCS 1004 delivers the following benefits:

- Transport of any trunk rate from 150 200 to 600 Gbps wavelengths in 50 Gbps increments on the same platform through software provisioning.
- Support of granular control of baud-rate and modulation format to maximize spectral efficiency.
- One universal transponder that is optimized for performance for metro, long-haul, and submarine applications.
- Support for up to 350,000 ps/nm of residual chromatic dispersion compensation.
- Transport of 100GE and OTU4 client rates on the same platform through software provisioning.
- 600G DWDM, which provides unparalleled scale and density. 64 channels of 600G at 75 GHz providing 38.4 Tbps in 16 RU.
- State-of-the-art AES-256 encryption at scale – 4.8 Tbps of encrypted trunk capacity per 2 RU.

## Interoperability with Cisco NCS 1001

When the Cisco NCS 1001 with Protection Switching Module (PSM) configured as non-revertive, interoperates with Cisco NCS 1004, traffic loss may occur. After the traffic has switched from the working to the protect

path, do not perform a manual switch for 120 seconds. If you perform a manual switch, and the protect path fails, traffic loss of up to 13 seconds can occur.



---

**Note** PSM switching with x50G is not supported as the switching time is more than 50 ms.

---

## Supported Line Cards

The following line cards are supported on Cisco NCS 1004.

### NCS1K4-1.2T-K9 C-Band Line Card

The NCS1K4-1.2T-K9 ( or 1.2 Tbps) C-band line card has 12 QSFP-28 based clients and two DWDM trunk ports. The trunk ports are capable of several line rates with fine control of modulation format, baud-rate, and forward error correction. The trunk ports are software configurable. The line card supports module and slice configurations.



---

**Note** "1.2TC" refers to the NCS1K4-1.2T-K9 C-band line card.

---

The features of the 1.2T line card are:

- The card provides up to 12 100G or OTU4 client ports.
- The baud rate can be controlled between 28 Gbd/s and 72 Gbd/s.
- The frequency range is 191.25 to 196.1 THz with a default value of 193.1 THz.
- The modulation format can be QPSK, 8 QAM, 16 QAM, 32 QAM, or 64 QAM.
- Hybrid modulations formats can be configured through 1/128 bits/symbol granularity.
- Forward Error Correction (FEC) of 27% and 15% overhead across line rates (only 15% for 600G).
- In Release 7.1.1, the trunk line rate can be configured from 150G to 600G in 50G increments.
- In Release 7.2.1 and later releases, the trunk line rate can be configured from 50G to 600G in 50G increments.

### NCS1K4-1.2TL-K9 L-Band Line Card

The NCS1K4-1.2TL-K9 (or 800 Gbps) L-band line card has 12 QSFP-28 based clients and two DWDM trunk ports. The trunk ports are capable of several line rates with fine control of modulation format, baud-rate, and forward error correction and are software configurable. The line card supports module and slice configurations.



---

**Note** "1.2TL" refers to the NCS1K4-1.2TL-K9 L-band line card.

---



---

**Note** There is no support for GMPLS, remote management using GCC, and smart licensing.

---

The features of the 1.2TL line card are:

- The card provides up to eight 100G or OTU4 client ports.
- The client ports map to two trunk ports that operate on any rate between 200G and 400G with 50G increments.
- The modulation format can be controlled between QPSK, 8 QAM, and 16 QAM.
- The baud rate can be controlled between 31.5Gbd/s and 72Gbd/s.
- The frequency range is 186.10 to 190.85 THz with a default value of 188.50 THz. Only 100 MHz spacing is supported.
- Hybrid modulations formats can be configured through 1/128 bits/symbol granularity.
- Forward Error Correction (FEC) supports 15% and 27% overhead.

#### **NCS1K4-OTN-XP Line Card**

From R7.2.1 onwards, NCS 1004 supports the NCS1K4-OTN-XP card with 100G grey-optics support.



---

**Note** "OTN-XP" refers to the NCS1K4-OTN-XP line card.

---

The OTN-XP card contains:

- Eight QSFP 28 ports
- Four QSFP-DD ports
- Two CFP2 ports

The OTN-XP card supports up to 1.6Tbps of OTN aggregation switching functionality to optimize the available bandwidth. A single line card supports 8x100GE muxponder or 2x400 GE transponder applications. The OTN-XP card supports 400GE/OTUC4, 100GE/OTU4, 10GE/OTU2/OTU2e, 16G FC, and 32G FC client rates.

For more information on the mode configuration, see [Muxponder Configuration on OTN-XP Card, on page 27](#).

#### **NCS1K4-2-QDD-C-K9 C-Band Line Card**

From R7.3.1 onwards, NCS 1004 supports the NCS1K4-2-QDD-C-K9 (or 2-QDD-C) C-Band line card. The card has eight client ports (QSFP28 and QSFP-DD) and two DWDM dual sub-channel module trunk ports. The FR4 and AOC are the two optics supported on the 400GE client ports. Each trunk port is capable of 200, 300, and 400 Gbps line rate with fine control of modulation format, baud-rate, and forward error correction. The trunk ports are software configurable. The line card supports module and slice configurations.



---

**Note** "2-QDD-C" refers to the NCS1K4-2-QDD-C-K9 C-band line card.

---

The features of the 2-QDD-C line card are:

- The card provides up to eight 100 GE or two 400 GE client ports.
- The trunk line rate can be configured from 200G to 400G in 100G increments.



---

**Note** The trunk line rates of 250G and 350G are not supported in R7.3.1.

---

- The client to trunk port mapping is based on type of configuration and the line rate.
- The modulation format can be controlled between QPSK, 8 QAM, and 16 QAM including hybrid modulation.
- Hybrid modulations formats can be configured through 1/128 bits/symbol granularity.
- Forward Error Correction (FEC) of Soft Decision FEC 27% and Soft Decision FEC 15%.
- The baud rate can be controlled between 28 Gbd/s and 72 Gbd/s.
- The frequency range is 191.25 to 196.1 THz with a default value of 193.1 THz.

## 1.2T Card Interoperability with OTN-XP Card

The OTN-XP card can be interoperable with the 1.2T card. In an interoperability scenario, the 1.2T card can serve as a trunk port and the OTN-XP card can serve as a client port. The trunk port of OTN-XP can converge 10 x 10 G traffic and transmit as 100G traffic in the OTU4 mode. This OTU4 traffic can further be multiplexed to a higher bandwidth DWDM signal by connecting to 1.2T OTU4 client interface.

### Trunk-side supported pluggables for the OTN-XP card

For interoperability with the 1.2T card, the supported pluggables are inserted in the OTN-XP card.

The OTN-XP card supports the Cisco QSFP-100G-LR4 Pluggable Optics Module (ONS-QSFP28-LR4) on the trunk side. Ensure that you use the same pluggable on the client side of the 1.2T card.

### Client-side supported pluggables for the OTN-XP card

The OTN-XP card supports the following pluggables from its client side connection:

- ONS-QSFP-4x10-MLR
- QSFP-40G-SR4

## Prerequisites for Interoperability with OTN-XP Card

- Configure the OTN-XP card in the 10x10G traffic mode.
- Configure the 1.2T card in the OTU4 client mode with supported trunk rate.

- Ensure that the software installed on both route processors and cards are stable in the supported traffic modes for the 1.2T and OTN-XP card.

## Scenario on Interoperability with OTN-XP Card

Consider a topology, where the OTN-XP card is configured in the 10x10G traffic mode and 1.2T card is configured in the OUT4 client mode with supported trunk rate.

For the solution to work, the OTN-XP trunk optics performs seamless interoperability with 1.2T client optics.

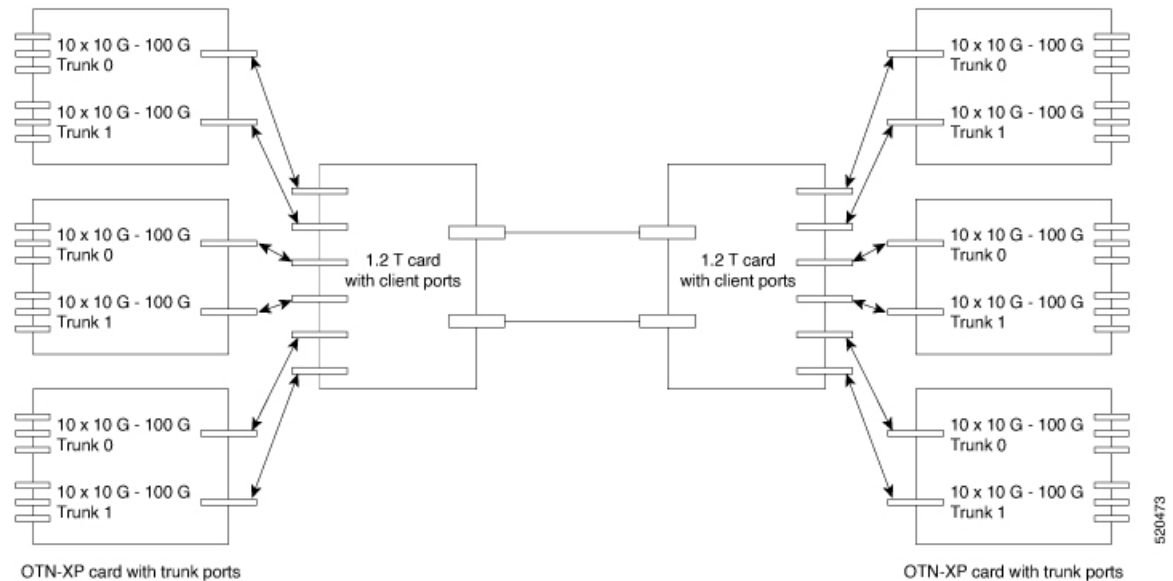

## Configure Interoperability between 1.2T Card with OTN-XP Card

To configure interoperability, perform the following steps:

1. Configure the muxponder mode on the 1.2T card, see [Configuring the Card Mode, on page 11](#).
2. Configure the LC mode on the OTN-XP card, see [Configuring the LC Mode, on page 22](#).
3. Configure the OTN-XP card in the muxponder mode, see [Configuring the Muxponder Mode for 10G Grey Muxponder, on page 31](#).
4. Perform no shut on both trunk ports, use the following commands:

```
controller Optics R/S/I/P
no shut
```

The following is a sample to perform no shut on the trunk port:

```
RP/0/RP0/CPU0:ios#configure
RP/0/RP0/CPU0:ios(config)#controller Optics 0/1/0/0
RP/0/RP0/CPU0:ios(config-Optics)#no shut
RP/0/RP0/CPU0:ios(config-Optics)#description trunk port
RP/0/RP0/CPU0:ios(config-Optics)#exit
RP/0/RP0/CPU0:ios(config)#exit
```



---

**Note** Ensure that there are no alarms generated and link recovery after events such as fiber cut, card reload, pluggable Online Insertion and Removal (OIR), and re-provisions.

---

You can perform the following controller specific configurations on the OTN-XP card grey optics and 1.2T OTU4 client optics:

- Loopback
- Trail Trace Identifier (TTI)
- Maintenance
- Performance Monitoring (PM) enable
- Threshold





## CHAPTER 2

# Configuring the Card Mode

This chapter lists the supported configurations and the procedures to configure the card mode on the line cards.



---

**Note** Unless otherwise specified, “line cards” refers to 1.2T and 1.2TL line cards.

---

- [1.2T and 1.2TL Line Cards, on page 7](#)
- [OTN-XP Card, on page 20](#)
- [2-QDD-C Line Card, on page 57](#)

## 1.2T and 1.2TL Line Cards

The following section describes the supported configurations and procedures to configure the card modes on the line cards.

### Card Modes

The line cards support module and slice configurations.

The line cards have two trunk ports (0 and 1) and 12 client ports (2 through 13) each. You can configure the line card in two modes:

- Muxponder—In this mode, both trunk ports are configured with the same trunk rate. The client-to-trunk mapping is in a sequence.
- Muxponder slice—In this mode, each trunk port is configured independent of the other with different trunk rates. The client-to-trunk mapping is fixed. For Trunk 0, the client ports are 2 through 7. For Trunk 1, the client ports are 8 through 13.

### Sub 50G Configuration

You can configure the sub 50G or coupled mode on the line card only in the muxponder mode. The following table displays the port configuration for the supported data rates.

Trunk Data Rate (per trunk)	Total Configured Data rate	Card Support	Trunk Ports	Client Ports for Trunk 0 (100G)	Shared Client Port (50G per trunk)	Client Ports for Trunk 1 (100G)
50G	100G	1.2T, 1.2TL	0, 1	-	2	-
150G	300G	1.2T, 1.2TL	0, 1	2	3	4
250G	500G	1.2T, 1.2TL	0, 1	2, 3	4	5, 6
350G	700G	1.2T, 1.2TL	0, 1	2, 3, 4	5	6, 7, 8
450G	900G	1.2T	0, 1	2, 3, 4, 5	6	7, 8, 9, 10
550G	1.1T	1.2T	0, 1	2, 3, 4, 5, 6	7	8, 9, 10, 11, 12



**Note** In all x50G configurations, client traffic on the middle port is affected with ODUK-BDI and LF alarms after the **power cycle or link flap** on the trunk side. This issue is raised when the two network lanes work in coupled mode and move from low to high power. To solve this issue, create a new frame either at the near-end or far-end by performing **shut** or **no shut** of the trunk ports.

### Coupled Mode Restrictions

The following restrictions apply to the coupled mode configuration:

- Both trunk ports must be configured with the same bits-per-symbol or baud rate and must be sent over same fiber and direction.
- The chromatic dispersion must be configured to the same value for both trunk ports.
- When trunk internal loopback is configured, it must be done for both trunk ports. Configuring internal loopback on only one trunk results in traffic loss.
- Fault on a trunk port of a coupled pair may cause errors on all clients including those running only on the unaffected trunk port.

## Supported Data Rates

The following data rates are supported on the line card.

In R7.0.1, you can configure the client port to OTU4 only in the muxponder mode. In R7.1.1 and later releases, you can configure the client port to OTU4 in both the muxponder and muxponder slice modes. In muxponder slice mode, both the slices must be configured with either OTU4 or 100GE Ethernet client rates in R7.1.1. In R7.2.0, a mixed configuration of OTU4 and 100GE is supported in the muxponder slice mode. LLDP drop, L1 encryption, and AINS are not supported on the OTU4 configuration.

The following table displays the client and trunk ports that are enabled for the muxponder configuration.

Trunk Data Rate	Card Support	Client Data Rate (100GE, OTU4)	Trunk Ports	Client Ports
100	1.2T, 1.2TL	100GE, OTU4	0	2
200	1.2T, 1.2TL	100GE, OTU4	0, 1	2, 3, 4, 5
300	1.2T, 1.2TL	100GE, OTU4	0, 1	2, 3, 4, 5, 6, 7
400	1.2T, 1.2TL	100GE, OTU4	0, 1	2, 3, 4, 5, 6, 7, 8, 9
500	1.2T	100GE, OTU4	0, 1	2, 3, 4, 5, 6, 7, 8, 9, 10, 11
600	1.2T	100GE, OTU4	0, 1	2, 3, 4, 5, 6, 7, 8, 9, 10, 11, 12, 13

The following table displays the client and trunk ports that are enabled for the muxponder slice 0 configuration.

Trunk Data Rate	Card Support	Client Data Rate	Trunk Ports	Client Ports
100	1.2T, 1.2TL	100, OTU4	0	2
200	1.2T, 1.2TL	100, OTU4	0	2, 3
300	1.2T, 1.2TL	100, OTU4	0	2, 3, 4
400	1.2T, 1.2TL	100, OTU4	0	2, 3, 4, 5
500	1.2T	100, OTU4	0	2, 3, 4, 5, 6
600	1.2T	100, OTU4	0	2, 3, 4, 5, 6, 7

The following table displays the client and trunk ports that are enabled for the muxponder slice 1 configuration.

Trunk Data Rate	Card Support	Client Data Rate	Trunk Ports	Client Ports
100	1.2T, 1.2TL	100, OTU4	1	8
200	1.2T, 1.2TL	100, OTU4	1	8, 9
300	1.2T, 1.2TL	100, OTU4	1	8, 9, 10
400	1.2T, 1.2TL	100, OTU4	1	8, 9, 10, 11
500	1.2T	100, OTU4	1	8, 9, 10, 11, 12
600	1.2T	100, OTU4	1	8, 9, 10, 11, 12, 13

All configurations can be accomplished by using appropriate values for client bitrate and trunk bitrate parameters of the **hw-module** command.

The following table displays the trunk parameter ranges for the 1.2T card.

Trunk Payload	FEC	Min BPS	Max BPS	Min GBd	Max GBd
50G	15%	1	1.3125	24.0207911	31.5272884
50G	27%	1	1.4453125	24.0207911	34.7175497
100G	15%	1	2.625	24.0207911	63.0545768
100G	27%	1	2.890625	24.0207911	69.4350994
150G	15%	1.3203125	3.9375	24.0207911	71.6359689
150G	27%	1.453125	4.3359375	24.0207911	71.6749413
200G	15%	1.7578125	5.25	24.0207911	71.7420962
200G	27%	2	4.40625	31.51	69.43
250G	15%	2.1953125	6	26.2727403	71.8059237
250G	27%	2.4140625	6	28.9312914	71.9068991
300G	15%	2.6328125	6	31.5272884	71.8485385
300G	27%	2.8984375	6	34.7175497	71.8681352
350G	15%	3.0703125	6	36.7818364	71.8790086
350G	27%	3.3828125	6	40.503808	71.8404724
400G	15%	3.5078125	6	42.0363845	71.9018782
400G	27%	3.8671875	6	46.2900663	71.8197392
450G	15%	3.9453125	6	47.2909326	71.9196757
450G	27%	4.34375	6	52.0763245	71.9327648
500G	15%	4.3828125	6	52.5454806	71.93392
500G	27%	4.8281250	6	57.8625828	71.9068991
550G	15%	4.8203125	6	57.8000287	71.9455787
550G	27%	5.3125	6	63.6488411	71.88575
600G	15%	5.2578125	-	-	71.9552971

The following table displays the trunk parameter ranges for the 1.2TL card.

Trunk Payload	FEC	Min BPS	Max BPS	Min GBd	Max GBd
100G	15%	1	2.625	24.0207911	63.0545768
100G	27%	1	2.890625	24.0207911	69.4350994
150G	15%	1.3203125	3.9375	24.0207911	71.6359689

Trunk Payload	FEC	Min BPS	Max BPS	Min GBd	Max GBd
150G	27%	1.453125	4.3359375	24.0207911	71.6749413
200G	15%	2	4	31.5272884	63.0545768
200G	27%	2	4.40625	31.51664088	69.43509943
250G	15%	2.1953125	4.5	35.0303204	71.8059237
250G	27%	2.4140625	4.5	38.5750552	71.9068991
300G	15%	2.6328125	4.5	42.0363845	71.8485385
300G	27%	2.8984375	4.5	46.2900662857142	71.86813526
350G	15%	3.0703125	4.5	49.0424486	71.8790086
350G	27%	3.3828125	4.5	54.0050773	71.8404724
400G	15%	3.5078125	4.5	56.0485127	71.9018782
400G	27%	3.8671875	4.5	61.72008838	71.81973921

To configure the BPS, see [Configuring the BPS, on page 17](#).

## Configuring the Card Mode

You can configure the line card in the module (muxponder) or slice configuration (muxponder slice).

To configure the card in the muxponder mode, use the following commands.

**configure**

**hw-module location** *location* **mxponder client-rate** {100GE | OTU4}

**hw-module location** *location* **mxponder trunk-rate** {50G | 100G150G | 200G | 250G | 300G | 350G | 400G | 450G | 500G | 550G | 600G }

**commit**

To configure the card in the muxponder slice mode, use the following commands.

**configure**

**hw-module location** *location* **mxponder-slice** *mxponder-slice-number* **client-rate** { 100GE|OTU4}

**hw-module location** *location* **mxponder-slice trunk-rate** { 100G | 200G | 300G | 400G | 500G | 600G }

**commit**

### Examples

The following is a sample in which the card is configured in the muxponder mode with a 550G trunk payload.

```
RP/0/RP0/CPU0:ios#config
Tue Oct 15 01:24:56.355 UTC
RP/0/RP0/CPU0:ios(config)#hw-module location 0/1 mxponder client-rate 100GE
```

```
RP/0/RP0/CPU0:ios(config)#hw-module location 0/1 mxponder trunk-rate 550G
RP/0/RP0/CPU0:ios(config)#commit
```

The following is a sample in which the card is configured in the muxponder mode with a 500G trunk payload.

```
RP/0/RP0/CPU0:ios#config
Sun Feb 24 14:09:33.989 UTC
RP/0/RP0/CPU0:ios(config)#hw-module location 0/2 mxponder client-rate OTU4
RP/0/RP0/CPU0:ios(config)#hw-module location 0/2 mxponder trunk-rate 500G
RP/0/RP0/CPU0:ios(config)#commit
```

The following is a sample in which the card is configured in the muxponder slice 0 mode with a 500G trunk payload.

```
RP/0/RP0/CPU0:ios#config
RP/0/RP0/CPU0:ios(config)#hw-module location 0/1 mxponder-slice 0 client-rate 100GE
RP/0/RP0/CPU0:ios(config)#hw-module location 0/1 mxponder-slice 0 trunk-rate 500G
RP/0/RP0/CPU0:ios(config)#commit
```

The following is a sample in which the card is configured in the muxponder slice 1 mode with a 400G trunk payload.

```
RP/0/RP0/CPU0:ios#config
RP/0/RP0/CPU0:ios(config)#hw-module location 0/1 mxponder-slice 1 client-rate 100GE
RP/0/RP0/CPU0:ios(config)#hw-module location 0/1 mxponder-slice 1 trunk-rate 400G
RP/0/RP0/CPU0:ios(config)#commit
```

The following is a sample in which the card is configured with mixed client rates in the muxponder slice mode.

```
RP/0/RP0/CPU0:ios#configure
Mon Mar 23 06:10:22.227 UTC
RP/0/RP0/CPU0:ios(config)#hw-module location 0/1 mxponder-slice 0 client-rate OTU4 trunk-rate
 500G
RP/0/RP0/CPU0:ios(config)#hw-module location 0/1 mxponder-slice 1 client-rate 100GE trunk-rate
 500G
RP/0/RP0/CPU0:ios(config)#commit
```

### Verifying the Card Configuration

```
RP/0/RP0/CPU0:ios#show hw-module location 0/2 mxponder
Fri Mar 15 11:48:48.344 IST
```

```
Location:                0/2
Client Bitrate:          100GE
Trunk Bitrate:           500G
Status:                  Provisioned
LLDP Drop Enabled:      FALSE
Client Port              Mapper/Trunk Port  CoherentDSP0/2/0/0  CoherentDSP0/2/0/1
Traffic Split Percentage
```

HundredGigECtrlr0/2/0/2	ODU40/2/0/0/1	100	0
HundredGigECtrlr0/2/0/3	ODU40/2/0/0/2	100	0
HundredGigECtrlr0/2/0/4	ODU40/2/0/0/3	100	0
HundredGigECtrlr0/2/0/5	ODU40/2/0/0/4	100	0
HundredGigECtrlr0/2/0/6	ODU40/2/0/0/5	100	0
HundredGigECtrlr0/2/0/7	ODU40/2/0/1/1	0	100
HundredGigECtrlr0/2/0/8	ODU40/2/0/1/2	0	100
HundredGigECtrlr0/2/0/9	ODU40/2/0/1/3	0	100
HundredGigECtrlr0/2/0/10	ODU40/2/0/1/4	0	100
HundredGigECtrlr0/2/0/11	ODU40/2/0/1/5	0	100

The following is a sample output of the coupled mode configuration where the shared client port is highlighted.

```
RP/0/RP0/CPU0:ios#show hw-module location 0/1 mxponder
Tue Oct 15 01:25:57.358 UTC

Location:                0/1
Client Bitrate:          100GE
Trunk Bitrate:           550G
Status:                  Provisioned
LLDP Drop Enabled:      FALSE
Client Port              Mapper/Trunk Port      CoherentDSP0/1/0/0 CoherentDSP0/1/0/1
                        Traffic Split Percentage

HundredGigEctr0/1/0/2   ODU40/1/0/0/1           100                0
HundredGigEctr0/1/0/3   ODU40/1/0/0/2           100                0
HundredGigEctr0/1/0/4   ODU40/1/0/0/3           100                0
HundredGigEctr0/1/0/5   ODU40/1/0/0/4           100                0
HundredGigEctr0/1/0/6   ODU40/1/0/0/5           100                0
HundredGigEctr0/1/0/7   ODU40/1/0/0/6           50                 50
HundredGigEctr0/1/0/8   ODU40/1/0/1/1           0                  100
HundredGigEctr0/1/0/9   ODU40/1/0/1/2           0                  100
HundredGigEctr0/1/0/10  ODU40/1/0/1/3           0                  100
HundredGigEctr0/1/0/11  ODU40/1/0/1/4           0                  100
HundredGigEctr0/1/0/12  ODU40/1/0/1/5           0                  100
```

The following is a sample output of all the muxponder slice 0 configurations.

```
RP/0/RP0/CPU0:ios#show hw-module location 0/1 mxponder-slice 0
Fri Mar 15 06:04:18.348 UTC

Location:                0/1
Slice ID:                0
Client Bitrate:          100GE
Trunk Bitrate:           500G
Status:                  Provisioned
LLDP Drop Enabled:      FALSE
Client Port              Mapper/Trunk Port      CoherentDSP0/1/0/0
                        Traffic Split Percentage

HundredGigEctr0/1/0/2   ODU40/1/0/0/1           100
HundredGigEctr0/1/0/3   ODU40/1/0/0/2           100
HundredGigEctr0/1/0/4   ODU40/1/0/0/3           100
HundredGigEctr0/1/0/5   ODU40/1/0/0/4           100
HundredGigEctr0/1/0/6   ODU40/1/0/0/5           100
```

The following is a sample output of all the muxponder slice 1 configurations.

```
RP/0/RP0/CPU0:ios#show hw-module location 0/1 mxponder-slice 1
Fri Mar 15 06:11:50.020 UTC

Location:                0/1
Slice ID:                1
Client Bitrate:          100GE
Trunk Bitrate:           400G
Status:                  Provisioned
LLDP Drop Enabled:      TRUE
Client Port              Mapper/Trunk Port      CoherentDSP0/1/0/1
                        Traffic Split Percentage

HundredGigEctr0/1/0/8   ODU40/1/0/1/1           100
HundredGigEctr0/1/0/9   ODU40/1/0/1/2           100
HundredGigEctr0/1/0/10  ODU40/1/0/1/3           100
HundredGigEctr0/1/0/11  ODU40/1/0/1/4           100
```

The following is a sample output of the muxponder slice 1 configuration with client configured as OTU4.

```
RP/0/RP0/CPU0:ios#sh hw-module location 0/0 mxponder-slice 1
Wed Mar 11 13:59:11.073 UTC

Location:          0/0
Slice ID:          1
Client Bitrate:    OTU4
Trunk Bitrate:     200G
Status:            Provisioned
Client Port                Peer/Trunk Port                CoherentDSP0/0/0/1
                        Traffic Split Percentage
OTU40/0/0/8              ODU40/0/0/1/1                100
OTU40/0/0/9              ODU40/0/0/1/2                100
```

The following is a sample to verify the mixed client rate configuration in the muxponder slice mode.

```
RP/0/RP0/CPU0:ios#show hw-module location 0/1 mxponder
Mon Mar 23 06:20:22.227 UTC

Location:          0/1
Slice ID:          0
Client Bitrate:    OTU4
Trunk Bitrate:     500G
Status:            Provisioned
Client Port                Peer/Trunk Port                CoherentDSP0/1/0/0
                        Traffic Split Percentage
OTU40/1/0/2              ODU40/1/0/0/1                100
OTU40/1/0/3              ODU40/1/0/0/2                100
OTU40/1/0/4              ODU40/1/0/0/3                100
OTU40/1/0/5              ODU40/1/0/0/4                100
OTU40/1/0/6              ODU40/1/0/0/5                100

Location:          0/1
Slice ID:          1
Client Bitrate:    100GE
Trunk Bitrate:     500G
Status:            Provisioned
LLDP Drop Enabled: FALSE
ARP Snoop Enabled: FALSE
Client Port                Mapper/Trunk Port                CoherentDSP0/1/0/1
                        Traffic Split Percentage
HundredGigEctrlr0/1/0/8  ODU40/1/0/1/1                100
HundredGigEctrlr0/1/0/9  ODU40/1/0/1/2                100
HundredGigEctrlr0/1/0/10 ODU40/1/0/1/3                100
HundredGigEctrlr0/1/0/11 ODU40/1/0/1/4                100
HundredGigEctrlr0/1/0/12 ODU40/1/0/1/5                100
```

Use the following command to clear alarm statistics on the optics or coherent DSP controller.

**clear counters controller *controllertype* R/S/I/P**

The following is a sample in which the alarm statistics are cleared on the coherent DSP controller.

```
RP/0/RP0/CPU0:ios#show controller coherentDSP 0/1/0/0
Tue Jun 11 05:15:12.540 UTC

Port                : CoherentDSP 0/1/0/0
Controller State    : Up
Inherited Secondary State : Normal
```



```

Configured Secondary State      : Normal
Derived State                   : In Service
Loopback mode                   : None
BER Thresholds                  : SF = 1.0E-5  SD = 1.0E-7
Performance Monitoring          : Enable

Alarm Information:
LOS = 1 LOF = 1 LOM = 0
OOF = 1 OOM = 1 AIS = 0
IAE = 0 BIAE = 0              SF_BER = 0
SD_BER = 2      BDI = 2 TIM = 0
FECMISMATCH = 0 FEC-UNC = 0
Detected Alarms                 : None

Bit Error Rate Information
PREFEC BER                      : 8.8E-03
POSTFEC BER                     : 0.0E+00

TTI :
    Remote hostname              : P2B8
    Remote interface             : CoherentDSP 0/1/0/0
    Remote IP addr               : 0.0.0.0

FEC mode                         : Soft-Decision 15

AINS Soak                       : None
AINS Timer                      : 0h, 0m
AINS remaining time             : 0 seconds
RP/0/RP0/CPU0:ios#clear counters controller coherentDSP 0/1/0/0
Tue Jun 11 05:17:07.271 UTC
All counters are cleared
RP/0/RP0/CPU0:ios#show controllers coherentDSP 0/1/0/1
Tue Jun 11 05:20:55.199 UTC

Port                             : CoherentDSP 0/1/0/1
Controller State                 : Up
Inherited Secondary State       : Normal
Configured Secondary State      : Normal
Derived State                   : In Service
Loopback mode                   : None
BER Thresholds                  : SF = 1.0E-5  SD = 1.0E-7
Performance Monitoring          : Enable

Alarm Information:
LOS = 0 LOF = 0 LOM = 0
OOF = 0 OOM = 0 AIS = 0
IAE = 0 BIAE = 0              SF_BER = 0
SD_BER = 0      BDI = 0 TIM = 0
FECMISMATCH = 0 FEC-UNC = 0
Detected Alarms                 : None

Bit Error Rate Information
PREFEC BER                      : 1.2E-02
POSTFEC BER                     : 0.0E+00

TTI :
    Remote hostname              : P2B8
    Remote interface             : CoherentDSP 0/1/0/1
    Remote IP addr               : 0.0.0.0

FEC mode                         : Soft-Decision 15

AINS Soak                       : None

```

```
AINS Timer : 0h, 0m
AINS remaining time : 0 seconds
```

## Regeneration Mode

In an optical transmission system, 3R regeneration helps extend the reach of the optical communication links by reamplifying, reshaping, and retiming the data pulses. Regeneration helps to correct any distortion of optical signals by converting it to an electrical signal, processing that electrical signal, and then retransmitting it again as an optical signal.

In Regeneration (Regen) mode, the OTN signal is received on a trunk port and the regenerated OTN signal is sent on the other trunk port of the line card and the other way round. In this mode, only the trunk optics controller and coherentDSP controllers are created.

## Configuring the Card in Regen Mode

The supported trunk rates for the different cards are:

- 1.2T card—100G to 600G in multiples of 100G
- 1.2TL card—200G to 400G in multiples of 100G
- 2-QDD-C card—200G to 400G in multiples of 100G

To configure regen mode on 1.2T, 1.2TL, and 2-QDD-C cards, use the following commands:

**configure**

**hw-module location** *location*

**regen**

**trunk-rate** *trunk-rate*

**commit**

**exit**

### Example

The following is a sample to configure the regen mode on 1.2T, 1.2TL, and 2-QDD-C line cards with the trunk-rate 300.

```
RP/0/RP0/CPU0:ios#configure
RP/0/RP0/CPU0:ios(config)#hw-module location 0/0
RP/0/RP0/CPU0:ios(config-hwmod)#regen
RP/0/RP0/CPU0:ios(config-regen)#trunk-rate 300
RP/0/RP0/CPU0:ios(config-regen)#commit
RP/0/RP0/CPU0:ios(config-regen)#exit
```

## Verifying the Regen Mode

The following is a sample to verify the regen mode.

**show hw-module location** *location* **regen**

```
RP/0/RP0/CPU0:ios#show hw-module location 0/0 regen
Mon Mar 25 09:50:42.936 UTC
```

```

Location:                0/0
Trunk Bitrate:          400G
Status:                 Provisioned
East Port               West Port
CoherentDSP0/0/0/0     CoherentDSP0/0/0/1

```

The terms, East Port and West Port are used to represent OTN signal regeneration at the same layer.

## Configuring the BPS

You can configure the Bits per Symbol (BPS) to 3.4375 to support 300G trunk configurations on 75 GHz networks using the following commands:

**configure**

**controller optics *R/S/I/P* bits-per-symbol 3.4375**

**commit**

The following is a sample in which the BPS is configured to 3.4375.

```

RP/0/RP0/CPU0:ios#configure
Wed Mar 27 14:12:49.932 UTC
RP/0/RP0/CPU0:ios(config)#controller optics 0/3/0/0 bits-per-symbol 3.4375
RP/0/RP0/CPU0:ios(config)#commit

```

### Viewing BPS and Baud Rate Ranges

To view the the BPS for a specific range use the following command:

**show controller optics *R/S/I/P* bps-range *bps-range* | include *data-rate* | include *fec-type***

```

RP/0/RP0/CPU0:ios#show controllers optics 0/3/0/0 bps-range 3 3.05 | include 300G | include
SD27
Thu Mar 28 03:01:39.751 UTC
300G          SD27          3.0000000      69.4350994
300G          SD27          3.0078125      69.2547485
300G          SD27          3.0156250      69.0753320
300G          SD27          3.0234375      68.8968428
300G          SD27          3.0312500      68.7192736
300G          SD27          3.0390625      68.5426174
300G          SD27          3.0468750      68.3668671

```

To view the baud for a specific range use the following command:

**show controller optics *R/S/I/P* baud-rate-range *baud-range* | include *data-rate* | include *fec-type***

```

RP/0/RP0/CPU0:ios#show controllers optics 0/3/0/0 baud-rate-range 43 43.4 | include 300G |
include SD27
Thu Mar 28 03:12:36.521 UTC
300G          SD27          4.8046875      43.3545986
300G          SD27          4.8125000      43.2842178
300G          SD27          4.8203125      43.2140651
300G          SD27          4.8281250      43.1441394
300G          SD27          4.8359375      43.0744397
300G          SD27          4.8437500      43.0049648

```

## Configuring the Trunk Rate for BPSK

From R7.2.1 onwards, you can configure trunk rates of 50G, 100G, and 150G to support Binary Phase-Shift Keying (BPSK) modulation. The BPSK modulation enables information to be carried over radio signals more efficiently.

You can configure trunk rates for BPSK using CLI, NetConf YANG, and OC models.

The following table lists the 50G, 100G, and 150G trunk rates with the supported BPSK modulation:

Trunk Rate	BPSK Modulation
50G	1 to 1.4453125
100G	1 to 2.890625
150G	1.453125 to 4.3359375

To configure the trunk rate for BPSK modulation, enter the following commands:

**configure**

**hw-module location** *location* **mxponder**

**trunk-rate** {50G | 100G | 150G}

**commit**

The following example shows how to configure trunk rate to 50G:

```
RP/0/RP0/CPU0:(config)#hw-module location 0/0 mxponder
RP/0/RP0/CPU0:(config-hwmod-mpx)#trunk-rate 50G
RP/0/RP0/CPU0:(config-hwmod-mpx)#commit
```

## Viewing the BPSK Trunk Rate Ranges

To view the trunk rate configured for the BPSK modulation, use the following **show** commands:

```
RP/0/RP0/CPU0:ios(hwmod-mpx)#show hw-module location 0/0 mxponder
```

```
Tue Feb 25 11:13:41.934 UTC
```

```
Location:                0/0
Client Bitrate:          100GE
Trunk Bitrate:           50G
Status:                  Provisioned
LLDP Drop Enabled:       FALSE
ARP Snoop Enabled:       FALSE
Client Port              Mapper/Trunk Port          CoherentDSP0/0/0/0
CoherentDSP0/0/0/1
                          Traffic Split Percentage
```

```
HundredGigECtrlr0/0/0/2   ODU40/0/0/0          50
50
```

```
RP/0/RP0/CPU0:ios#show controllers optics 0/0/0/0
```

Thu Mar 5 07:12:55.681 UTC

Controller State: Up

Transport Admin State: In Service

Laser State: On

LED State: Green

Optics Status

Optics Type: DWDM optics  
 DWDM carrier Info: C BAND, MSA ITU Channel=61, Frequency=193.10THz,  
 Wavelength=1552.524nm

Alarm Status:

-----

Detected Alarms: None

LOS/LOL/Fault Status:

Alarm Statistics:

-----

HIGH-RX-PWR = 0                      LOW-RX-PWR = 2  
 HIGH-TX-PWR = 0                      LOW-TX-PWR = 0  
 HIGH-LBC = 0                          HIGH-DGD = 0  
 OOR-CD = 0                            OSNR = 0  
 WVl-OOL = 0                          MEA = 0  
 IMPROPER-REM = 0  
 TX-POWER-PROV-MISMATCH = 0  
 Laser Bias Current = 0.0 %  
 Actual TX Power = 1.97 dBm  
 RX Power = 1.58 dBm  
 RX Signal Power = 0.60 dBm  
 Frequency Offset = 386 MHz

Performance Monitoring: Enable

THRESHOLD VALUES

-----

Parameter	High Alarm	Low Alarm	High Warning	Low Warning
Rx Power Threshold(dBm)	4.9	-12.0	0.0	0.0
Tx Power Threshold(dBm)	3.5	-10.1	0.0	0.0
LBC Threshold(mA)	N/A	N/A	0.00	0.00

Configured Tx Power = 2.00 dBm  
 Configured CD High Threshold = 180000 ps/nm  
 Configured CD lower Threshold = -180000 ps/nm  
 Configured OSNR lower Threshold = 0.00 dB  
 Configured DGD Higher Threshold = 180.00 ps  
 Baud Rate = 34.7175521851 GBd  
 Bits per Symbol = 1.0000000000 bits/symbol  
 Modulation Type: BPSK  
 Chromatic Dispersion -9 ps/nm  
 Configured CD-MIN -180000 ps/nm CD-MAX 180000 ps/nm  
 Polarization Mode Dispersion = 0.0 ps  
 Second Order Polarization Mode Dispersion = 125.00 ps^2  
 Optical Signal to Noise Ratio = 34.60 dB  
 SNR = 20.30 dB

```

Polarization Dependent Loss = 0.20 dB
Polarization Change Rate = 0.00 rad/s
Differential Group Delay = 2.00 ps
Filter Roll Off Factor : 0.100
Rx VOA Fixed Ratio : 15.00 dB
Enhanced Colorless Mode : 0
Enhanced SOP Tolerance Mode : 0
NLEQ Compensation Mode : 0
Cross Polarization Gain Mode : 0
Cross Polarization Weight Mode : 0
Carrier Phase Recovery Window : 0
Carrier Phase Recovery Extended Window : 0

```

```

AINS Soak           : None
AINS Timer          : 0h, 0m
AINS remaining time : 0 seconds

```

## OTN-XP Card

The following section describes the supported configurations and procedures to configure the card modes on the line card.

### LC Mode on OTN-XP Card

When you install the OTN-XP card in the Cisco NCS 1004 chassis, it is in the POWERED\_ON state. The **LCMODE is not configured for line card** alarm is present on the card and the LED status is AMBER.

```

sysadmin-vm:0_RP0# show platform
Thu Mar 26 21:38:07.305 UTC+00:00
Location  Card Type                HW State    SW State    Config State
-----
0/0       NCS1K4-LC-FILLER             PRESENT     N/A         NSHUT
0/1       NCS1K4-OTN-XP                POWERED_ON N/A        NSHUT
0/RP0    NCS1K4-CNTRLR-K9             OPERATIONAL OPERATIONAL NSHUT
0/FT0    NCS1K4-FAN                    OPERATIONAL N/A         NSHUT
0/FT1    NCS1K4-FAN                    OPERATIONAL N/A         NSHUT
0/FT2    NCS1K4-FAN                    OPERATIONAL N/A         NSHUT
0/PM0    NCS1K4-AC-PSU                OPERATIONAL N/A         NSHUT
0/SC0    NCS1004                       OPERATIONAL N/A         NSHUT

sysadmin-vm:0_RP0# show alarms brief system active
Thu Mar 26 21:38:34.394 UTC+00:00

-----
Active Alarms
-----
Location      Severity      Group        Set time      Description
-----
0             major         environ      03/26/20 20:23:11  Power Module redundancy
lost.
0             critical      environ      03/26/20 20:23:29  Fan: One or more LCs
missing, running fans at max speed.
0/1          not_alarmed shelf       03/26/20 21:38:26 LCMODE is not configured
for line card
sysadmin-vm:0_RP0#

sysadmin-vm:0_RP0# show led location 0/1
Thu Mar 26 21:39:05.101 UTC+00:00

```

```

=====
Location  LED Name                               Mode           Color
=====
0/1
          0/1-Status LED                       WORKING        AMBER
sysadmin-vm:0_RP0#

```

You must select a datapath mode by configuring the LC mode. OTN-XP does not have a default LC mode. After the LC mode is configured using the CLI, the card transitions to the OPERATIONAL state, the alarm clears, and the LED status turns to GREEN.

The LC modes supported on the OTN-XP card are:

- 10G-GREY-MXP
- 4x100G-MXP-400G-TXP
- 40x10G-4x100G-MXP
- 4x100GE-MXP-DD



---

**Note** 100G-TXP LC mode is not supported.

---

Only one LC mode can be configured on the OTN-XP card at a time. When the LC mode is changed using the CLI, the **LCMODE changed, delete the datapath config and reload line card** alarm is present on the card and the DP FPD is in disabled state. To clear the alarm and enable the DP FPD, delete the existing datapath configuration and reload the line card to apply the new LC mode to make the card operational.

If a LC mode requires a different FPGA configuration, and the package is not available, the **OTN\_XP\_DP\_FPD\_PKG is missing, please install the package to proceed** alarm is present on the card. To clear the alarm, install the OTN\_XP\_DP\_FPD\_PKG file. After the package installation is complete, the required FPGA image is copied from the OTN\_XP\_DP\_FPD\_PKG file to the card, the card is automatically reloaded, and the card becomes operational.



---

**Note** The LC mode configuration is a shared plane configuration. The configuration does not enter the preconfigured state when the line card is not available.

---

## Configuring the LC Mode



### Note

- Ensure the OTN\_XP\_DP\_FPD\_PKG file is installed before configuring the LC mode.
- When you insert an OTN-XP line card having a lower FPD version, you must configure a LC mode which is supported on the software release that the line card is loaded with. You cannot upgrade the FPD of a line card if you configure a LC mode supported only in a higher software release.
- The LC\_CPU\_MOD\_FW version on a new OTN-XP line card is 7.3.1. Support for new LC modes or features from version 7.5.1 or higher, such as OTUCn-REGEN mode in 7.5.2, is not available in this line card software. When you install an OTN-XP card for the first time in an NCS 1004 chassis with the controller card software version of 7.5.1 or higher, you must upgrade LC\_CPU\_MOD\_FW, to ensure the availability and support for the LC modes or features that are supported supported in the XR software version. You must configure an LC mode which is supported in the 7.3.1 XR software, such as 4x100G-MXP-400G-TXP, and bring the card to OPERATIONAL state to upgrade the line card software.

To configure the LC mode on the OTN-XP card, use the following commands:

```
configure
```

```
lc-module location location lcmode mode
```

```
commit
```

### Example

To view the LC modes available on the OTN-XP card, use the following command:

```
RP/0/RP0/CPU0:ios#sh lc-module location 0/0 lcmode all
Wed Sep 29 14:41:51.487 UTC
States: A-Available      R-Running      C-Configured
```

Node	Lcmode_Supported	Owner	Options(State)	HW_Ver
0/0	Yes	None	10G-GREY-MXP (A) 4x100G-MXP-400G-TXP (A)	3.0 2.0

From Release 7.3.2 onwards, you can view the hybrid mode options that are supported on the OTN-XP card.

To view the LC modes supported on the OTN-XP card, use the following command:

```
RP/0/RP0/CPU0:ios#show lc-module location 0/3 lcmode all
Wed Aug 11 17:06:29.538 UTC
States: A-Available      R-Running      C-Configured
```

Node	Lcmode_Supported	Owner	Options(State)	HW_Ver
0/3	Yes	CLI	10G-GREY-MXP (A) 4x100G-MXP-400G-TXP (A) <b>40x10G-4x100G-MXP (A)</b> <b>4x100GE-MXP-DD (R/C)</b>	3.0 2.0 <b>3.0</b> <b>7.0</b>





**Note** The 100G-TXP mode is listed when using the **show lc-module location lcmode all** command, but the configuration on 100G-TXP mode is not supported.

The following is a sample in which the OTN-XP card is configured in the 10G-GREY-MXP mode.

```
RP/0/RP0/CPU0:ios#configure
Thu Mar 26 21:40:51.495 UTC
RP/0/RP0/CPU0:ios(config)#lc-module location 0/1 lcmode 10G-GREY-MXP
RP/0/RP0/CPU0:ios(config)#commit
```

### Verifying the LC Mode Configuration

The following is a sample output of a successful 10G-GREY-MXP LC mode configuration after which the card transitions to the OPERATIONAL state, the alarm clears, and the LED status turns to GREEN.

```
RP/0/RP0/CPU0:ios(config)#do show platform
Thu Mar 26 21:41:17.206 UTC
```

Node	Type	State	Config state
0/0	NCS1K4-LC-FILLER	PRESENT	NSHUT
<b>0/1</b>	<b>NCS1K4-OTN-XP</b>	<b>OPERATIONAL</b>	<b>NSHUT</b>
0/RP0/CPU0	NCS1K4-CNTRLR-K9 (Active)	IOS XR RUN	NSHUT
0/FT0	NCS1K4-FAN	OPERATIONAL	NSHUT
0/FT1	NCS1K4-FAN	OPERATIONAL	NSHUT
0/FT2	NCS1K4-FAN	OPERATIONAL	NSHUT
0/PM0	NCS1K4-AC-PSU	OPERATIONAL	NSHUT
0/SC0	NCS1004	OPERATIONAL	NSHUT

```
RP/0/RP0/CPU0:ios(config)#do show alarms brief system active
Thu Mar 26 21:41:29.641 UTC
```

#### Active Alarms

Location	Severity	Group	Set Time	Description
0	Major	Environ	03/26/2020 20:23:11 UTC	Power Module redundancy lost.
0	Critical	Environ	03/26/2020 20:23:29 UTC	Fan: One or more LCs missing, running fans at max speed.

```
RP/0/RP0/CPU0:ios(config)#end
RP/0/RP0/CPU0:ios#show lc-module location 0/1 lcmode all
Thu Mar 26 21:41:58.780 UTC
States: A-Available R-Running C-Configured
```

Node	Lcmode_Supported	Owner	Options(State)	HW_Ver
0/1	Yes	CLI	<b>10G-GREY-MXP (R/C)</b> 4x100G-MXP-400G-TXP (A)	<b>3.0</b> 2.0

```
RP/0/RP0/CPU0:ios#show lc-module location 0/1 lcmode
Thu Mar 26 21:42:18.997 UTC
```

Node	Lcmode_Supported	Owner	Running	Configured
0/1	Yes	CLI	<b>10G-GREY-MXP</b>	<b>10G-GREY-MXP</b>

```
RP/0/RP0/CPU0:ios#admin
```

```

Thu Mar 26 21:42:38.525 UTC

root connected from 192.0.2.3 using ssh on sysadmin-vm:0_RP0
sysadmin-vm:0_RP0# show led location 0/1
Thu Mar 26 21:42:45.337 UTC+00:00
=====
Location  LED Name                    Mode           Color
=====
0/1
          0/1-Status LED                WORKING       GREEN

```

### Example

The following is a sample in which the LC mode is changed from 10G-GREY-MXP to the 4x100G-MXP-400G-TXP mode. In this sample, the datapath configuration is deleted and the card is reloaded to apply the new LC mode.

```

RP/0/RP0/CPU0:ios#show lc-module location all lcmode
Thu Sep 30 10:19:29.853 UTC

```

Node	Lcmode_Supported	Owner	Running	Configured
0/0	Yes	CLI	10G-GREY-MXP	10G-GREY-MXP
0/1	No	N/A	N/A	N/A
0/2	No	N/A	N/A	N/A
0/3	No	N/A	N/A	N/A

```

RP/0/RP0/CPU0:ios#configure
Thu Sep 30 10:19:32.818 UTC
Current Configuration Session Line      User      Date              Lock
00001000-000051f7-00000000 vty1      root        Wed Sep 29 15:26:00 2021
RP/0/RP0/CPU0:ios(config)#no lc-module location 0/0 lcmode 10g-GREY-MXP
RP/0/RP0/CPU0:ios(config)#commit
Thu Sep 30 10:20:34.086 UTC
RP/0/RP0/CPU0:ios(config)#do show alarms brief system active
Thu Sep 30 10:20:52.950 UTC

```

#### Active Alarms

Location	Severity	Group	Set Time	Description
0/PMO Disabled	Major	Environ	09/29/2021 14:41:59 UTC	Power Module Output
0	Major	Environ	09/29/2021 14:42:15 UTC	Power Module redundancy lost.
0	Critical	Environ	09/29/2021 14:42:25 UTC	Fan: One or more LCs missing, running fans at max speed.
0/0	NotAlarmed	Shelf	09/30/2021 10:20:34 UTC	LCMODE changed, delete the datapath config and reload line card

```
RP/0/RP0/CPU0:ios#configure
Thu Sep 30 10:21:41.281 UTC
Current Configuration Session Line      User      Date              Lock
00001000-000051f7-00000000      vty1     root            Wed Sep 29 15:26:00 2021
RP/0/RP0/CPU0:ios(config)#no hw-module location 0/0
RP/0/RP0/CPU0:ios(config)#commit
Thu Sep 30 10:21:49.982 UTC
RP/0/RP0/CPU0:ios(config)#
```

```
RP/0/RP0/CPU0:ios#show platform
Thu Sep 30 10:22:08.482 UTC
```

Node	Type	State	Config state
0/0	<b>NCS1K4-OTN-XP</b>	<b>OPERATIONAL</b>	<b>NSHUT</b>
0/2	NCS1K4-LC-FILLER	PRESENT	NSHUT
0/3	NCS1K4-LC-FILLER	PRESENT	NSHUT
0/RP0/CPU0	NCS1K4-CNTRLR-K9 (Active)	IOS XR RUN	NSHUT
0/FT0	NCS1K4-FAN	OPERATIONAL	NSHUT
0/FT1	NCS1K4-FAN	OPERATIONAL	NSHUT
0/FT2	NCS1K4-FAN	OPERATIONAL	NSHUT
0/PM0	NCS1K4-AC-PSU	OPERATIONAL	NSHUT
0/SC0	NCS1004	OPERATIONAL	NSHUT

```
RP/0/RP0/CPU0:ios#
RP/0/RP0/CPU0:ios#admin
Thu Sep 30 10:23:55.937 UTC
Last login: Thu Sep 30 04:32:57 2021 from 192.0.2.3
root connected from 192.0.2.3 using ssh on sysadmin-vm:0_RP0
sysadmin-vm:0_RP0# hw-module location 0/0 reload
Thu Sep 30 10:24:17.938 UTC+00:00
Reloading the module will be traffic impacting if not properly drained. Continue to Reload
hardware module ? [no,yes] yes
result Card graceful reload request on 0/0 succeeded.
```

```
sysadmin-vm:0_RP0#show platform
Thu Sep 30 10:25:16.876 UTC+00:00
```

Location	Card Type	HW State	SW State	Config State
0/0	<b>NCS1K4-OTN-XP</b>	<b>POWERED_ON</b>	<b>N/A</b>	<b>NSHUT</b>
0/2	NCS1K4-LC-FILLER	PRESENT	N/A	NSHUT
0/3	NCS1K4-LC-FILLER	PRESENT	N/A	NSHUT
0/RP0	NCS1K4-CNTRLR-K9	OPERATIONAL	OPERATIONAL	NSHUT
0/FT0	NCS1K4-FAN	OPERATIONAL	N/A	NSHUT
0/FT1	NCS1K4-FAN	OPERATIONAL	N/A	NSHUT
0/FT2	NCS1K4-FAN	OPERATIONAL	N/A	NSHUT
0/PM0	NCS1K4-2KW-AC	OPERATIONAL	N/A	NSHUT
0/SC0	NCS1004-K9	OPERATIONAL	N/A	NSHUT

```
sysadmin-vm:0_RP0#exit
RP/0/RP0/CPU0:ios#show lc-module location all lcmode
Thu Sep 30 10:29:08.183 UTC
```

Node	Lcmode_Supported	Owner	Running	Configured
0/0	Yes	None	Not running	Not configured
0/1	No	N/A	N/A	N/A
0/2	No	N/A	N/A	N/A
0/3	No	N/A	N/A	N/A

```
RP/0/RP0/CPU0:ios#show platform
Thu Sep 30 10:29:36.075 UTC
```

Node	Type	State	Config state
------	------	-------	--------------

```

-----
0/0          NCS1K4-OTN-XP          POWERED_ON          NSHUT
0/2          NCS1K4-LC-FILLER        PRESENT             NSHUT
0/3          NCS1K4-LC-FILLER        PRESENT             NSHUT
0/RP0/CPU0  NCS1K4-CNTRLR-K9 (Active)        IOS XR RUN         NSHUT
0/FT0       NCS1K4-FAN                       OPERATIONAL        NSHUT
0/FT1       NCS1K4-FAN                       OPERATIONAL        NSHUT
0/FT2       NCS1K4-FAN                       OPERATIONAL        NSHUT
0/PM0       NCS1K4-AC-PSU                     OPERATIONAL        NSHUT
0/SC0       NCS1004                          OPERATIONAL        NSHUT
RP/0/RP0/CPU0:ios#
RP/0/RP0/CPU0:ios#configure
Thu Sep 30 10:29:57.997 UTC
Current Configuration Session Line      User      Date                               Lock
00001000-000051f7-00000000          vty1     root      Wed Sep 29 15:26:00 2021
RP/0/RP0/CPU0:ios(config)#lc-module location 0/0 lcmode 4x100G-MXP-400G-TXP
RP/0/RP0/CPU0:ios(config)#commit
Thu Sep 30 10:30:11.312 UTC
RP/0/RP0/CPU0:ios(config)#end
RP/0/RP0/CPU0:ios#show lc-module location all lcmode
Thu Sep 30 10:40:56.480 UTC

```

Node	Lcmode_Supported	Owner	Running	Configured
0/0	Yes	CLI	4x100G-MXP-400G-TXP	4x100G-MXP-400G-TXP
0/1	No	N/A	N/A	N/A
0/2	No	N/A	N/A	N/A
0/3	No	N/A	N/A	N/A

```

RP/0/RP0/CPU0:ios# RP/0/RP0/CPU0:ios#show platform
Thu Sep 30 10:41:25.093 UTC

```

Node	Type	State	Config state
------	------	-------	--------------

```

-----
0/0          NCS1K4-OTN-XP          OPERATIONAL        NSHUT
0/2          NCS1K4-LC-FILLER        PRESENT             NSHUT
0/3          NCS1K4-LC-FILLER        PRESENT             NSHUT
0/RP0/CPU0  NCS1K4-CNTRLR-K9 (Active)        IOS XR RUN         NSHUT
0/FT0       NCS1K4-FAN                       OPERATIONAL        NSHUT
0/FT1       NCS1K4-FAN                       OPERATIONAL        NSHUT
0/FT2       NCS1K4-FAN                       OPERATIONAL        NSHUT
0/PM0       NCS1K4-AC-PSU                     OPERATIONAL        NSHUT
0/SC0       NCS1004                          OPERATIONAL        NSHUT
RP/0/RP0/CPU0:ios#

```

### Example: 4x100GE-MXP-DD LC Mode

To view the LC modes available on the OTN-XP card, use the following command: The following is a sample in which the OTN-XP card is configured in the 4x100GE-MXP-DD mode.

```

RP/0/RP0/CPU0:ios#show lc-module location all lcmode all
Thu Sep 30 10:43:47.536 UTC
States: A-Available      R-Running      C-Configured

```

Node	Lcmode_Supported	Owner	Options (State)	HW_Ver
0/0	Yes	CLI	100G-TXP (A)	3.0
			10G-GREY-MXP (A)	3.0
			4x100G-MXP-400G-TXP (A)	2.0
			40x10G-4x100G-MXP (A)	3.0
			<b>4x100GE-MXP-DD (R/C)</b>	<b>7.0</b>
			400GE-TXP-DD (A)	1.0

			FC-MXP (A)	4.0
			OTUCn-REGEN (A)	8.0
0/1	No	N/A	N/A	N/A
0/2	No	N/A	N/A	N/A
0/3	No	N/A	N/A	N/A

## Supported Pluggables for OTN-XP Card

The OTN-XP card supports the following trunk and client pluggables:

### Trunk Pluggables

- ONS-CFP2D-400G-C
- QDD-400G-ZRP-S

### Client Pluggables

- QSFP-100G-LR4
- QSFP-100G-FR-S
- QSFP-100G-SR4-S
- QSFP-100G-CWDM4-S
- QSFP-100G-LR4-S
- QSFP-100G-AOC
- QSFP-100G-PSM4
- QSFP-100G-DR-S
- QSFP-4x10-MLR
- QSFP-40G-SR4=
- ONS-QSFP28-LR4

See [Supported Pluggables](#), for the complete list of pluggables supported by NCS 1004.

## Muxponder Configuration on OTN-XP Card

The OTN-XP card has two trunk ports and 12 client ports. The muxponder configuration supports two slices, 0 and 1. You can configure muxponder-slice 0, muxponder-slice 1, or both. Each muxponder-slice supports 10 client interfaces.

From Release 7.3.1 onwards, the OTN-XP card supports two trunk ports for CFP2 DCO on port 12 and port 13, and 8 client ports. For configuration, see [Configuring the Muxponder Mode for 4x100G MXP](#), on page 32.

From Release 7.3.2 onwards, the OTN-XP card supports two trunk ports for QDD ZRP on port 9 and port 11, and 8 client ports. For configuration, see [Configuring the Muxponder Mode for 4x100GE-MXP-DD](#), on page 52.

Table 1: Feature History

Feature Name	Release Information	Description
400 TXP or MXP modes with CFP2 DCO for OTN-XP Card	Cisco IOS XR Release 7.3.1	<p>On the OTN-XP card, you can configure a single 400GE or 4x100G payload that is received over the client port as a 400G signal over DWDM on the line side.</p> <p>The card improves efficiency, performance, and flexibility for customer networks allowing 400GE or 4x100G client transport over 400G WDM wavelength.</p> <p>Commands modified:</p> <ul style="list-style-type: none"> <li>• <b>controller coherentDSP</b></li> <li>• <b>show controller coherentDSP</b></li> </ul>

Table 2: Hardware Module Configuration with Client to Trunk Mapping

Hardware Module Configuration	Line Card Mode	Client Port Rate	Client to Trunk Mapping	Trunk Rate
10G Grey Muxponder	10G-GREY-MXP	OTU2, OTU2e, or 10 GE	<p>Mxponder-slice 0—Client ports 4, 5, and 2 are mapped to the trunk port 0.</p> <p>Mxponder-slice 1—Client ports 7, 6, and 11 are mapped to the trunk port 1.</p> <p>Each client port consists of four lanes, 1, 2, 3, and 4. The lanes 3 and 4 can only be configured for ports 2 and 11. It is not mandatory to configure all 10 client lanes for a slice.</p>	100G

Hardware Module Configuration	Line Card Mode	Client Port Rate	Client to Trunk Mapping	Trunk Rate
400G-MXP	4x100G-MXP -400G-TXP	100GE, OTU4	<p>Mxponder-slice 0—Client ports 1, 6, 7, and 10 are mapped to the trunk port 12.</p> <p>Mxponder-slice 1—Client ports 0, 4, 5, and 8 are mapped to the trunk port 13.</p>	400G
400G-TXP	4x100G-MXP -400G-TXP	400GE	<p>Mxponder-slice 0—Client port 10 is mapped to the trunk port 12.</p> <p>Mxponder-slice 1—Client port 8 is mapped to the trunk port 13.</p>	400G
40x10G	40x10G-4x100G-MXP	OTU2, OTU2e, or 10 GE	<p>Mxponder-slice 0—10G Client ports 0, 1, 2, 3, 4, 5, 6, 7, 9, and 11 mapped to the trunk port 12.</p> <p>Each client port consists of four lanes, 1, 2, 3, and 4.</p>	400G CFP2
30x10G	40x10G-4x100G-MXP	OTU2, OTU2e, or 10 GE	<p>Mxponder-slice 0—10G Client ports 0, 1, 2, 3, 4, 5, 9, and 11 are mapped to the trunk port 12.</p> <p>The client ports 0, 1, 2, 3, 4, 5, and 9 are configured for all four lanes, 1, 2, 3, and 4.</p> <p>The client port 11 is configured for lanes 1 and 2.</p>	300G CFP2

Hardware Module Configuration	Line Card Mode	Client Port Rate	Client to Trunk Mapping	Trunk Rate
20x10G + 2x100G	40x10G-4x100G-MXP	10 GE, 100 GE, OTU2, OTU2e, or OTU4	<p>Mxponder-slice 0—The following 100G and 10G client ports are mapped to trunk port 12.</p> <ul style="list-style-type: none"> <li>• 100G client port—0 and 1</li> <li>• 10G client port—4, 5, 6, and 7 are configured for all four lanes, 1, 2, 3, and 4.</li> <li>• 10G client port—11 and 2 are configured for lanes 3 and 4.</li> </ul>	300G CFP2
10x10G + 3 x 100G	40x10G-4x100G-MXP	10GE, 100GE, OTU4, OTU2, or OTU2e	<p>Mxponder-slice 0—The following 100G and 10G client ports are mapped to a trunk port 12.</p> <ul style="list-style-type: none"> <li>• 100G client port—0, 1, and 6</li> <li>• 10G client port—4 and 5 are configured for all four lanes, 1, 2, 3, and 4.</li> <li>• 10G client port—2 are configured for lanes 3 and 4.</li> </ul>	400G CFP2
200G Muxponder	200G-FOIC2-oFEC-QPSK-1-S 200G-FOIC2-oFEC-8QAM-1-E	OTU4, 100GE	<p>Mxponder-slice 0—Client ports 7 and 10 mapped to the trunk port 12.</p> <p>Mxponder-slice1—Client ports 5 and 8 mapped to the trunk port 13.</p>	200G CFP2



Hardware Module Configuration	Line Card Mode	Client Port Rate	Client to Trunk Mapping	Trunk Rate
QDD ZRP	4x100GE-MXP-DD	100GE	Mxponder-slice 0—Client ports 1, 6, 7, and 10 are mapped to the trunk port 11.  Mxponder-slice 1—Client ports 0, 4, 5, and 8 are mapped to the trunk port 9.	400G

## Configuring the Muxponder Mode for 10G Grey Muxponder



**Note** The LC mode must be configured to 10G-GREY-MXP on the OTN-XP card before you perform this configuration.

To configure the OTN-XP card in the muxponder mode, use the following commands:

### configure

**hw-module location** *location* **mxponder-slice** *mxponder-slice-number*

**trunk-rate** 100G

**client-port-rate** *client-port-number* **lane** *lane-number* **client-type** { 10GE | OTU2 | OTU2e}

**commit**

### Example

The following is a sample in which the OTN-XP card is configured with mixed client rates in the mxponder-slice 0 mode.

```
RP/0/RP0/CPU0:ios#config
Tue Apr 21 09:21:44.460 UTC
RP/0/RP0/CPU0:ios(config)#hw-module location 0/1 mxponder-slice 0
RP/0/RP0/CPU0:ios(config-hwmod-mxp)#trunk-rate 100G
RP/0/RP0/CPU0:ios(config-hwmod-mxp)#client-port-rate 2 lane 3 client-type OTU2
RP/0/RP0/CPU0:ios(config-hwmod-mxp)#client-port-rate 2 lane 4 client-type OTU2
RP/0/RP0/CPU0:ios(config-hwmod-mxp)#client-port-rate 4 lane 1 client-type 10GE
RP/0/RP0/CPU0:ios(config-hwmod-mxp)#commit
```

### Verifying the Muxponder Configuration

The following is a sample to verify the muxponder configuration in the OTN-XP card.

```
RP/0/RP0/CPU0:ios#show hw-module location 0/1 mxponder
Tue Apr 21 09:26:12.308 UTC

Location:                0/1
Slice ID:                 0
Client Bitrate:          MIXED
Trunk Bitrate:           100G
```

```

Status:                Provisioned
LLDP Drop Enabled:    FALSE
ARP Snoop Enabled:    FALSE
Client Port Mapper/Trunk Port Peer/Trunk Port OTU40/0/0/0
Traffic Split Percentage
OTU20/0/0/2/3        NONE          ODU20/0/0/0/2/3        100
OTU20/0/0/2/4        NONE          ODU20/0/0/0/2/4        100
TenGigEctr1r0/0/0/4/1 ODU2E0/0/0/0/4/1      NONE                    100

```

## Configuring the Muxponder Mode for 4x100G MXP



**Note** The LC mode must be configured to 4x100G-MXP-400G-TXP on the OTN-XP card before you perform this configuration. See [Configuring the LC Mode, on page 22](#).

To configure the OTN-XP card in the 4x100 muxponder mode, use the following commands:

**configure**

**hw-module location** *location* **mxponder-slice** *mxponder-slice-number*

**trunk-rate** 400G

**client-port-rate** *client-port-number* **client-type** {100GE | OTU4}

**commit**

### Example

The following is a sample in which the OTN-XP card is configured with 400G trunk rate on the mxponder-slice 0 mode.

```

RP/0/RP0/CPU0:ios#config
Tue Apr 21 09:21:44.460 UTC
RP/0/RP0/CPU0:ios(config)#hw-module location 0/2 mxponder-slice 0
RP/0/RP0/CPU0:ios(config-hwmod-mxp)#trunk-rate 400G
RP/0/RP0/CPU0:ios(config-hwmod-mxp)#client-port-rate 1 client-type 100GE
RP/0/RP0/CPU0:ios(config-hwmod-mxp)#commit

```

The following is a sample in which the OTN-XP card is configured with 400G trunk rate on the mxponder-slice 1 mode.

```

RP/0/RP0/CPU0:ios#config
Tue Apr 21 09:21:44.460 UTC
RP/0/RP0/CPU0:ios(config)#hw-module location 0/2 mxponder-slice 1
RP/0/RP0/CPU0:ios(config-hwmod-mxp)#trunk-rate 400G
RP/0/RP0/CPU0:ios(config-hwmod-mxp)#client-port-rate 8 client-type OTU4
RP/0/RP0/CPU0:ios(config-hwmod-mxp)#commit

```

### Verifying the Muxponder Configuration

The following is a sample to verify the muxponder configuration in the OTN-XP card.

```

RP/0/RP0/CPU0:ios#show hw-module location 0/1 mxponder
Mon Nov 30 01:32:57.338 UTC

Location: 0/1
Slice ID: 0
Client Bitrate: 100GE

```

```

Trunk Bitrate: 400G
Status: Provisioned
LLDP Drop Enabled: FALSE
ARP Snoop Enabled: FALSE
Client Port Mapper/Trunk Port CoherentDSP0/1/0/12
Traffic Split Percentage

HundredGigECtrlr0/1/0/1 ODU40/1/0/12/1 100

Location: 0/1
Slice ID: 1
Client Bitrate: OTU4
Trunk Bitrate: 400G
Status: Provisioned
Client Port Peer/Trunk Port CoherentDSP0/1/0/13
Traffic Split Percentage

OTU40/1/0/8 ODUC40/1/0/13 100

```

## Configuring the Muxponder Mode for 400G TXP



**Note** The LC mode must be configured to 4x100G-MXP-400G-TXP on the OTN-XP card before you perform this configuration.

To configure the OTN-XP card in the 400G TXP mode, use the following commands:

**configure**

**hw-module location** *location* **mxponder-slice** *mxponder-slice-number*

**trunk-rate 400G**

**client-port-rate** *client-port-number* **client-type 400GE**

**commit**

### Example

The following is a sample in which the OTN-XP card is configured with 400G trunk rate on the mxponder-slice 0 mode.

```

RP/0/RP0/CPU0:ios#config
Tue Apr 21 09:21:44.460 UTC
RP/0/RP0/CPU0:ios(config)#hw-module location 0/2 mxponder-slice 0
RP/0/RP0/CPU0:ios(config-hwmod-mxp)#trunk-rate 400G
RP/0/RP0/CPU0:ios(config-hwmod-mxp)#client-port-rate 10 client-type 400GE
RP/0/RP0/CPU0:ios(config-hwmod-mxp)#commit

```

The following is a sample in which the OTN-XP card is configured with 400G trunk rate on the mxponder-slice 1 mode.

```

RP/0/RP0/CPU0:ios#config
Tue Apr 21 09:21:44.460 UTC
RP/0/RP0/CPU0:ios(config)#hw-module location 0/2 mxponder-slice 1
RP/0/RP0/CPU0:ios(config-hwmod-mxp)#trunk-rate 400G
RP/0/RP0/CPU0:ios(config-hwmod-mxp)#client-port-rate 8 client-type 400GE
RP/0/RP0/CPU0:ios(config-hwmod-mxp)#commit

```

## Verifying the Muxponder Configuration

The following is a sample to verify the muxponder configuration in the OTN-XP card.

```
RP/0/RP0/CPU0:ios#show hw-module location 0/1 mxponder
Mon Nov 30 01:36:14.514 UTC
```

```
Location: 0/1
Slice ID: 0
Client Bitrate: 400GE
Trunk Bitrate: 400G
Status: Provisioned
LLDP Drop Enabled: FALSE
ARP Snoop Enabled: FALSE
Client Port Mapper/Trunk Port CoherentDSP0/1/0/12
Traffic Split Percentage
```

```
FourHundredGigECtrlr0/1/0/10 ODU-FLEX0/1/0/12/10 100
```

```
Location: 0/1
Slice ID: 1
Client Bitrate: 400GE
Trunk Bitrate: 400G
Status: Provisioned
LLDP Drop Enabled: FALSE
ARP Snoop Enabled: FALSE
Client Port Mapper/Trunk Port CoherentDSP0/1/0/13
Traffic Split Percentage
```

```
FourHundredGigECtrlr0/1/0/8 ODU-FLEX0/1/0/13/8 100
```

## Static TPN and TS Allocation for TXP-MXP-Grey Muxponder Modes

The OTN-XP card uses the following mapping of tributary port numbers, tributary slots, and clients for the various TXP and MXP configurations.

**Table 3: TPN-TS Mapping in 400GE TXP Configuration**

Slice	Client Port	Client Rate	Trunk Port	Trunk Rate	TPN	TS
0	10	400GE	12	400G	1	1.1 to 4.20
1	8	400GE	13	400G	1	1.1 to 4.20

**Table 4: TPN-TS Mapping in 4 X 100G MXP Configuration**

Slice	Client Port	Client Rate	Trunk Port	Trunk Rate	TPN	TS
0	10	100GE/OTU4	12	400G	1	1.1 to 1.20
	7	100GE/OTU4			2	2.1 to 2.20
	6	100GE/OTU4			3	3.1 to 3.20
	1	100GE/OTU4			4	4.1 to 4.20

Slice	Client Port	Client Rate	Trunk Port	Trunk Rate	TPN	TS
1	8	100GE/OTU4	13	400G	1	1.1 to 1.20
	5	100GE/OTU4			2	2.1 to 2.20
	4	100GE/OTU4			3	3.1 to 3.20
	0	100GE/OTU4			4	4.1 to 4.20

Table 5: TPN-TS Mapping in 10 X 10G Grey Muxponder Configuration

Slice	Client Port	Client Lane	Client Rate	Trunk Port	Trunk Rate	TPN	TS
0	4	1	10GE/OTU2/OTU2e	0	100G	1	1-8
		2	10GE/OTU2/OTU2e			2	9-16
		3	10GE/OTU2/OTU2e			3	17-24
		4	10GE/OTU2/OTU2e			4	25-32
	5	1	10GE/OTU2/OTU2e			5	33-40
		2	10GE/OTU2/OTU2e			6	41-48
		3	10GE/OTU2/OTU2e			7	49-56
		4	10GE/OTU2/OTU2e			8	57-64
	2	3	10GE/OTU2/OTU2e			9	65-72
		4	10GE/OTU2/OTU2e			10	73-80
1	7	1	10GE/OTU2/OTU2e	1	100G	1	1-8
		2	10GE/OTU2/OTU2e			2	9-16
		3	10GE/OTU2/OTU2e			3	17-24
		4	10GE/OTU2/OTU2e			4	25-32
	6	1	10GE/OTU2/OTU2e			5	33-40
		2	10GE/OTU2/OTU2e			6	41-48
		3	10GE/OTU2/OTU2e			7	49-56
		4	10GE/OTU2/OTU2e			8	57-64
	11	3	10GE/OTU2/OTU2e			9	65-72
		4	10GE/OTU2/OTU2e			10	73-80

## Configuring the Muxponder Mode for 40x10G Muxponder

To configure the OTN-XP card in the 40x10G muxponder mode, use the following commands:

**configure**

**hw-module location** *location* **mxponder-slice** *mxponder-slice-number*

**trunk-rate 400G**

**client-port-rate** *client-port-number* **lane** *lane-number* **client-type** {10GE | OTU2 | OTU2E}

**commit**

### Example

The following is a sample in which the OTN-XP card is configured with 400G trunk rate on the mxponder-slice 0 mode.

```
RP/0/RP0/CPU0:ios#config
Tue Apr 21 09:21:44.460 UTC
RP/0/RP0/CPU0:ios(config)#hw-module location 0/3 mxponder-slice 0
RP/0/RP0/CPU0:ios(config-hwmod-mxp)#trunk-rate 400G
RP/0/RP0/CPU0:ios(config-hwmod-mxp)#client-port-rate 0 lane 1 client-type 10GE
RP/0/RP0/CPU0:ios(config-hwmod-mxp)#client-port-rate 0 lane 2 client-type 10GE
RP/0/RP0/CPU0:ios(config-hwmod-mxp)#client-port-rate 0 lane 3 client-type 10GE
RP/0/RP0/CPU0:ios(config-hwmod-mxp)#client-port-rate 0 lane 4 client-type 10GE
RP/0/RP0/CPU0:ios(config-hwmod-mxp)#client-port-rate 1 lane 1 client-type 10GE
RP/0/RP0/CPU0:ios(config-hwmod-mxp)#client-port-rate 1 lane 2 client-type 10GE
RP/0/RP0/CPU0:ios(config-hwmod-mxp)#client-port-rate 1 lane 3 client-type 10GE
RP/0/RP0/CPU0:ios(config-hwmod-mxp)#client-port-rate 1 lane 4 client-type 10GE
RP/0/RP0/CPU0:ios(config-hwmod-mxp)#client-port-rate 2 lane 1 client-type 10GE
RP/0/RP0/CPU0:ios(config-hwmod-mxp)#client-port-rate 2 lane 2 client-type 10GE
RP/0/RP0/CPU0:ios(config-hwmod-mxp)#client-port-rate 2 lane 3 client-type 10GE
RP/0/RP0/CPU0:ios(config-hwmod-mxp)#client-port-rate 2 lane 4 client-type 10GE
RP/0/RP0/CPU0:ios(config-hwmod-mxp)#client-port-rate 3 lane 1 client-type 10GE
RP/0/RP0/CPU0:ios(config-hwmod-mxp)#client-port-rate 3 lane 2 client-type 10GE
RP/0/RP0/CPU0:ios(config-hwmod-mxp)#client-port-rate 3 lane 3 client-type 10GE
RP/0/RP0/CPU0:ios(config-hwmod-mxp)#client-port-rate 3 lane 4 client-type 10GE
RP/0/RP0/CPU0:ios(config-hwmod-mxp)#client-port-rate 4 lane 1 client-type 10GE
RP/0/RP0/CPU0:ios(config-hwmod-mxp)#client-port-rate 4 lane 2 client-type 10GE
RP/0/RP0/CPU0:ios(config-hwmod-mxp)#client-port-rate 4 lane 3 client-type 10GE
RP/0/RP0/CPU0:ios(config-hwmod-mxp)#client-port-rate 4 lane 4 client-type 10GE
RP/0/RP0/CPU0:ios(config-hwmod-mxp)#client-port-rate 5 lane 1 client-type 10GE
RP/0/RP0/CPU0:ios(config-hwmod-mxp)#client-port-rate 5 lane 2 client-type 10GE
RP/0/RP0/CPU0:ios(config-hwmod-mxp)#client-port-rate 5 lane 3 client-type 10GE
RP/0/RP0/CPU0:ios(config-hwmod-mxp)#client-port-rate 5 lane 4 client-type 10GE
RP/0/RP0/CPU0:ios(config-hwmod-mxp)#client-port-rate 6 lane 1 client-type 10GE
RP/0/RP0/CPU0:ios(config-hwmod-mxp)#client-port-rate 6 lane 2 client-type 10GE
RP/0/RP0/CPU0:ios(config-hwmod-mxp)#client-port-rate 6 lane 3 client-type 10GE
RP/0/RP0/CPU0:ios(config-hwmod-mxp)#client-port-rate 6 lane 4 client-type 10GE
RP/0/RP0/CPU0:ios(config-hwmod-mxp)#client-port-rate 7 lane 1 client-type 10GE
RP/0/RP0/CPU0:ios(config-hwmod-mxp)#client-port-rate 7 lane 2 client-type 10GE
RP/0/RP0/CPU0:ios(config-hwmod-mxp)#client-port-rate 7 lane 3 client-type 10GE
RP/0/RP0/CPU0:ios(config-hwmod-mxp)#client-port-rate 7 lane 4 client-type 10GE
RP/0/RP0/CPU0:ios(config-hwmod-mxp)#client-port-rate 9 lane 1 client-type 10GE
RP/0/RP0/CPU0:ios(config-hwmod-mxp)#client-port-rate 9 lane 2 client-type 10GE
RP/0/RP0/CPU0:ios(config-hwmod-mxp)#client-port-rate 9 lane 3 client-type 10GE
RP/0/RP0/CPU0:ios(config-hwmod-mxp)#client-port-rate 9 lane 4 client-type 10GE
RP/0/RP0/CPU0:ios(config-hwmod-mxp)#client-port-rate 11 lane 1 client-type 10GE
RP/0/RP0/CPU0:ios(config-hwmod-mxp)#client-port-rate 11 lane 2 client-type 10GE
RP/0/RP0/CPU0:ios(config-hwmod-mxp)#client-port-rate 11 lane 3 client-type 10GE
```

```
RP/0/RP0/CPU0:ios(config-hwmod-mxp)#client-port-rate 11 lane 4 client-type 10GE
RP/0/RP0/CPU0:ios(config-hwmod-mxp)#commit
```

### Verifying the Muxponder Configuration

The following is a sample to verify the 40x10G muxponder configuration in the OTN-XP card.

```
RP/0/RP0/CPU0:ios#show hw-module location 0/3 muxponder
Wed Jun 2 17:57:36.647 UTC
```

```
Location:                0/3
Slice ID:                 0
Client Bitrate:          10GE
Trunk Bitrate:           400G
Status:                  Provisioned
LLDP Drop Enabled:       FALSE
ARP Snoop Enabled:       FALSE
Client Port              Mapper/Trunk Port          CoherentDSP0/3/0/12
                          Traffic Split Percentage

TenGigECtrlr0/3/0/0/1    ODU2E0/3/0/12/0/1          100
TenGigECtrlr0/3/0/0/2    ODU2E0/3/0/12/0/2          100
TenGigECtrlr0/3/0/0/3    ODU2E0/3/0/12/0/3          100
TenGigECtrlr0/3/0/0/4    ODU2E0/3/0/12/0/4          100
TenGigECtrlr0/3/0/1/1    ODU2E0/3/0/12/1/1          100
TenGigECtrlr0/3/0/1/2    ODU2E0/3/0/12/1/2          100
TenGigECtrlr0/3/0/1/3    ODU2E0/3/0/12/1/3          100
TenGigECtrlr0/3/0/1/4    ODU2E0/3/0/12/1/4          100
TenGigECtrlr0/3/0/2/1    ODU2E0/3/0/12/2/1          100
TenGigECtrlr0/3/0/2/2    ODU2E0/3/0/12/2/2          100
TenGigECtrlr0/3/0/2/3    ODU2E0/3/0/12/2/3          100
TenGigECtrlr0/3/0/2/4    ODU2E0/3/0/12/2/4          100
TenGigECtrlr0/3/0/3/1    ODU2E0/3/0/12/3/1          100
TenGigECtrlr0/3/0/3/2    ODU2E0/3/0/12/3/2          100
TenGigECtrlr0/3/0/3/3    ODU2E0/3/0/12/3/3          100
TenGigECtrlr0/3/0/3/4    ODU2E0/3/0/12/3/4          100
TenGigECtrlr0/3/0/4/1    ODU2E0/3/0/12/4/1          100
TenGigECtrlr0/3/0/4/2    ODU2E0/3/0/12/4/2          100
TenGigECtrlr0/3/0/4/3    ODU2E0/3/0/12/4/3          100
TenGigECtrlr0/3/0/4/4    ODU2E0/3/0/12/4/4          100
TenGigECtrlr0/3/0/5/1    ODU2E0/3/0/12/5/1          100
TenGigECtrlr0/3/0/5/2    ODU2E0/3/0/12/5/2          100
TenGigECtrlr0/3/0/5/3    ODU2E0/3/0/12/5/3          100
TenGigECtrlr0/3/0/5/4    ODU2E0/3/0/12/5/4          100
TenGigECtrlr0/3/0/6/1    ODU2E0/3/0/12/6/1          100
TenGigECtrlr0/3/0/6/2    ODU2E0/3/0/12/6/2          100
TenGigECtrlr0/3/0/6/3    ODU2E0/3/0/12/6/3          100
TenGigECtrlr0/3/0/6/4    ODU2E0/3/0/12/6/4          100
TenGigECtrlr0/3/0/7/1    ODU2E0/3/0/12/7/1          100
TenGigECtrlr0/3/0/7/2    ODU2E0/3/0/12/7/2          100
TenGigECtrlr0/3/0/7/3    ODU2E0/3/0/12/7/3          100
TenGigECtrlr0/3/0/7/4    ODU2E0/3/0/12/7/4          100
TenGigECtrlr0/3/0/9/1    ODU2E0/3/0/12/9/1          100
TenGigECtrlr0/3/0/9/2    ODU2E0/3/0/12/9/2          100
TenGigECtrlr0/3/0/9/3    ODU2E0/3/0/12/9/3          100
TenGigECtrlr0/3/0/9/4    ODU2E0/3/0/12/9/4          100
TenGigECtrlr0/3/0/11/1   ODU2E0/3/0/12/11/1         100
TenGigECtrlr0/3/0/11/2   ODU2E0/3/0/12/11/2         100
TenGigECtrlr0/3/0/11/3   ODU2E0/3/0/12/11/3         100
TenGigECtrlr0/3/0/11/4   ODU2E0/3/0/12/11/4         100
```

## Configuring the Muxponder Mode for 30x10G

To configure the OTN-XP card in the 30x10G muxponder mode, use the following commands:

**configure**

**hw-module location** *location* **mxponder-slice** *mxponder-slice-number*

**trunk-rate 300G**

**client-port-rate** *client-port-number* **lane** *lane-number* **client-type** {10GE | OTU2E | OTU2}

**commit**

### Example

The following is a sample in which the OTN-XP card is configured with 300G trunk rate on the mxponder-slice 0 mode.

```
RP/0/RP0/CPU0:ios#config
Tue Apr 21 09:21:44.460 UTC
RP/0/RP0/CPU0:ios(config)#hw-module location 0/1 mxponder-slice 0
RP/0/RP0/CPU0:ios(config-hwmod-mxp)#trunk-rate 300G
RP/0/RP0/CPU0:ios(config-hwmod-mxp)#client-port-rate 0 lane 1 client-type 10GE
RP/0/RP0/CPU0:ios(config-hwmod-mxp)#client-port-rate 0 lane 2 client-type OTU2E
RP/0/RP0/CPU0:ios(config-hwmod-mxp)#client-port-rate 0 lane 3 client-type OTU2
RP/0/RP0/CPU0:ios(config-hwmod-mxp)#client-port-rate 0 lane 4 client-type 10GE
RP/0/RP0/CPU0:ios(config-hwmod-mxp)#client-port-rate 1 lane 1 client-type 10GE
RP/0/RP0/CPU0:ios(config-hwmod-mxp)#client-port-rate 1 lane 2 client-type OTU2E
RP/0/RP0/CPU0:ios(config-hwmod-mxp)#client-port-rate 1 lane 3 client-type OTU2
RP/0/RP0/CPU0:ios(config-hwmod-mxp)#client-port-rate 1 lane 4 client-type 10GE
RP/0/RP0/CPU0:ios(config-hwmod-mxp)#client-port-rate 2 lane 1 client-type 10GE
RP/0/RP0/CPU0:ios(config-hwmod-mxp)#client-port-rate 2 lane 2 client-type OTU2E
RP/0/RP0/CPU0:ios(config-hwmod-mxp)#client-port-rate 2 lane 3 client-type OTU2
RP/0/RP0/CPU0:ios(config-hwmod-mxp)#client-port-rate 2 lane 4 client-type 10GE
RP/0/RP0/CPU0:ios(config-hwmod-mxp)#client-port-rate 3 lane 1 client-type 10GE
RP/0/RP0/CPU0:ios(config-hwmod-mxp)#client-port-rate 3 lane 2 client-type OTU2E
RP/0/RP0/CPU0:ios(config-hwmod-mxp)#client-port-rate 3 lane 3 client-type OTU2
RP/0/RP0/CPU0:ios(config-hwmod-mxp)#client-port-rate 3 lane 4 client-type 10GE
RP/0/RP0/CPU0:ios(config-hwmod-mxp)#client-port-rate 4 lane 1 client-type 10GE
RP/0/RP0/CPU0:ios(config-hwmod-mxp)#client-port-rate 4 lane 2 client-type OTU2E
RP/0/RP0/CPU0:ios(config-hwmod-mxp)#client-port-rate 4 lane 3 client-type OTU2
RP/0/RP0/CPU0:ios(config-hwmod-mxp)#client-port-rate 4 lane 4 client-type 10GE
RP/0/RP0/CPU0:ios(config-hwmod-mxp)#client-port-rate 5 lane 1 client-type 10GE
RP/0/RP0/CPU0:ios(config-hwmod-mxp)#client-port-rate 5 lane 2 client-type OTU2E
RP/0/RP0/CPU0:ios(config-hwmod-mxp)#client-port-rate 5 lane 3 client-type OTU2
RP/0/RP0/CPU0:ios(config-hwmod-mxp)#client-port-rate 5 lane 4 client-type 10GE
RP/0/RP0/CPU0:ios(config-hwmod-mxp)#client-port-rate 9 lane 1 client-type 10GE
RP/0/RP0/CPU0:ios(config-hwmod-mxp)#client-port-rate 9 lane 2 client-type OTU2E
RP/0/RP0/CPU0:ios(config-hwmod-mxp)#client-port-rate 9 lane 3 client-type OTU2
RP/0/RP0/CPU0:ios(config-hwmod-mxp)#client-port-rate 9 lane 4 client-type 10GE
RP/0/RP0/CPU0:ios(config-hwmod-mxp)#client-port-rate 11 lane 1 client-type 10GE
RP/0/RP0/CPU0:ios(config-hwmod-mxp)#client-port-rate 11 lane 2 client-type OTU2E
RP/0/RP0/CPU0:ios(config-hwmod-mxp)#commit
```

### Verifying the Muxponder Configuration

The following is a sample to verify the 30x10G muxponder configuration in the OTN-XP card.

```
RP/0/RP0/CPU0:ios#show hw-module location 0/1 mxponder
Wed Jun 2 17:56:40.574 UTC
```



```

Location:                0/1
Slice ID:                0
Client Bitrate:          MIXED
Trunk Bitrate:           300G
Status:                  Provisioned
LLDP Drop Enabled:      FALSE
ARP Snoop Enabled:      FALSE
Client Port              Mapper/Trunk Port   Peer/Trunk Port       CoherentDSP0/1/0/12

                        Traffic Split Percentage

OTU20/1/0/0/3          NONE          ODU20/1/0/12/0/3
  100
OTU20/1/0/1/3          NONE          ODU20/1/0/12/1/3
  100
OTU20/1/0/2/3          NONE          ODU20/1/0/12/2/3
  100
OTU20/1/0/3/3          NONE          ODU20/1/0/12/3/3
  100
OTU20/1/0/4/3          NONE          ODU20/1/0/12/4/3
  100
OTU20/1/0/5/3          NONE          ODU20/1/0/12/5/3
  100
OTU20/1/0/9/3          NONE          ODU20/1/0/12/9/3
  100
OTU2E0/1/0/0/2          NONE          ODU2E0/1/0/12/0/2
  100
OTU2E0/1/0/1/2          NONE          ODU2E0/1/0/12/1/2
  100
OTU2E0/1/0/2/2          NONE          ODU2E0/1/0/12/2/2
  100
OTU2E0/1/0/3/2          NONE          ODU2E0/1/0/12/3/2
  100
OTU2E0/1/0/4/2          NONE          ODU2E0/1/0/12/4/2
  100
OTU2E0/1/0/5/2          NONE          ODU2E0/1/0/12/5/2
  100
OTU2E0/1/0/9/2          NONE          ODU2E0/1/0/12/9/2
  100
TenGigEctr0/1/0/0/1      ODU2E0/1/0/12/0/1      NONE
  100
TenGigEctr0/1/0/0/4      ODU2E0/1/0/12/0/4      NONE
  100
TenGigEctr0/1/0/1/1      ODU2E0/1/0/12/1/1      NONE
  100
TenGigEctr0/1/0/1/4      ODU2E0/1/0/12/1/4      NONE
  100
TenGigEctr0/1/0/2/1      ODU2E0/1/0/12/2/1      NONE
  100
TenGigEctr0/1/0/2/4      ODU2E0/1/0/12/2/4      NONE
  100
TenGigEctr0/1/0/3/1      ODU2E0/1/0/12/3/1      NONE
  100
TenGigEctr0/1/0/3/4      ODU2E0/1/0/12/3/4      NONE
  100
TenGigEctr0/1/0/4/1      ODU2E0/1/0/12/4/1      NONE
  100
TenGigEctr0/1/0/4/4      ODU2E0/1/0/12/4/4      NONE
  100
TenGigEctr0/1/0/5/1      ODU2E0/1/0/12/5/1      NONE
  100
TenGigEctr0/1/0/5/4      ODU2E0/1/0/12/5/4      NONE
  100
  
```

TenGigECtrlr0/1/0/9/1 100	ODU2E0/1/0/12/9/1	NONE
TenGigECtrlr0/1/0/9/4 100	ODU2E0/1/0/12/9/4	NONE

## Configuring Hybrid Modes Using 40x10G-4x100G-MXP

**Table 6: Feature History**

Feature Name	Release Information	Description
Hybrid Modes Using 40x10G-4x100G-MXP	Cisco IOS XR Release 7.3.2	<p>With the 40x10G-4x100G-MXP muxponder mode support, you can configure the following hybrid modes:</p> <ul style="list-style-type: none"> <li>• 20x10G + 2x100G</li> <li>• 10x10G + 3 x 100G</li> </ul> <p>With the 40x10G-4x100G-MXP muxponder mode support, you have flexibility to choose a combination of 10G and 100G client rates across different OTN and Ethernet client rates.</p>

With the 40x10G-4x100G-MXP muxponder mode support, you can configure the following hybrid modes:

- 20x10G + 2x100G
- 10x10G + 3 x 100G

For more information on the client to trunk mapping for each of the mode, see [#unique\\_6 unique\\_6\\_Connect\\_42\\_table\\_yft\\_mn1\\_srb](#).

### Configuring the Muxponder Mode for 20x10G-2x100G

To configure the OTN-XP card in the 20x10G-2x100G muxponder mode, use the following commands:

**configure**

**hw-module location** *location* **mxponder-slice** *mxponder-slice-number*

**trunk-rate** 400G

**client-port-rate** *client-port-number* **client-type** {100GE | OTU4}

**client-port-rate** *client-port-number* **lane** *lane-number* **client-type** {10GE | OTU2 | OTU2E}

**commit**

#### Example

The following is a sample in which the OTN-XP card is configured with 400G trunk rate on the mxponder-slice 0 mode.

```

RP/0/RP0/CPU0:ios#config
Tue Apr 21 09:21:44.460 UTC
RP/0/RP0/CPU0:ios(config)#hw-module location 0/1 mxponder-slice 0
RP/0/RP0/CPU0:ios(config-hwmod-mxp)#trunk-rate 400G
RP/0/RP0/CPU0:ios(config-hwmod-mxp)#client-port-rate 0 client-type 100GE
RP/0/RP0/CPU0:ios(config-hwmod-mxp)#client-port-rate 1 client-type OTU4
RP/0/RP0/CPU0:ios(config-hwmod-mxp)#client-port-rate 2 lane 3 client-type OTU2E
RP/0/RP0/CPU0:ios(config-hwmod-mxp)#client-port-rate 2 lane 4 client-type OTU2E
RP/0/RP0/CPU0:ios(config-hwmod-mxp)#client-port-rate 4 lane 1 client-type OTU2E
RP/0/RP0/CPU0:ios(config-hwmod-mxp)#client-port-rate 4 lane 2 client-type OTU2E
RP/0/RP0/CPU0:ios(config-hwmod-mxp)#client-port-rate 4 lane 3 client-type OTU2E
RP/0/RP0/CPU0:ios(config-hwmod-mxp)#client-port-rate 4 lane 4 client-type OTU2E
RP/0/RP0/CPU0:ios(config-hwmod-mxp)#client-port-rate 5 lane 1 client-type OTU2E
RP/0/RP0/CPU0:ios(config-hwmod-mxp)#client-port-rate 5 lane 2 client-type OTU2E
RP/0/RP0/CPU0:ios(config-hwmod-mxp)#client-port-rate 5 lane 3 client-type OTU2E
RP/0/RP0/CPU0:ios(config-hwmod-mxp)#client-port-rate 5 lane 4 client-type OTU2E
RP/0/RP0/CPU0:ios(config-hwmod-mxp)#client-port-rate 6 lane 1 client-type 10GE
RP/0/RP0/CPU0:ios(config-hwmod-mxp)#client-port-rate 6 lane 2 client-type 10GE
RP/0/RP0/CPU0:ios(config-hwmod-mxp)#client-port-rate 6 lane 3 client-type 10GE
RP/0/RP0/CPU0:ios(config-hwmod-mxp)#client-port-rate 6 lane 4 client-type 10GE
RP/0/RP0/CPU0:ios(config-hwmod-mxp)#client-port-rate 7 lane 1 client-type 10GE
RP/0/RP0/CPU0:ios(config-hwmod-mxp)#client-port-rate 7 lane 2 client-type 10GE
RP/0/RP0/CPU0:ios(config-hwmod-mxp)#client-port-rate 7 lane 3 client-type 10GE
RP/0/RP0/CPU0:ios(config-hwmod-mxp)#client-port-rate 7 lane 4 client-type 10GE
RP/0/RP0/CPU0:ios(config-hwmod-mxp)#client-port-rate 11 lane 3 client-type 10GE
RP/0/RP0/CPU0:ios(config-hwmod-mxp)#client-port-rate 11 lane 4 client-type 10GE
RP/0/RP0/CPU0:ios(config-hwmod-mxp)#commit

```

### Verifying the Muxponder Configuration

The following is a sample to verify the 20x10G-2x100G muxponder configuration in the OTN-XP card.

```

RP/0/RP0/CPU0:ios#show hw-module location 0/1 mxponder
Wed Jun 2 18:00:58.201 UTC

```

```

Location:                0/1
Slice ID:                0
Client Bitrate:         MIXED
Trunk Bitrate:          400G
Status:                 Provisioned
LLDP Drop Enabled:     FALSE
ARP Snoop Enabled:     FALSE
Client Port              Mapper/Trunk Port   Peer/Trunk Port           CoherentDSP0/1/0/12
                        Traffic Split Percentage
OTU40/1/0/1             NONE      ODU40/1/0/12/1           100
OTU2E0/1/0/2/3         NONE      ODU2E0/1/0/12/2/3
100
OTU2E0/1/0/2/4         NONE      ODU2E0/1/0/12/2/4
100
OTU2E0/1/0/4/1         NONE      ODU2E0/1/0/12/4/1
100
OTU2E0/1/0/4/2         NONE      ODU2E0/1/0/12/4/2
100
OTU2E0/1/0/4/3         NONE      ODU2E0/1/0/12/4/3
100
OTU2E0/1/0/4/4         NONE      ODU2E0/1/0/12/4/4
100
OTU2E0/1/0/5/1         NONE      ODU2E0/1/0/12/5/1
100
OTU2E0/1/0/5/2         NONE      ODU2E0/1/0/12/5/2
100

```

OTU2E0/1/0/5/3 100	NONE	ODU2E0/1/0/12/5/3	
OTU2E0/1/0/5/4 100	NONE	ODU2E0/1/0/12/5/4	
TenGigEctrler0/1/0/6/1	ODU2E0/1/0/12/6/1		100
TenGigEctrler0/1/0/6/2	ODU2E0/1/0/12/6/2		100
TenGigEctrler0/1/0/6/3	ODU2E0/1/0/12/6/3		100
TenGigEctrler0/1/0/6/4	ODU2E0/1/0/12/6/4		100
TenGigEctrler0/1/0/7/1	ODU2E0/1/0/12/7/1		100
TenGigEctrler0/1/0/7/2	ODU2E0/1/0/12/7/2		100
TenGigEctrler0/1/0/7/3	ODU2E0/1/0/12/7/3		100
TenGigEctrler0/1/0/7/4	ODU2E0/1/0/12/7/4		100
TenGigEctrler0/1/0/11/3	ODU2E0/1/0/12/11/3		100
TenGigEctrler0/1/0/11/4	ODU2E0/1/0/12/11/4		100
HundredGigEctrler0/1/0/0	ODU40/1/0/12/0	NONE	100

### Configuring the Muxponder Mode for 10 x 10G-3 x 100G

To configure the OTN-XP card in the 10 x 10G and 3 x 100G muxponder mode, use the following commands:

**configure**

**hw-module location** *location* **mxponder-slice** *mxponder-slice-number*

**trunk-rate** 400G

**client-port-rate** *client-port-number* **client-type** {100GE | OTU4}

**client-port-rate** *client-port-number* **lane** *lane-number* **client-type** {10GE | OTU2 | OTU2E}

**commit**

#### Example

The following is a sample in which the OTN-XP card is configured with 400G trunk rate on the mxponder-slice 0 mode.

```
RP/0/RP0/CPU0:ios#config
Tue Apr 21 09:21:44.460 UTC
RP/0/RP0/CPU0:ios(config)#hw-module location 0/1 mxponder-slice 0
RP/0/RP0/CPU0:ios(config-hwmod-mxp)#trunk-rate 400G
RP/0/RP0/CPU0:ios(config-hwmod-mxp)#client-port-rate 0 client-type 100GE
RP/0/RP0/CPU0:ios(config-hwmod-mxp)#client-port-rate 1 client-type OTU4
RP/0/RP0/CPU0:ios(config-hwmod-mxp)#client-port-rate 2 lane 3 client-type OTU2E
RP/0/RP0/CPU0:ios(config-hwmod-mxp)#client-port-rate 2 lane 4 client-type OTU2E
RP/0/RP0/CPU0:ios(config-hwmod-mxp)#client-port-rate 4 lane 1 client-type OTU2E
RP/0/RP0/CPU0:ios(config-hwmod-mxp)#client-port-rate 4 lane 2 client-type OTU2E
RP/0/RP0/CPU0:ios(config-hwmod-mxp)#client-port-rate 4 lane 3 client-type OTU2E
RP/0/RP0/CPU0:ios(config-hwmod-mxp)#client-port-rate 4 lane 4 client-type OTU2E
RP/0/RP0/CPU0:ios(config-hwmod-mxp)#client-port-rate 5 lane 1 client-type OTU2E
RP/0/RP0/CPU0:ios(config-hwmod-mxp)#client-port-rate 5 lane 2 client-type OTU2E
RP/0/RP0/CPU0:ios(config-hwmod-mxp)#client-port-rate 5 lane 3 client-type OTU2E
RP/0/RP0/CPU0:ios(config-hwmod-mxp)#client-port-rate 5 lane 4 client-type OTU2E
RP/0/RP0/CPU0:ios(config-hwmod-mxp)#client-port-rate 6 client-type 100GE
RP/0/RP0/CPU0:ios(config-hwmod-mxp)#commit
```

#### Verifying the Muxponder Configuration

The following is a sample to verify the 10 x 10G and 3 x 100G muxponder configuration in the OTN-XP card.

```
RP/0/RP0/CPU0:ios#show hw-module location 0/1 muxponder
Wed Jun 2 18:00:58.201 UTC
```

```
Location:          0/1
Slice ID:          0
Client Bitrate:   MIXED
Trunk Bitrate:    400G
Status:           Provisioned
LLDP Drop Enabled: FALSE
ARP Snoop Enabled: FALSE
Client Port                               Mapper/Trunk Port   Peer/Trunk Port     CoherentDSP0/1/0/12
Traffic Split Percentage

OTU40/1/0/1                               NONE               ODU40/1/0/12/1     100
OTU2E0/1/0/2/3                             NONE               ODU2E0/1/0/12/2/3
100
OTU2E0/1/0/2/4                             NONE               ODU2E0/1/0/12/2/4
100
OTU2E0/1/0/4/1                             NONE               ODU2E0/1/0/12/4/1
100
OTU2E0/1/0/4/2                             NONE               ODU2E0/1/0/12/4/2
100
OTU2E0/1/0/4/3                             NONE               ODU2E0/1/0/12/4/3
100
OTU2E0/1/0/4/4                             NONE               ODU2E0/1/0/12/4/4
100
OTU2E0/1/0/5/1                             NONE               ODU2E0/1/0/12/5/1
100
OTU2E0/1/0/5/2                             NONE               ODU2E0/1/0/12/5/2
100
OTU2E0/1/0/5/3                             NONE               ODU2E0/1/0/12/5/3
100
OTU2E0/1/0/5/4                             NONE               ODU2E0/1/0/12/5/4
100
HundredGigEctrlr0/1/0/0                   ODU40/1/0/12/0    NONE                100
HundredGigEctrlr0/1/0/6                   ODU40/1/0/12/6    NONE                100
```

## Configuring the Muxponder Mode for 200G on OTN-XP Card

Table 7: Feature History

Feature Name	Release Information	Description
Muxponder Configuration for 200G Trunk with QPSK and 8QAM Modulation	Cisco IOS XR Release 7.3.2	The OTN-XP card supports up to 200G trunk rate with QPSK and 8QAM modulation using CFP2. This feature enhances the signal reachability with reduced noise and can support the 50GHz network.  Commands modified: <ul style="list-style-type: none"><li>hw-module (OTN-XP Card)</li></ul>

To configure the OTN-XP card in the 200G muxponder mode, use the following commands:

**configure**

**hw-module location** *location* **mxponder-slice** *mxponder-slice-number*

**trunk-rate** 200G

**commit**

The following is a sample configuration of 200G trunk rate on the mxponder-slice 0 mode for OTN-XP card:

```
RP/0/RP0/CPU0:ios#config
Wed Jun  2 17:17:59.409 UTC
RP/0/RP0/CPU0:ios(config)#hw-module location 0/1 mxponder-slice 0
RP/0/RP0/CPU0:ios(config-hwmod-mxp)#trunk-rate 200G
RP/0/RP0/CPU0:ios(config-hwmod-mxp)#client-port-rate 7 client-type 100GE
RP/0/RP0/CPU0:ios(config-hwmod-mxp)#client-port-rate 10 client-type 100GE
RP/0/RP0/CPU0:ios(config-hwmod-mxp)#commit
```

The following is a sample configuration of 200G trunk rate on the mxponder-slice 1 mode for OTN-XP card:

```
RP/0/RP0/CPU0:ios#config
Wed Jun  2 17:17:59.409 UTC
RP/0/RP0/CPU0:ios(config)#hw-module location 0/1 mxponder-slice 1
RP/0/RP0/CPU0:ios(config-hwmod-mxp)#trunk-rate 200G
RP/0/RP0/CPU0:ios(config-hwmod-mxp)#client-port-rate 5 client-type 100GE
RP/0/RP0/CPU0:ios(config-hwmod-mxp)#client-port-rate 8 client-type 100GE
RP/0/RP0/CPU0:ios(config-hwmod-mxp)#commit
```

The following is the sample output for verifying the supported client rates for each trunk rate configured in muxponder slice 0:

```
RP/0/RP0/CPU0:ios#show hw-module location 0/1 xponder-capabilities mxponder-slice 0
Wed Jun  2 17:02:33.088 UTC
```

Location: 0/1

Trunk-Port(s): 12

```
Port Group Restrictions:
Shared-Client-Group-Bandwidth      Shared-Group-Client-Ports
      400G                          1, 6, 7, 10
```

```
Trunk-bandwidth: 400G
Client-port      Supported client rates
      1           OTU4, 100GE
      6           OTU4, 100GE
      7           OTU4, 100GE
      10          OTU4, 100GE, 400GE
```

```
Trunk-bandwidth: 300G
Client-port      Supported client rates
      6           OTU4, 100GE
      7           OTU4, 100GE
      10          OTU4, 100GE
```

```
Trunk-bandwidth: 200G
Client-port      Supported client rates
      7           OTU4, 100GE
      10          OTU4, 100GE
```

The following is the sample output for verifying the supported client rates for each trunk rate configured in muxponder slice 1:

```
RP/0/RP0/CPU0:ios#show hw-module location 0/1 xponder-capabilities mxponder-slice 1
Wed Jun  2 17:02:50.133 UTC
```

```

Location: 0/1

Trunk-Port(s): 13

Port Group Restrictions:
Shared-Client-Group-Bandwidth      Shared-Group-Client-Ports
    400G                             0, 4, 5, 8

Trunk-bandwidth: 400G
Client-port                          Supported client rates
    0                                 OTU4, 100GE
    4                                 OTU4, 100GE
    5                                 OTU4, 100GE
    8                                 OTU4, 100GE, 400GE

Trunk-bandwidth: 300G
Client-port                          Supported client rates
    4                                 OTU4, 100GE
    5                                 OTU4, 100GE
    8                                 OTU4, 100GE

Trunk-bandwidth: 200G
Client-port                          Supported client rates
    5                                 OTU4, 100GE
    8                                 OTU4, 100GE
    
```

### Configuring 8QAM Modulation for 200G Muxponder Mode

By default, QPSK is the modulation format, when you configure 200G trunk rate. The following operating modes are supported on the DP04CFP2 coherent pluggable module:

**Table 8: DP04CFP2 Supported Modes**

Network Configuration Mode	Client Type	Trunk Rate	Data Path	Line Framing	FEC Type	Modulation Format	BPS	Baud Rate (GBd)	Pulse Shaping	Mode Type
200G-FOIC2-oFEC-QPSK-1-S (Default mode)	2xFOIC1.2	200G	FlexO Str	FlexO-2	oFEC	QPSK	2	63.1	1	Standard
200G-FOIC2-oFEC-8QAM-1-E	2xFOIC1.2	200G	FlexO Str	FlexO-2	oFEC	8QAM	3	42.1	1	Enhanced

Use the following commands to change the modulation format to 8QAM:

```

configure
controller optics Rack/Slot/Instance/Port bits-per-symbol 3
commit
    
```

The following is a sample in which 8QAM modulation is configured.

```

RP/0/RP0/CPU0:ios#config
Wed Jun  2 17:21:59.409 UTC
RP/0/RP0/CPU0:ios(config)#controller optics0/1/0/12 bits-per-symbol 3
RP/0/RP0/CPU0:ios(config-optics)#commit
    
```

## Verifying the 8QAM Modulation Configuration

```

RP/0/RP0/CPU0:ios#show controllers optics 0/1/0/12
Wed Jun  2 17:17:29.652 UTC

Controller State: Up

Transport Admin State: In Service

Laser State: On

LED State: Green

Optics Status

  Optics Type: <Unknown> DWDM
  DWDM carrier Info: C BAND, MSA ITU Channel=61, Frequency=193.10THz,
  Wavelength=1552.524nm

  Alarm Status:
  -----
  Detected Alarms: None

  LOS/LOL/Fault Status:

  Alarm Statistics:

  -----
  HIGH-RX-PWR = 0          LOW-RX-PWR = 1
  HIGH-TX-PWR = 0          LOW-TX-PWR = 1
  HIGH-LBC = 0             HIGH-DGD = 0
  OOR-CD = 0               OSNR = 1
  WV-OOO = 0               MEA = 0
  IMPROPER-REM = 0
  TX-POWER-PROV-MISMATCH = 0
  Laser Bias Current = 0.0 %
  Actual TX Power = 0.97 dBm
  RX Power = 1.47 dBm
  RX Signal Power = 17.67 dBm
  Frequency Offset = 82 MHz

  Performance Monitoring: Enable

  THRESHOLD VALUES
  -----

  Parameter                High Alarm  Low Alarm  High Warning  Low Warning
  -----
  Rx Power Threshold(dBm)   3.0        -31.5     0.0           0.0
  Tx Power Threshold(dBm)   3.0        -12.0     0.0           0.0
  LBC Threshold(mA)         N/A        N/A       0.00          0.00

  LBC High Threshold = 90 %
  Configured Tx Power = 1.00 dBm
  Configured CD High Threshold = 96000 ps/nm
  Configured CD lower Threshold = -96000 ps/nm
  Configured OSNR lower Threshold = 13.70 dB
  Configured DGD Higher Threshold = 67.00 ps
  Baud Rate = 42.2082633972 GBd
  Bits per Symbol = 3.0000000000 bits/symbol
  Modulation Type: 8QAM
  Chromatic Dispersion 2 ps/nm

```



```

Configured CD-MIN -48000 ps/nm  CD-MAX 48000 ps/nm
Polarization Mode Dispersion = 0.0 ps
Second Order Polarization Mode Dispersion = 72.00 ps^2
Optical Signal to Noise Ratio = 34.10 dB
SNR = 18.40 dB
Polarization Dependent Loss = 1.20 dB
Polarization Change Rate = 0.00 rad/s
Differential Group Delay = 2.00 ps

```

#### Transceiver Vendor Details

```

Form Factor           : Not set
Fiber Connector Type: Not Set
Otn Application Code: Not Set
Sonet Application Code: Not Set
Ethernet Compliance Code: Not set

```

Transceiver Temperature : 46 Celsius

```

AINS Soak           : None
AINS Timer          : 0h, 0m
AINS remaining time : 0 seconds

```

## Configuring the Muxponder Mode for 300G on OTN-XP Card

**Table 9: Feature History**

Feature Name	Release Information	Description
Muxponder Configuration for 300G Trunk with 8QAM Modulation	Cisco IOS XR Release 7.3.2	The OTN-XP card supports up to 300G trunk rate with 8QAM modulation using CFP2. This feature improves the signal reachability with decreased noise.  Commands modified: <ul style="list-style-type: none"><li>hw-module (OTN-XP Card)</li></ul>

To configure the OTN-XP card in the 300G muxponder mode, use the following commands:

**configure**

**hw-module location** *location* **mxponder-slice** *mxponder-slice-number*

**trunk-rate 300G**

**commit**

The following is a sample configuration of 300G trunk rate on the mxponder-slice 0 mode for OTN-XP card:

```

RP/0/RP0/CPU0:ios#config
Wed Jun  2 17:17:59.409 UTC
RP/0/RP0/CPU0:ios(config)#hw-module location 0/1 mxponder-slice 0
RP/0/RP0/CPU0:ios(config-hwmod-mxp)#trunk-rate 300G
RP/0/RP0/CPU0:ios(config-hwmod-mxp)#client-port-rate 6 client-type 100GE
RP/0/RP0/CPU0:ios(config-hwmod-mxp)#client-port-rate 7 client-type 100GE

```

```
RP/0/RP0/CPU0:ios(config-hwmod-mxp)#client-port-rate 10 client-type 100GE
RP/0/RP0/CPU0:ios(config-hwmod-mxp)#commit
```

The following is a sample configuration of 300G trunk rate on the mxponder-slice 1 mode for OTN-XP card:

```
RP/0/RP0/CPU0:ios#config
Wed Jun  2 17:17:59.409 UTC
RP/0/RP0/CPU0:ios(config)#hw-module location 0/1 mxponder-slice 1
RP/0/RP0/CPU0:ios(config-hwmod-mxp)#trunk-rate 300G
RP/0/RP0/CPU0:ios(config-hwmod-mxp)#client-port-rate 4 client-type 100GE
RP/0/RP0/CPU0:ios(config-hwmod-mxp)#client-port-rate 5 client-type 100GE
RP/0/RP0/CPU0:ios(config-hwmod-mxp)#client-port-rate 8 client-type 100GE
RP/0/RP0/CPU0:ios(config-hwmod-mxp)#commit
```

The following is the sample output for verifying the supported client rates for each trunk rate configured in muxponder slice 0:

```
RP/0/RP0/CPU0:ios#show hw-module location 0/1 xponder-capabilities mxponder-slice 0
Wed Jun  2 17:02:33.088 UTC
```

Location: 0/1

Trunk-Port(s): 12

```
Port Group Restrictions:
Shared-Client-Group-Bandwidth      Shared-Group-Client-Ports
400G                                1, 6, 7, 10
```

```
Trunk-bandwidth: 400G
Client-port                          Supported client rates
1                                     OTU4, 100GE
6                                     OTU4, 100GE
7                                     OTU4, 100GE
10                                    OTU4, 100GE, 400GE
```

```
Trunk-bandwidth: 300G
Client-port                          Supported client rates
6                                     OTU4, 100GE
7                                     OTU4, 100GE
10                                    OTU4, 100GE
```

```
Trunk-bandwidth: 200G
Client-port                          Supported client rates
7                                     OTU4, 100GE
10                                    OTU4, 100GE
```

The following is the sample output for verifying the supported client rates for each trunk rate configured in muxponder slice 1:

```
RP/0/RP0/CPU0:ios#show hw-module location 0/1 xponder-capabilities mxponder-slice 1
Wed Jun  2 17:02:50.133 UTC
```

Location: 0/1

Trunk-Port(s): 13

```
Port Group Restrictions:
Shared-Client-Group-Bandwidth      Shared-Group-Client-Ports
400G                                0, 4, 5, 8
```

```
Trunk-bandwidth: 400G
Client-port                          Supported client rates
0                                     OTU4, 100GE
4                                     OTU4, 100GE
```

```

5 OTU4, 100GE
8 OTU4, 100GE, 400GE

Trunk-bandwidth: 300G
Client-port Supported client rates
4 OTU4, 100GE
5 OTU4, 100GE
8 OTU4, 100GE

Trunk-bandwidth: 200G
Client-port Supported client rates
5 OTU4, 100GE
8 OTU4, 100GE
    
```

By default, 8QAM is the modulation format, when you configure 300G trunk rate.

The following operating mode is supported on the DP04CFP2 coherent pluggable module:

**Table 10: DP04CFP2 Supported Modes**

Network Configuration Mode	Client Type	Trunk Rate	Data Path	Line Framing	FEC Type	Modulation Format	BPS	Baud Rate (GBd)	Pulse Shaping	Mode Type
300G-FOIC3-oFEC-8QAM-1-S (Default mode)	3xFOIC1.2	300G	FlexO Str	FlexO-3	oFEC	8QAM	3	63.1	1	Standard

The following sample shows the supported client rates for 300G trunk rate and the provisioning status of slice 1:

```

RP/0/RP0/CPU0:ios#show hw-module location 0/1 mxponder-slice 1
Fri Jul 23 16:04:42.279 UTC

Location: 0/1
Slice ID: 1
Client Bitrate: 100GE
Trunk Bitrate: 300G
Status: Provisioned
LLDP Drop Enabled: FALSE
ARP Snoop Enabled: FALSE
Client Port Mapper/Trunk Port CoherentDSP0/1/0/13
Traffic Split Percentage
HundredGigECtrlr0/1/0/4 ODU40/1/0/13/8 100
HundredGigECtrlr0/1/0/5 ODU40/1/0/13/5 100
HundredGigECtrlr0/1/0/8 ODU40/1/0/13/8 100
    
```

The following sample shows the default 8QAM modulation format for the 300G trunk rate:

```

RP/0/RP0/CPU0:ios#show controllers optics 0/1/0/12
Wed Jun 2 17:17:29.652 UTC

Controller State: Up

Transport Admin State: In Service

Laser State: On

LED State: Green

Optics Status
    
```

Optics Type: <Unknown> DWDM  
 DWDM carrier Info: C BAND, MSA ITU Channel=61, Frequency=193.10THz,  
 Wavelength=1552.524nm

Alarm Status:

-----  
 Detected Alarms: None

LOS/LOL/Fault Status:

Alarm Statistics:

-----  
 HIGH-RX-PWR = 0                      LOW-RX-PWR = 1  
 HIGH-TX-PWR = 0                      LOW-TX-PWR = 1  
 HIGH-LBC = 0                         HIGH-DGD = 0  
 OOR-CD = 0                            OSNR = 1  
 WVL-OOL = 0                         MEA = 0  
 IMPROPER-REM = 0  
 TX-POWER-PROV-MISMATCH = 0  
 Laser Bias Current = 0.0 %  
 Actual TX Power = 0.97 dBm  
 RX Power = 1.47 dBm  
 RX Signal Power = 17.67 dBm  
 Frequency Offset = 82 MHz

Performance Monitoring: Enable

THRESHOLD VALUES

Parameter	High Alarm	Low Alarm	High Warning	Low Warning
Rx Power Threshold(dBm)	3.0	-31.5	0.0	0.0
Tx Power Threshold(dBm)	3.0	-12.0	0.0	0.0
LBC Threshold(mA)	N/A	N/A	0.00	0.00

LBC High Threshold = 90 %  
 Configured Tx Power = 1.00 dBm  
 Configured CD High Threshold = 96000 ps/nm  
 Configured CD lower Threshold = -96000 ps/nm  
 Configured OSNR lower Threshold = 13.70 dB  
 Configured DGD Higher Threshold = 67.00 ps  
 Baud Rate = 42.2082633972 GBd  
**Bits per Symbol = 3.0000000000 bits/symbol**  
**Modulation Type: 8QAM**  
 Chromatic Dispersion 2 ps/nm  
 Configured CD-MIN -48000 ps/nm CD-MAX 48000 ps/nm  
 Polarization Mode Dispersion = 0.0 ps  
 Second Order Polarization Mode Dispersion = 72.00 ps^2  
 Optical Signal to Noise Ratio = 34.10 dB  
 SNR = 18.40 dB  
 Polarization Dependent Loss = 1.20 dB  
 Polarization Change Rate = 0.00 rad/s  
 Differential Group Delay = 2.00 ps

Transceiver Vendor Details

Form Factor                            : Not set  
 Fiber Connector Type: Not Set  
 Otn Application Code: Not Set  
 Sonet Application Code: Not Set  
 Ethernet Compliance Code: Not set

Transceiver Temperature : 46 Celsius

AINS Soak : None  
 AINS Timer : 0h, 0m  
 AINS remaining time : 0 seconds

## Configuring the Muxponder Mode for 4x100GE-MXP-DD

**Table 11: Feature History**

Feature Name	Release Information	Description
4X100GE MXP modes with QDD ZRP for OTN-XP Card	Cisco IOS XR Release 7.3.2	On the OTN-XP card, you can configure a single 4x100GE payload that is received over the client port as a 400GE signal over DWDM on the line side.  The card improves efficiency, performance, and flexibility for customer networks allowing 4x100GE client transport over 400GE WDM wavelength.

From Release 7.3.2 onwards, you can configure the 4x100GE-MXP-DD muxponder mode on the OTN-XP card.

### Restrictions for Port Group Mapping - 4X100GE-MXP-DD

The following table explains about the port mapping when the mxponder-slice 0 is at the near end and is connected to the mxponder-slice 1 at the far end:

**Table 12: Port Group Mapping**

Slice Configuration - Client Port	Shared-Client-Group-Bandwidth	Shared-Group-Client-Ports
Slice 0	400G	1, 6, 7, 10
Slice 1	400G	8, 0, 4, 5

The traffic flows from the near-end slice-0 to the far-end slice-1 client ports:

- The port 1 traffic reaches port 8
- The port 6 traffic reaches port 0
- The port 7 traffic reaches port 4
- The port 10 traffic reaches port 5

The following table describes the QSFP DD trunk port to the slice-0 client port and slice-1 client port mapping:

Table 13: QSFP DD Trunk Port to the Slice-0 and Slice-1 Client Port Mapping

QSFP-DD Trunk Port	Slice 0 - Client Port	Slice 1 - Client Port
0	Port 10	Port 5
1	Port 7	Port 4
2	Port 6	Port 0
3	Port 1	Port 8

### Configuring the Muxponder Mode for 4x100GE-MXP-DD

To configure the OTN-XP card in the 4x100GE-MXP-DD muxponder mode, use the following commands:

**configure**

**hw-module location** *location* **mxponder-slice** *mxponder-slice-number*

**trunk-rate** 400G

**client-port-rate** *client-port-number* **client-type** 100GE

**commit**

#### Example

The following is a sample in which the OTN-XP card is configured with 400G trunk rate on the mxponder-slice 0 mode.

```
RP/0/RP0/CPU0:ios#configure
Tue Jun 15 20:20:17.227 UTC
RP/0/RP0/CPU0:ios(config)#hw-module location 0/0 mxponder-slice 0
RP/0/RP0/CPU0:ios(config-hwmod-mxp)#trunk-rate 400G
RP/0/RP0/CPU0:ios(config-hwmod-mxp)#client-port-rate 1 client-type 100GE
RP/0/RP0/CPU0:ios(config-hwmod-mxp)#client-port-rate 6 client-type 100GE
RP/0/RP0/CPU0:ios(config-hwmod-mxp)#client-port-rate 7 client-type 100GE
RP/0/RP0/CPU0:ios(config-hwmod-mxp)#client-port-rate 10 client-type 100GE
RP/0/RP0/CPU0:ios(config-hwmod-mxp)#commit
Tue Jun 15 20:20:57.532 UTC
```

#### Verifying the Muxponder Configuration

The following is a sample to verify the 4x100GE-MXP-DD muxponder configuration in the OTN-XP card.

```
RP/0/RP0/CPU0:ios#show hw-module location 0/0 mxponder
Tue Jun 15 20:21:46.587 UTC

Location:                0/0
Slice ID:                 0
Client Bitrate:          100GE
Trunk Bitrate:           400G
Status:                  Provisioned
LLDP Drop Enabled:      FALSE
ARP Snoop Enabled:      FALSE
Client Port              Mapper/Trunk Port      CoherentDSP0/0/0/11
                        Traffic Split Percentage
```

```
HundredGigECtrlr0/0/0/1      -      100
HundredGigECtrlr0/0/0/6      -      100
HundredGigECtrlr0/0/0/7      -      100
HundredGigECtrlr0/0/0/10     -      100
```

The following is a sample in which the OTN-XP card is configured with 400G trunk rate on the mxponder-slice 1 mode.

```
RP/0/RP0/CPU0:ios#configure
Tue Jun 15 20:22:13.981 UTC
RP/0/RP0/CPU0:ios(config)#hw-module location 0/0 mxponder-slice 1
RP/0/RP0/CPU0:ios(config-hwmod-mxp)#trunk-rate 400G
RP/0/RP0/CPU0:ios(config-hwmod-mxp)#client-port-rate 0 client-type 100GE
RP/0/RP0/CPU0:ios(config-hwmod-mxp)#client-port-rate 4 client-type 100GE
RP/0/RP0/CPU0:ios(config-hwmod-mxp)#client-port-rate 5 client-type 100GE
RP/0/RP0/CPU0:ios(config-hwmod-mxp)#client-port-rate 8 client-type 100GE
RP/0/RP0/CPU0:ios(config-hwmod-mxp)#commit
```

### Verifying the Muxponder Configuration

The following is a sample to verify the 4x100GE-MXP-DD muxponder configuration in the OTN-XP card.

```
RP/0/RP0/CPU0:ios#show hw-module location 0/0 mxponder-slice 1
Tue Jun 15 20:23:06.217 UTC

Location:          0/0
Slice ID:          1
Client Bitrate:    100GE
Trunk Bitrate:     400G
Status:            Provisioned
LLDP Drop Enabled: FALSE
ARP Snoop Enabled: FALSE
Client Port                Mapper/Trunk Port                CoherentDSP0/0/0/9
                           Traffic Split Percentage

HundredGigECtrlr0/0/0/0      -      100
HundredGigECtrlr0/0/0/4      -      100
HundredGigECtrlr0/0/0/5      -      100
HundredGigECtrlr0/0/0/8      -      100
```

```
RP/0/RP0/CPU0:ios#show hw-module location 0/0 mxponder
Tue Jun 15 20:23:46.650 UTC

Location:          0/0
Slice ID:          0
Client Bitrate:    100GE
Trunk Bitrate:     400G
Status:            Provisioned
LLDP Drop Enabled: FALSE
ARP Snoop Enabled: FALSE
Client Port                Mapper/Trunk Port                CoherentDSP0/0/0/11
                           Traffic Split Percentage

HundredGigECtrlr0/0/0/1      -      100
HundredGigECtrlr0/0/0/6      -      100
HundredGigECtrlr0/0/0/7      -      100
HundredGigECtrlr0/0/0/10     -      100
```

```
Location:          0/0
```

```

Slice ID:          1
Client Bitrate:   100GE
Trunk Bitrate:    400G
Status:           Provisioned
LLDP Drop Enabled: FALSE
ARP Snoop Enabled: FALSE
Client Port                               Mapper/Trunk Port      CoherentDSP0/0/0/9
Traffic Split Percentage

HundredGigECtrlr0/0/0/0                   -                      100
HundredGigECtrlr0/0/0/4                   -                      100
HundredGigECtrlr0/0/0/5                   -                      100
HundredGigECtrlr0/0/0/8                   -                      100

```

## Configuring Inverse Muxponder on OTN-XP Card for 400GE Client

Table 14: Feature History

Feature Name	Release Information	Feature Description
Inverse Muxponder Configuration on OTN-XP Card	Cisco IOS XR Release 7.3.2	<p>The OTN-XP card supports inverse multiplexing for 400GE client over 2x200G CFP2 trunk ports. This feature allows you to split the 400GE client signal and carry it over 2x200G trunks thereby increasing the ease of signal reachability.</p> <p>Commands modified:</p> <ul style="list-style-type: none"> <li>hw-module (OTN-XP Card)</li> <li>controller coherentDSP</li> </ul>

You can configure the OTN-XP card to support inverse multiplexing for 400GE client over 2x200G CFP2 trunk ports. To configure the inverse muxponder datapath, use the following commands:

**configure**

**hw-module location** *location*

**mxponder**

**trunk-rate 200G**

**client-port-rate** *client-port-number* **client-type 400GE**

**commit**

**end**

The following sample configures inverse muxponder for 400G:

```

RP/0/RP0/CPU0:ios #Configure
RP/0/RP0/CPU0:ios(config)#hw-module location 0/0 mxponder
RP/0/RP0/CPU0:ios(config-hwmod-mxp)#trunk-rate 200G
RP/0/RP0/CPU0:ios(config-hwmod-mxp)#client-port-rate 10 client-type 400GE
RP/0/RP0/CPU0:ios(config-hwmod-mxp)#commit

```



The following sample verifies the inverse muxponder configuration:

```
RP/0/RP0/CPU0:ios#show hw-module location 0/0 mxponder
Wed Jun 9 23:16:59.478 UTC

Location:                0/0
Client Bitrate:          400GE
Trunk Bitrate:           200G
Status:                  Provisioned
LLDP Drop Enabled:       FALSE
ARP Snoop Enabled:       FALSE
Client Port              Mapper/Trunk Port      CoherentDSP0/0/0/12
CoherentDSP0/0/0/13

Traffic Split Percentage

FourHundredGigEctrlr0/0/0/10 ODU-FLEX0/0/0/12/10      50      50
```

### Alarm Correlation in Inverse Muxponder

When any service-affecting alarm is raised on the trunk port 12 or 13, the alarms are reported on the ports as follows:

- Port 12—Flexo alarms (FLEXO\_LOS, FLEXO\_LOL, FLEXO\_GIDM, FLEXO\_FMM, FLEXO\_LOF, and FLEXO\_LOM) and OTU alarms (LOD, AIS, LOS, LOM, LOD, and TIM)
- Port 13—Flexo alarms except Flexo MM and GIDM.

Both ports 12 and 13 go down when any service-affecting alarm is raised.

#### Example:

Shut down the trunk port 12:

```
RP/0/RP0/CPU0:ios(config)#controller coherentDSP 0/3/0/12
RP/0/RP0/CPU0:ios(config-CoDSP)#shutdown
RP/0/RP0/CPU0:ios(config-CoDSP)#commit
Thu Sep 30 14:12:48.416 UTC
```

The following sample verifies that when trunk port 12 is shut down, LOS alarm is raised and the trunk port 13 also goes down.

```
RP/0/RP0/CPU0:ios#show controllers coherentDSP 0/2/0/12
Thu Sep 30 14:12:54.604 UTC

Port                : CoherentDSP 0/2/0/12
Controller State    : Down
Inherited Secondary State : Normal
Configured Secondary State : Normal
Derived State       : In Service
Loopback mode       : None
BER Thresholds      : SF = 1.0E-5  SD = 1.0E-7
Performance Monitoring : Enable
Bandwidth           : 200.0Gb/s

Alarm Information:
LOS = 2 LOF = 0 LOM = 0
OOF = 1 OOM = 0 AIS = 1
IAE = 0 BIAE = 0      SF_BER = 0
SD_BER = 0      BDI = 0 TIM = 0
FECMISMATCH = 0 FEC-UNC = 0  FLEXO_GIDM = 0
FLEXO-MM = 0  FLEXO-LOM = 0  FLEXO-RDI = 1
FLEXO-LOF = 0
Detected Alarms    : LOS
```

```

Bit Error Rate Information
  PREFEC BER           : 0.00E+00
  POSTFEC BER          : 0.00E+00
  Q-Factor             : 0.00 dB

  Q-Margin             : 0.00dB

  TTI :
    Remote IP addr     : 0.0.0.0

  FEC mode              : O_FEC

  Flexo-Mode           : Enable
  Flexo Details:
    Tx GID              : 1
    TX IID              : 1, 2,
    Rx GID              : 0
    RX IID              : 0, 0,

  Flexo Peers Information:
    Controller          : CoherentDSP0_2_0_13
    OTUCn rate          : OTUC2

  AINS Soak            : None
  AINS Timer           : 0h, 0m
  AINS remaining time  : 0 seconds

RP/0/RP0/CPU0:ios#show controllers coherentDSP 0/2/0/13
Thu Sep 30 14:12:59.330 UTC

Port                    : CoherentDSP 0/2/0/13
Controller State        : Down
Inherited Secondary State : Normal
Configured Secondary State : Normal
Derived State           : In Service
Loopback mode           : None
BER Thresholds          : SF = 1.0E-5  SD = 1.0E-7
Performance Monitoring  : Enable
Bandwidth                : 200.0Gb/s

Alarm Information:
LOS = 1 LOF = 0 LOM = 0
OOF = 0 OOM = 0 AIS = 0
IAE = 0 BIAE = 0      SF_BER = 0
SD_BER = 0      BDI = 0 TIM = 0
FECMISMATCH = 0 FEC-UNC = 0      FLEXO_GIDM = 0
FLEXO-MM = 0      FLEXO-LOM = 0  FLEXO-RDI = 1
FLEXO-LOF = 0
Detected Alarms         : None

Bit Error Rate Information
  PREFEC BER           : 0.00E+00
  POSTFEC BER          : 0.00E+00
  Q-Factor             : 15.80 dB

  Q-Margin             : 9.50dB

  TTI :
    Remote IP addr     : 0.0.0.0

  FEC mode              : O_FEC

```

```

Flexo-Mode                               : Enable
Flexo Details:
  Tx GID                                  : 1
  TX IID                                  : 3, 4,
  Rx GID                                  : 1
  RX IID                                  : 3, 4,

Flexo Peers Information:
  Controller                               : CoherentDSP0_2_0_12
  OTUCn rate                              : OTUC2

AINS Soak                                 : None
AINS Timer                                : 0h, 0m
AINS remaining time                       : 0 seconds

```

You can perform the following configurations on the DSPcontroller ports:

- [Flexo Parameter Update on Inverse Muxponder Configuration on the OTN-XP Card, on page 146](#)
- [Configure TTI on Inverse Muxponder Configuration on the OTN-XP Card](#)
- [Configure Loopback in Inverse Muxponder Configured on the OTN-XP Card](#)

## 2-QDD-C Line Card

**Table 15: Feature History**

Feature Name	Release Information	Description
NCS1K4-2-QDD-C-K9 C-Band Line Card	Cisco IOS XR Release 7.3.1	<p>NCS 1004 supports the NCS1K4-2-QDD-C-K9 C-Band line card. The card has eight client ports (QSFP28 and QSFP-DD) and two DWDM dual sub-channel module trunk ports. Each trunk port is capable of 200, 300, and 400 Gbps line rate with fine control of modulation format, baud-rate, and forward error correction. The trunk ports are software configurable. The line card supports module and slice configurations.</p> <p>Command added:</p> <ul style="list-style-type: none"> <li>• <b>controller fourHundredGigECtrlr</b></li> </ul>

The following section describes the supported configurations and procedures to configure the card modes on the 2-QDD-C line card.

## Limitations for 2-QDD-C

- Flex Ethernet is not supported.
- A single 400GE cannot be split and use as 4x 100GE due to hardware limitations.

## Unsupported Features for 2-QDD-C in R731

The following features are not supported in R7.3.1 for 2-QDD-C card:

- OTU4 client
- Layer 1 encryption
- GCC remote node management
- Line rates of 50G, 100G, 150G, 250G, and 350G

## 2-QDD-C Card Modes

The 2-QDD-C line cards support module and slice configurations.

The line cards have two trunk ports (0 and 1) and 8 client ports (2 through 9) each. You can configure the line card in two modes:

- Muxponder—In this mode, both trunk ports are configured with the same trunk rate. The client-to-trunk mapping is in a sequence in vertical order.
- Muxponder slice—In this mode, each trunk port is configured independent of the other with different trunk rates. The client-to-trunk mapping is fixed in vertical order. For Trunk 0, the client ports are 2 through 5. For Trunk 1, the client ports are 6 through 9.

## Supported Data Rates for 2-QDD-C Card

The following table displays the client and trunk ports that are enabled for the muxponder configuration.

Trunk Data Rate	Card Support	Client Data Rate	Client Optics	Trunk Ports	Client Ports
200	2-QDD-C	100GE, OTU4	QSFP-28	0, 1	2, 3, 4, 5
300	2-QDD-C	100GE, OTU4	QSFP-28	0, 1	2, 3, 4, 5, 6, 7
400	2-QDD-C	100GE, OTU4	QSFP-28	0, 1	2, 3, 4, 5, 6, 7, 8, 9
200	2-QDD-C	400GE	QSFP-DD	0, 1	4
400	2-QDD-C	400GE	QSFP-DD	0, 1	4,8

The following table displays the client and trunk ports that are enabled for the muxponder slice 0 configuration.

Trunk Data Rate	Card Support	Client Data Rate	Trunk Ports	Client Ports
200	2-QDD-C	100GE, OTU4	0	2, 3

Trunk Data Rate	Card Support	Client Data Rate	Trunk Ports	Client Ports
300	2-QDD-C	100GE, OTU4	0	2, 3, 4
400	2-QDD-C	100GE, OTU4	0	2, 3, 4, 5
400	2-QDD-C	400GE	0	4

The following table displays the client and trunk ports that are enabled for the muxponder slice 1 configuration.

Trunk Data Rate	Card Support	Client Data Rate	Trunk Ports	Client Ports
200	2-QDD-C	100GE, OTU4	1	6, 7
300	2-QDD-C	100GE, OTU4	1	6, 7, 8
400	2-QDD-C	100GE, OTU4	1	6, 7, 8, 9
400	2-QDD-C	400GE	1	8

The following table displays the trunk parameter ranges for the 2-QDD-C card.

Trunk Payload	FEC	Min BPS	Max BPS	Min GBd	Max GBd
150G	27%	1.453125	4.335938	24.02079	71.67494
200G	27%	2	4.40625	31.51	69.43
250G	27%	2.414063	6	28.93129	71.9069
300G	27%	2.8984375	6	34.7175497	71.8681352
350G	27%	3.382813	6	40.5038	71.84047
400G	27%	3.8671875	6	46.2900663	71.8197392
150G	15%	1.320313	3.9375	24.02079	71.67494
200G	15%	1.7578125	5.25	24.02079115	71.74209625
250G	15%	2.195313	6	26.27274	71.80592
300G	15%	3.8203125	6	31.52728839	49.51525048
350G	15%	3.070313	6	36.78184	71.87901
400G	15%	3.8671875	6	42.03638452	71.9018782



**Note** The recommended value for 6 BPS for corresponding line rates are listed below:

Trunk Payload	FEC	BPS	GBd
300G	27%	6	34.7175
350G	27%	6	40.5038
400G	15%	6	42.0364

For more information on the QDD-C card, see the [data sheet](#).

## Configuring the Card Mode for 2-QDD-C Card

From R7.3.1, you can configure the 2-QDD-C line card in the module (muxponder) or slice configuration (muxponder slice).

To configure the card in the muxponder mode, use the following commands:

- **configure**

```
hw-module location location mxponder client-rate {100GE | OTU4 }
```

```
hw-module location location mxponder trunk-rate {100G | 150G | 200G | 250G | 300G | 350G | 400G }
```

```
commit
```

- **configure**

```
hw-module location location mxponder client-rate { 400GE }
```

```
hw-module location location mxponder trunk-rate { 200G | 400G }
```

```
commit
```

To configure the card in the muxponder slice mode, use the following commands.

**configure**

```
hw-module location location mxponder-slice mxponder-slice-number client-rate { 100GE | 400GE }
```

```
hw-module location location mxponder-slice mxponder-slice-number trunk-rate { 100G | 200G | 300G | 400G }
```

```
commit
```

### Examples

The following is a sample in which the card is configured in the muxponder mode with a 400G trunk rate.

```
RP/0/RP0/CPU0:ios#config
Tue Oct 15 01:24:56.355 UTC
RP/0/RP0/CPU0:ios(config)#hw-module location 0/1 mxponder client-rate 100GE
RP/0/RP0/CPU0:ios(config)#hw-module location 0/1 mxponder trunk-rate 400G
RP/0/RP0/CPU0:ios(config)#commit
```

The following is a sample in which the card is configured in the muxponder slice 0 mode with a 400G trunk rate.

```
RP/0/RP0/CPU0:ios#config
RP/0/RP0/CPU0:ios(config)#hw-module location 0/1 mxponder-slice 0 client-rate 100GE
RP/0/RP0/CPU0:ios(config)#hw-module location 0/1 mxponder-slice 0 trunk-rate 400G
RP/0/RP0/CPU0:ios(config)#commit
```

The following is a sample in which the card is configured in the muxponder slice 1 mode with a 400G trunk rate.

```
RP/0/RP0/CPU0:ios#config
RP/0/RP0/CPU0:ios(config)#hw-module location 0/1 mxponder-slice 1 client-rate 100GE
RP/0/RP0/CPU0:ios(config)#hw-module location 0/1 mxponder-slice 1 trunk-rate 400G
RP/0/RP0/CPU0:ios(config)#commit
```

The following is a sample in which the card is configured in the muxponder mode with a 400GE trunk rate.

```
RP/0/RP0/CPU0:west#configure
Thu Oct 7 11:43:01.914 IST
RP/0/RP0/CPU0:west(config)#hw-module location 0/2 mxponder trunk-rate 4
400G 450G
RP/0/RP0/CPU0:west(config)#hw-module location 0/2 mxponder trunk-rate 400G
RP/0/RP0/CPU0:west(config)#hw-module location 0/2 mxponder client-rate 400GE
RP/0/RP0/CPU0:west(config)#commit
```







## CHAPTER 3

# Configuring Controllers

There are three types of controllers for the line card. The controllers are the optics controller, the ethernet controller, and the coherent DSP controller. This chapter describes the procedures used to configure these controllers.



---

**Note** Unless otherwise specified, “line cards” refers to 1.2T and 1.2TL line cards.

---

- [AINS, on page 64](#)
- [FEC, on page 72](#)
- [Laser Squelching, on page 79](#)
- [Idle Insertion, on page 83](#)
- [LLDP Drop, on page 86](#)
- [Link Layer Discovery Protocol \(LLDP\) Support on Management Interface, on page 90](#)
- [DHCP Client, on page 94](#)
- [MAC Address Snooping on Client Ports, on page 97](#)
- [Transmit Shutdown, on page 99](#)
- [Loopback, on page 102](#)
- [Restore Factory Settings, on page 113](#)
- [Headless Mode, on page 114](#)
- [Trail Trace Identifier, on page 114](#)
- [Chromatic Dispersion, on page 120](#)
- [Transmit Power, on page 122](#)
- [Laser Bias Current High Threshold, on page 125](#)
- [Differential Group Delay Threshold, on page 127](#)
- [Optical Signal to Noise Ratio, on page 129](#)
- [Chromatic Dispersion Threshold, on page 131](#)
- [Receive Power Threshold, on page 133](#)
- [Transmit Power Threshold, on page 135](#)
- [Frequency, on page 137](#)
- [Pseudo Random Binary Sequence, on page 137](#)
- [FlexO GID and IID, on page 145](#)

# AINS

The Automatic-In-Service (AINS) feature allows the controller to automatically move to the automatic-in-service state after the maintenance window is completed. A soak time period is associated with the AINS state. The controller automatically moves to the In-Service state after the soak time period is completed. During the AINS maintenance window, alarms are not propagated to the EMS/NMS monitoring system.

You can configure AINS on the client ports of the card.

## AINS States

The following table lists the AINS states.

State	Description
None	AINS is not enabled on the controller or the soak time period is complete.
Pending	AINS is configured on the controller. However, the soak time period has not started because either the primary state of controller is in Shutdown, Admin down, or Not ready state or the secondary state is in Maintenance state. AINS can also move to Pending state if alarms are raised during the soak time period.
Running	AINS is enabled on the controller. The primary state of the controller is Up and the secondary state is AINS.

If there are any service-affecting alarms when AINS is running on ethernet or optics controllers, the AINS state moves to Pending state. When the alarms are cleared, the AINS state moves to Running state.

The AINS soak time period restarts when there are line card reloads, XR reloads, line card warm reloads, power cycles, or alarm conditioning.

## Soak Time Period

You can configure the soak time period to be between 1 minute to 48 hours.

All alarms are suppressed during the AINS state. When the optical and ethernet alarms are raised on the port during the soak time period, the AINS state moves to Pending. These alarms are not displayed in the output of the **show alarms brief card location 0/RP0/CPU0 active** command but in the output of the **show alarms brief card location 0/RP0/CPU0 conditions** command. When all the alarms clear, the soak time period starts, and the AINS state moves to Running. When the soak time period expires, the port moves to IS state.

## Configuring AINS

To configure AINS on a muxponder, use the following command:

```
configure
hw-module location location mxponder client-port-ains-soak hours hours minutes minutes
commit
```

The following is a sample in which all client ports are configured with AINS with soak time period specified to be 15 minutes.

```
RP/0/RP0/CPU0:ios#configure
RP/0/RP0/CPU0:ios(config)#hw-module location 0/3 mxponder client-port-ains-soak hours 0
minutes 15
RP/0/RP0/CPU0:ios(config)#commit
```

To configure AINS on a muxponder slice, use the following command:

#### **configure**

**hw-module location** *location* **mxponder-slice** *slice-number* **client-port-ains-soak hours** *hours* **minutes** *minutes*

#### **commit**

The following is a sample in which slice 0 client ports are configured with AINS with soak time period specified to be 40 minutes.

```
RP/0/RP0/CPU0:ios#configure
RP/0/RP0/CPU0:ios(config)#hw-module location 0/3 mxponder-slice 0 client-port-ains-soak
hours 0 minutes 40
RP/0/RP0/CPU0:ios(config)#commit
```

## Disabling AINS

To disable AINS on all muxponder client ports, set the hours and minutes to 0. Use the following commands:

#### **configure**

**hw-module location** *location* **mxponder** **client-port-ains-soak hours** *hours* **minutes** *minutes*

#### **commit**

The following is a sample in which AINS is disabled on all client ports.

```
RP/0/RP0/CPU0:ios#configure
RP/0/RP0/CPU0:ios(config)#hw-module location 0/3 mxponder client-port-ains-soak hours 0
minutes 0
RP/0/RP0/CPU0:ios(config)#commit
```

To disable AINS on a muxponder slice, set the hours and minutes to 0. Use the following command:

#### **configure**

**hw-module location** *location* **mxponder-slice** *slice-number* **client-port-ains-soak hours** *hours* **minutes** *minutes*

#### **commit**

The following is a sample in which AINS is disabled on all client ports of slice 0.

```
RP/0/RP0/CPU0:ios#configure
RP/0/RP0/CPU0:ios(config)#hw-module location 0/3 mxponder-slice 0 client-port-ains-soak
hours 0 minutes 0
RP/0/RP0/CPU0:ios(config)#commit
```

## Displaying the AINS Configuration

The AINS Soak field in the output indicates the current state of AINS. The current state can be None, Pending, or Running. The Total Duration field indicates the total soak time period that is configured. The Remaining Duration field indicates the soak time that remains, after which, the AINS state moves to None.

This example displays the ethernet controller statistics with AINS Soak in running state.

```
RP/0/RP0/CPU0:ios#show controller HundredGigECtrlr 0/1/0/2
Thu Feb 21 19:52:55.001 UTC
Operational data for interface HundredGigECtrlr0/1/0/2:
```

```
State:
  Administrative state: enabled
  Operational state: Up
  LED state: Green On
  Maintenance: Disabled
  AINS Soak: Running
    Total Duration: 0 hour(s) 15 minute(s)
    Remaining Duration: 0 hour(s) 5 minute(s) 37 second(s)
  Laser Squelch: Disabled
```

```
Phy:
  Media type: Not known
```

Autonegotiation disabled.

```
Operational values:
  Speed: 100Gbps
  Duplex: Full Duplex
  Flowcontrol: None
  Loopback: None (or external)
  BER monitoring:
    Not supported
  Holdoff Time: 0ms
```

This example displays the ethernet controller statistics with AINS Soak in pending state.

```
RP/0/RP0/CPU0:ios#show controllers HuC 0/0/0/2
Thu Mar 12 13:52:12.129 UTC
Operational data for interface HundredGigECtrlr0/0/0/2:
```

```
State:
  Administrative state: enabled
  Operational state: Down (Reason: State undefined)
  LED state: Red On
  Maintenance: Disabled
  AINS Soak: Pending
    Total Duration: 0 hour(s) 30 minute(s)
    Remaining Duration: 0 hour(s) 30 minute(s) 0 second(s)
  Laser Squelch: Disabled
```

```
Phy:
  Media type: Not known
  Alarms:
    Current:
      Local Fault
  Statistics:
    FEC:
      Corrected Codeword Count: 0
      Uncorrected Codeword Count: 9
```

Autonegotiation disabled.

```
Operational values:
  Speed: 100Gbps
  Duplex: Full Duplex
  Flowcontrol: None
  Loopback: None (or external)
  BER monitoring:
    Not supported
  Forward error correction: Standard (Reed-Solomon)
  Holdoff Time: 0ms
```

This example displays the optics controller statistics with AINS Soak in running state.

```
RP/0/RP0/CPU0:ios#show controller optics 0/1/0/3
```

```
Thu Feb 21 19:45:41.088 UTC
```

```
Controller State: Up
```

```
Transport Admin State: Automatic In Service
```

```
Laser State: On
```

```
LED State: Green
```

```
Optics Status
```

```
  Optics Type: Grey optics
```

```
  Alarm Status:
```

```
  -----
```

```
  Detected Alarms: None
```

```
  LOS/LOL/Fault Status:
```

```
  Alarm Statistics:
```

```
  -----
```

```
  HIGH-RX-PWR = 0          LOW-RX-PWR = 0
  HIGH-TX-PWR = 0          LOW-TX-PWR = 0
  HIGH-LBC = 0            HIGH-DGD = 0
  OOR-CD = 0              OSNR = 0
  WVL-OOL = 0            MEA = 0
  IMPROPER-REM = 0
  TX-POWER-PROV-MISMATCH = 0
```

```
  Performance Monitoring: Enable
```

```
  THRESHOLD VALUES
```

```
  -----
```

Parameter	High Alarm	Low Alarm	High Warning	Low Warning
Rx Power Threshold(dBm)	4.9	-12.0	0.0	0.0
Tx Power Threshold(dBm)	3.5	-10.1	0.0	0.0
LBC Threshold(mA)	N/A	N/A	0.00	0.00

```
LBC High Threshold = 98 %
Polarization parameters not supported by optics
```

```
Total TX Power = 6.39 dBm
```

```
Total RX Power = 5.85 dBm
```

Lane	Laser Bias	TX Power	RX Power	Output Frequency
1	75.0 %	0.59 dBm	0.63 dBm	230.43 THz
2	68.6 %	0.06 dBm	-0.68 dBm	230.43 THz
3	69.0 %	0.26 dBm	-0.63 dBm	230.43 THz
4	69.1 %	0.56 dBm	-0.10 dBm	230.43 THz

## Transceiver Vendor Details

```

Form Factor           : QSFP28
Name                  : CISCO-FINISAR
Part Number           : FTLC1152RGPL-C2
Rev Number            : CISCO-FINISAR
Serial Number         : FNS22150LEC
PID                   : QSFP-100G-CWDM4-S
VID                   : V02
CISCO-FINISAR
Date Code (yy/mm/dd) : 18/04/11
Fiber Connector Type: LC
Sonet Application Code: Not Set
Ethernet Compliance Code: 100GBASE-CWDM4

```

Transceiver Temperature : 32 Celsius

```

AINS Soak           : Running
AINS Timer         : 0h, 15m
AINS remaining time : 771 seconds

```

When the soak time expires, AINS state changes from Running to None. The Transport Admin State of optics controller changes from Automatic In Service to In Service.

```
RP/0/RP0/CPU0:ios# show controllers optics 0/1/0/3
```

Thu Feb 21 20:02:34.126 UTC

Controller State: Up

**Transport Admin State: In Service**

Laser State: On

LED State: Green

Optics Status

Optics Type: Grey optics

Alarm Status:

-----  
Detected Alarms: None

LOS/LOL/Fault Status:

Alarm Statistics:

```

-----
HIGH-RX-PWR = 0          LOW-RX-PWR = 0
HIGH-TX-PWR = 0          LOW-TX-PWR = 0
HIGH-LBC = 0             HIGH-DGD = 0
OOR-CD = 0               OSNR = 0
WVL-OOL = 0              MEA = 0

```

```

IMPROPER-REM = 0
TX-POWER-PROV-MISMATCH = 0

```

```
Performance Monitoring: Enable
```

```
THRESHOLD VALUES
-----
```

Parameter	High Alarm	Low Alarm	High Warning	Low Warning
Rx Power Threshold(dBm)	4.9	-12.0	0.0	0.0
Tx Power Threshold(dBm)	3.5	-10.1	0.0	0.0
LBC Threshold(mA)	N/A	N/A	0.00	0.00

```

LBC High Threshold = 98 %
Polarization parameters not supported by optics

```

```
Total TX Power = 6.41 dBm
```

```
Total RX Power = 5.85 dBm
```

Lane	Laser Bias	TX Power	RX Power	Output Frequency
1	74.9 %	0.60 dBm	0.63 dBm	230.43 THz
2	68.6 %	0.06 dBm	-0.70 dBm	230.43 THz
3	69.0 %	0.30 dBm	-0.63 dBm	230.43 THz
4	69.1 %	0.57 dBm	-0.11 dBm	230.43 THz

```
Transceiver Vendor Details
```

```

Form Factor           : QSFP28
Name                  : CISCO-FINISAR
Part Number           : FTLC1152RGPL-C2
Rev Number            : CISCO-FINISAR
Serial Number         : FNS22150LEC
PID                   : QSFP-100G-CWDM4-S
VID                   : V02
CISCO-FINISAR
Date Code(yy/mm/dd)  : 18/04/11
Fiber Connector Type : LC
Sonet Application Code: Not Set
Ethernet Compliance Code: 100GBASE-CWDM4

```

```
Transceiver Temperature : 32 Celsius
```

```

AINS Soak             : None
AINS Timer             : 0h, 0m
AINS remaining time   : 0 seconds

```

## Configuring AINS on OTN-XP Card

You can configure the default AINS settings for all controllers on the OTN-XP card using the shared plane configuration. The configuration is applied to any line card that is installed in the NCS 1004. Use the following commands:

```
configure
```

```
ains-soak hours hours minutes minutes
```

```
commit
```

The following is a sample in which all the controllers on the OTN-XP card are configured with AINS with soak time period specified to be two minutes.

```

RP/0/RP0/CPU0:ios#configure
RP/0/RP0/CPU0:ios(config)#ains-soak hours 0 minutes 2
RP/0/RP0/CPU0:ios(config)#commit
RP/0/RP0/CPU0:ios(config)#do show controllers optics 0/1/0/0
Tue Apr 28 11:50:15.431 UTC

Controller State: Down

Transport Admin State: Automatic In Service

Laser State: On

LED State: Red

Optics Status

    Optics Type: 100G QSFP28 LR4

    Alarm Status:
    -----
    Detected Alarms: None

    LOS/LOL/Fault Status:

    Alarm Statistics:

    -----
    HIGH-RX-PWR = 0           LOW-RX-PWR = 0
    HIGH-TX-PWR = 0           LOW-TX-PWR = 0
    HIGH-LBC = 0              HIGH-DGD = 0
    OOR-CD = 0                 OSNR = 0
    WVL-OOL = 0                MEA = 0
    IMPROPER-REM = 0
    TX-POWER-PROV-MISMATCH = 0

    Performance Monitoring: Enable

    THRESHOLD VALUES
    -----

    Parameter                High Alarm  Low Alarm  High Warning  Low Warning
    -----
    Rx Power Threshold(dBm)   4.9         -12.0      0.0           0.0
    Tx Power Threshold(dBm)   3.5         -10.1      0.0           0.0
    LBC Threshold(mA)         N/A         N/A        0.00          0.00

    LBC High Threshold = 98 %
    Polarization parameters not supported by optics

    Total TX Power = 7.74 dBm

    Total RX Power = -40.00 dBm

    Lane  Laser Bias    TX Power    RX Power    Output Frequency
    -----
    1      67.2 %    1.85 dBm   -40.00 dBm  231.39 THz
    2      67.9 %    1.55 dBm   -40.00 dBm  230.59 THz
    3      67.5 %    1.58 dBm   -40.00 dBm  229.79 THz
    4      66.8 %    1.89 dBm   -40.00 dBm  230.25 THz
  
```



## Transceiver Vendor Details

```

Form Factor           : QSFP28
Name                  : CISCO-FINISAR
Part Number           : 10-3204-01
Rev Number            : B
Serial Number         : FNS20510YUB
PID                   : ONS-QSFP28-LR4
VID                   : V01
Date Code (yy/mm/dd) : 16/12/15
Fiber Connector Type : LC
Otn Application Code : 4I1-9D1F
Sonet Application Code: Not Set
Ethernet Compliance Code: 100GBASE-LR4

```

Transceiver Temperature : 27 Celsius

```

AINS Soak             : Pending
AINS Timer          : 0h, 2m
AINS remaining time : 120 seconds

```

To override the default AINS settings on a specific controller, use the following commands:

**automatic-in-service controller optics** *R/S/I/P* **hours** *hours* **minutes** *minutes*



---

**Note** This configuration does not persist after an RP reload operation.

---

The following is a sample in which the optics controller on the OTN-XP card is configured with a soak time period of 45 minutes.

```

RP/0/RP0/CPU0:ios#automatic-in-service controller optics 0/1/0/0 hours 0 minutes 45
Tue Apr 28 11:55:15.666 UTC
RP/0/RP0/CPU0:ios#show controllers optics 0/1/0/0
Tue Apr 28 11:55:30.323 UTC

```

Controller State: Down

Transport Admin State: Automatic In Service

Laser State: On

LED State: Red

## Optics Status

```

Optics Type: 100G QSFP28 LR4

```

```

Alarm Status:
-----

```

```

Detected Alarms: None

```

```

LOS/LOL/Fault Status:

```

```

Alarm Statistics:
-----

```

```

HIGH-RX-PWR = 0           LOW-RX-PWR = 0
HIGH-TX-PWR = 0           LOW-TX-PWR = 0
HIGH-LBC = 0              HIGH-DGD = 0
OOR-CD = 0                 OSNR = 0
WVL-OOL = 0                MEA = 0
IMPROPER-REM = 0
TX-POWER-PROV-MISMATCH = 0

```

Performance Monitoring: Enable

THRESHOLD VALUES

-----

Parameter	High Alarm	Low Alarm	High Warning	Low Warning
Rx Power Threshold(dBm)	4.9	-12.0	0.0	0.0
Tx Power Threshold(dBm)	3.5	-10.1	0.0	0.0
LBC Threshold(mA)	N/A	N/A	0.00	0.00

```

LBC High Threshold = 98 %
Polarization parameters not supported by optics

```

Total TX Power = 7.74 dBm

Total RX Power = -40.00 dBm

Lane	Laser Bias	TX Power	RX Power	Output Frequency
1	67.2 %	1.85 dBm	-40.00 dBm	231.39 THz
2	67.9 %	1.55 dBm	-40.00 dBm	230.59 THz
3	67.5 %	1.58 dBm	-40.00 dBm	229.79 THz
4	66.8 %	1.89 dBm	-40.00 dBm	230.25 THz

Transceiver Vendor Details

```

Form Factor           : QSFP28
Name                  : CISCO-FINISAR
Part Number           : 10-3204-01
Rev Number            : B
Serial Number         : FNS20510YUB
PID                   : ONS-QSFP28-LR4
VID                   : V01
Date Code (yy/mm/dd) : 16/12/15
Fiber Connector Type : LC
Otn Application Code  : 4I1-9D1F
Sonet Application Code : Not Set
Ethernet Compliance Code : 100GBASE-LR4

```

Transceiver Temperature : 27 Celsius

```

AINS Soak             : Pending
AINS Timer            : 0h, 45m
AINS remaining time   : 2700 seconds

```

## FEC

Forward error correction (FEC) is a feature that is used for controlling errors during data transmission. This feature works by adding data redundancy to the transmitted message using an algorithm. This redundancy

allows the receiver to detect and correct a limited number of errors occurring anywhere in the message, instead of having to ask the transmitter to resend the message.

## FEC States for Ethernet Controller

The following table lists the FEC states for the Ethernet controller.

State	Description
None	FEC is not enabled on the Ethernet controller.
Standard	Standard (Reed-Solomon) FEC is enabled on the Ethernet controller.

FEC configuration is automatically enabled for only the pluggables that support Auto-FEC. If you manually configure FEC, the manual configuration overrides the Auto-FEC.

The supported pluggables for Auto-FEC are:

- QSFP-100G-SR4-S
- QSFP-100G-CWDM4-S
- QSFP-100G-SM-SR
- QSFP-100G-AOC-1M
- QSFP-100G-AOC-3M
- QSFP-100G-AOC-10M
- QDD-400-AOC15M
- QDD-400G-FR4-S
- QSFP-100G-ER4L
- QDD-400G-DR4-S
- QDD-400G-LR8-S

The LR4 pluggable is a 1310nm long range band pluggable that does not require you to enable FEC.

The software automatically enables FEC mode on the pluggables installed in the Cisco NCS 1004. When you upgrade the software of an NCS 1004 with pluggables in the FEC disabled mode, traffic is affected.

The following sample shows the running FEC configuration on the LR4 pluggable:

```
RP/0/RP0/CPU0:ios#show controller HundredGigEctr1r 0/0/0/4
Thu Aug  8 15:41:20.857 IST
Operational data for interface HundredGigEctr1r0/0/0/4:

State:
  Administrative state: enabled
  Operational state: Up
  LED state: Green On
  Maintenance: Disabled
  AINS Soak: None
  Total Duration: 0 hour(s) 0 minute(s)
```

```

    Remaining Duration: 0 hour(s) 0 minute(s) 0 second(s)
    Laser Squelch: Enabled

```

```

Phy:
    Media type: Not known

```

```

Autonegotiation disabled.

```

```

Operational values:
    Speed: 100Gbps
    Duplex: Full Duplex
    Flowcontrol: None
    Loopback: None (or external)
    BER monitoring:
        Not supported
    Holdoff Time: 0ms

```

The following sample shows the running FEC configuration on the non LR4 pluggable:

```

RP/0/RP0/CPU0:ios#show controller HundredGigEctrlr 0/0/0/2
Thu Aug  8 15:41:56.457 IST
Operational data for interface HundredGigEctrlr0/0/0/2:

```

```

State:
    Administrative state: enabled
    Operational state: Up
    LED state: Green On
    Maintenance: Disabled
    AINS Soak: None
    Total Duration: 0 hour(s) 0 minute(s)
    Remaining Duration: 0 hour(s) 0 minute(s) 0 second(s)
    Laser Squelch: Disabled

```

```

Phy:
    Media type: Not known
    Statistics:
        FEC:
            Corrected Codeword Count: 0
            Uncorrected Codeword Count: 66

```

```

Autonegotiation disabled.

```

```

Operational values:
    Speed: 100Gbps
    Duplex: Full Duplex
    Flowcontrol: None
    Loopback: None (or external)
    BER monitoring:
        Not supported
    Forward error correction: Standard (Reed-Solomon)
    Holdoff Time: 0ms

```

## Configuring FEC on the Ethernet Controller



---

**Note** The FEC configuration is not required for the supported pluggables. The configuration is required only in the case of non-Cisco qualified non-LR4 pluggables.

---

To configure FEC on the Ethernet controller, use the following command:

```
configure
controller HundredGigECtrlr R/S/I/P fec { none | standard }
commit
```

The following sample shows how to configure FEC on the Ethernet controller:

```
RP/0/RP0/CPU0:ios#configure
RP/0/RP0/CPU0:ios(config)#controller HundredGigECtrlr 0/1/0/10 fec standard
RP/0/RP0/CPU0:ios(config)#commit
```

The following sample shows the running FEC configuration on the Ethernet controller:

```
RP/0/RP0/CPU0:BH-SIT2#show controller HundredGigECtrlr 0/1/0/10
Tue Jul 16 15:30:30.165 IST
Operational data for interface HundredGigECtrlr0/1/0/10:

State:
  Administrative state: enabled
  Operational state: Down (Reason: State undefined)
  LED state: Red On
  Maintenance: Disabled
  AINS Soak: None
    Total Duration: 0 hour(s) 0 minute(s)
    Remaining Duration: 0 hour(s) 0 minute(s) 0 second(s)
  Laser Squelch: Disabled

Phy:
  Media type: Not known
  Alarms:
    Current:
      Loss of Frequency Sync Data
  Statistics:
    FEC:
      Corrected Codeword Count: 0
      Uncorrected Codeword Count: 0

Autonegotiation disabled.

Operational values:
  Speed: 100Gbps
  Duplex: Full Duplex
  Flowcontrol: None
  Loopback: None (or external)
  BER monitoring:
    Not supported
  Forward error correction: Standard (Reed-Solomon)
  Holdoff Time: 0ms
```

## FEC States for CoherentDSP Controller

The following table lists the FEC states for the coherentDSP controllers.

**Table 16: FEC State for CoherentDSP Controllers**

State	Description
EnhancedSD15	FEC Soft-Decision 15.

State	Description
EnhancedSD27	FEC Soft-Decision 27. Default.

## Q-Margin Support

Q-margin is an important optical parameter that characterizes the health of an optical link. The Q-margin value is calculated based on the average bit error rate (BER) in the optical link.

*Table 17: Feature History*

Feature Name	Release Information	Description
Enhanced Q-Margin Support	Cisco IOS XR Release 7.3.1	<p>Enhanced Q-Margin is supported for Forward error correction (FEC) and performance monitoring on CoherentDSP Controllers for 1.2T and 1.2TL cards. This enhanced Q-margin value is calculated based on the maximum number of errors for each frame. An attribute that is called <b>instantaneous Q-margin</b> is displayed in the output of the <b>show controllers coherentDSP</b> command. The lower the delta value between the instantaneous Q-margin value with the Q-margin value, the better the FEC performance of the NCS 1004 system. The instantaneous Q-margin values thus help you to optimize the system with continuous error correction in subsea transport networks.</p> <p>Command modified:</p> <ul style="list-style-type: none"> <li>• <b>show controllers coherentDSP</b></li> </ul>

### Enhanced Q-Margin Support

From Release 7.3.1 onwards, enhanced Q-Margin is supported for Forward error correction (FEC) and performance monitoring on CoherentDSP controllers for 1.2T and 1.2TL cards. Enhanced Q-margin provides a better error free signal in the optical link. The enhanced Q-margin value is calculated based on the maximum number of errors per frame. An attribute that is called instantaneous Q-margin is displayed in the output of the **show controllers coherentDSP** command. The lower the delta value between the instantaneous Q-margin value with the Q-margin value, the better the FEC performance of the NCS 1004 system.

To view Q-margin and enhanced Q-margin values for FEC on CoherentDSP controllers, see [Verifying FEC on CoherentDSP Controllers, on page 77](#).

To view Q-margin and enhanced Q-margin values for performance monitoring on CoherentDSP controllers, see [Configuring PM Parameters, on page 151](#).

## Configuring FEC on CoherentDSP Controllers

To configure FEC on the CoherentDSP controller, use the following command:

```
configure
controller coherentDSP R/S/I/P
fec {EnhancedSD15 | EnhancedSD27}
commit
```

The following sample shows how to configure FEC on the CoherentDSP controller:

```
RP/0/RP0/CPU0:ios#configure
RP/0/RP0/CPU0:ios(config)#controller coherentDSP 0/0/0/0
RP/0/RP0/CPU0:ios(config-CoDSP)#fec EnhancedSD15
Tue Feb 25 11:25:52.670 UTC
WARNING! Changing FEC mode can impact traffic
RP/0/RP0/CPU0:ios(config-CoDSP)#commit
```

## Verifying FEC on CoherentDSP Controllers

The following sample shows the FEC configuration on the CoherentDSP controller:

```
RP/0/RP0/CPU0:ios#show controllers coherentDSP 0/0/0/0

Tue Feb 25 11:26:08.235 UTC

Port                : CoherentDSP 0/0/0/0
Controller State    : Up
Inherited Secondary State : Normal
Configured Secondary State : Normal
Derived State       : In Service
Loopback mode       : None
BER Thresholds      : SF = 1.0E-5  SD = 1.0E-7
Performance Monitoring : Enable
Bandwidth           : 50.0Gb/s
Alarm Information:
LOS = 1 LOF = 0 LOM = 0
OOF = 0 OOM = 0 AIS = 0
IAE = 0 BIAE = 0      SF_BER = 0
SD_BER = 0      BDI = 0 TIM = 0
FECMISMATCH = 0 FEC-UNC = 0
Detected Alarms     : None
Bit Error Rate Information
PREFEC BER          : 0.00E+00
POSTFEC BER         : 0.00E+00
Q-Factor            : 0.00 dB
Q-Margin            : -5.00dB
Instantaneous Q_margin : 0 dB

TTI :
Remote IP addr      : 0.0.0.0
FEC mode            : Soft-Decision 15
```

```
AINS Soak : None
AINS Timer : 0h, 0m
AINS remaining time : 0 seconds
```

## Configuring FEC on OTN-XP Card

FEC is supported on the CoherentDSP controllers for the OTN-XP card and O-FEC is the default FEC option configured on the card.

From Release 7.3.1 onwards, CFP2-DCO trunk is configured with 0-FEC.



---

**Note** The options enhanced SD15 and SD17 are not supported on the OTN-XP card.

---



---

**Note** CFEC is not supported on CFP2-DCO.

---

To configure FEC on the CoherentDSP controller for the OTN-XP card, use the following command:

```
configure
controller coherentDSP R/S/I/P
fec OFEC
commit
```

The following sample shows how to configure O-FEC option on the CoherentDSP controller for the OTN-XP card:

```
RP/0/RP0/CPU0:ios#configure
RP/0/RP0/CPU0:ios(config)#controller coherentDSP 0/0/0/0
RP/0/RP0/CPU0:ios(config-CoDSP)#fec OFEC
Tue Feb 25 11:25:52.670 UTC
WARNING! Changing FEC mode can impact traffic
RP/0/RP0/CPU0:ios(config-CoDSP)#commit
```

## Verifying FEC on OTN-XP Card

The following sample shows the FEC configuration on the CoherentDSP controller for the OTN-XP card:

```
RP/0/RP0/CPU0:ios#show controllers coherentDSP 0/0/0/0

Tue Feb 25 11:26:08.235 UTC

Port : CoherentDSP 0/0/0/0
Controller State : Up
Inherited Secondary State : Normal
Configured Secondary State : Normal
Derived State : In Service
Loopback mode : None
BER Thresholds : SF = 1.0E-5 SD = 1.0E-7
Performance Monitoring : Enable
Bandwidth : 50.0Gb/s
```



```

Alarm Information:
LOS = 1 LOF = 0 LOM = 0
OOF = 0 OOM = 0 AIS = 0
IAE = 0 BIAE = 0          SF_BER = 0
SD_BER = 0          BDI = 0 TIM = 0
FECMISMATCH = 0 FEC-UNC = 0
Detected Alarms                               : None
Bit Error Rate Information
  PREFEC BER                                   : 0.00E+00
  POSTFEC BER                                  : 0.00E+00
  Q-Factor                                     : 0.00 dB
  Q-Margin                                     : -5.00dB
Instantaneous Q_margin                       : 0 dB

TTI :
      Remote IP addr                           : 0.0.0.0
FEC mode                                       : O-FEC

AINS Soak                                     : None
AINS Timer                                     : 0h, 0m
AINS remaining time                           : 0 seconds

```

## Laser Squelching

You can enable laser squelching on Ethernet controllers. When laser squelching is enabled, the laser is shut down in the event of trunk faults (LOS, LOF), and a SQUELCHED alarm is raised on the mapped client port.

To configure laser squelching on the Ethernet controllers, use the following commands:

### configure

**controller HundredGigECtrlr** *Rack/Slot/Instance/Port*

### laser-squelch

### commit

The following is a sample where laser squelching is enabled on the Ethernet controller.

```

RP/0/RP0/CPU0:ios#configure
RP/0/RP0/CPU0:ios(config)#controller HundredGigECtrlr 0/1/0/10
RP/0/RP0/CPU0:ios(config-eth-ctrlr)#laser-squelch
RP/0/RP0/CPU0:ios(config-eth-ctrlr)#commit

```

The following is a sample to view the laser squelch status on the controller.

```

RP/0/RP0/CPU0:ios#show controller HundredGigECtrlr 0/1/0/10
Fri Feb 22 15:18:47.011 UTC
Operational data for interface HundredGigECtrlr0/1/0/10:

State:
  Administrative state: enabled
  Operational state: Up
  LED state: Green On
  Maintenance: Disabled
  AINS Soak: None
    Total Duration: 0 hour(s) 0 minute(s)
    Remaining Duration: 0 hour(s) 0 minute(s) 0 second(s)
Laser Squelch: Enabled

```

```
Phy:
  Media type: Not known
  Statistics:
    FEC:
      Corrected Codeword Count: 0
      Uncorrected Codeword Count: 0

Autonegotiation disabled.

Operational values:
  Speed: 100Gbps
  Duplex: Full Duplex
  Flowcontrol: None
  Loopback: None (or external)
  BER monitoring:
    Not supported
  Forward error correction: Standard (Reed-Solomon)
  Holdoff Time: 0ms
```

## Configuring Laser Squelching on OTN-XP Card

From R7.2.1 onwards, laser squelching is supported on 10GE controllers for the OTN-XP card.

From R7.3.1 onwards, laser squelching is supported on 100GE or 400GE controllers for the OTN-XP card.

### Configuring Laser Squelching on 10GE Controllers

To configure laser squelching on the 10GE controllers for the OTN-XP card, use the following commands:

**configure**

**controller tenGigECtrlr** *Rack/Slot/Instance/Port/Lanenumbr*

**laser-squelch**

**commit**

The range of *Lanenumbr* is from 1 to 4.

The following is a sample where laser squelching is enabled on the 10GE controller for the OTN-XP card.

```
RP/0/RP0/CPU0:ios#configure
RP/0/RP0/CPU0:ios(config)#controller tenGigECtrlr 0/0/0/4/1
RP/0/RP0/CPU0:ios(config-eth-ctrlr)#laser-squelch
RP/0/RP0/CPU0:ios(config-eth-ctrlr)#commit
```

The following is a sample to view the laser squelch status on the 10GE controller.

```
P/0/RP0/CPU0:ios#show controllers tenGigECtrlr 0/0/0/4/1
Wed May 6 06:28:29.603 UTC
Operational data for interface TenGigECtrlr0/0/0/4/1:

State:
Administrative state: enabled
Operational state: Up
LED state: Green On
Maintenance: Disabled
AINS Soak: None
Total Duration: 0 hour(s) 0 minute(s)
Remaining Duration: 0 hour(s) 0 minute(s) 0 second(s)
```

**Laser Squelch: Enabled**

```
Phy:
Media type: Not known

Autonegotiation disabled.

Operational values:
Speed: 10Gbps
Duplex: Full Duplex
Flowcontrol: None
Loopback: None (or external)
Inter-packet gap: standard (12)
BER monitoring:
Not supported
Holdoff Time: 0ms
```

**Configuring Laser Squelching on 100GE Controllers**

To configure laser squelching on the 100GE controllers for the OTN-XP card, use the following commands:

```
configure
```

```
controller HundredGigECtrlr Rack/Slot/Instance/Port
```

```
laser-squelch
```

```
commit
```

The following is a sample where laser squelching is enabled on the 100GE controller for the OTN-XP card.

```
RP/0/RP0/CPU0:ios#configure
RP/0/RP0/CPU0:ios(config)#controller HundredGigECtrlr 0/0/0/1
RP/0/RP0/CPU0:ios(config-eth-ctrlr)#laser-squelch
RP/0/RP0/CPU0:ios(config-eth-ctrlr)#commit
```

The following is a sample to view the laser squelch status on the 100GE controller.

```
RP/0/RP0/CPU0:ios#show controller hundredGigECtrlr 0/0/0/1
Fri Jul 23 16:07:11.541 UTC
Operational data for interface HundredGigECtrlr0/0/0/1:
```

```
State:
  Administrative state: enabled
  Operational state: Up
  LED state: Green On
  Maintenance: Disabled
  AINS Soak: None
    Total Duration: 0 hour(s) 0 minute(s)
    Remaining Duration: 0 hour(s) 0 minute(s) 0 second(s)
Laser Squelch: Enabled
```

```
Phy:
  Media type: Not known
Statistics:
FEC:
Corrected Codeword Count: 134967789
Uncorrected Codeword Count: 0
Autonegotiation disabled.
```

```
Operational values:
  Speed: 100Gbps
```

```

Duplex: Full Duplex
Flowcontrol: None
Loopback: None (or external)
BER monitoring:
    Not supported
Forward error correction: Standard (Reed-Solomon)
Holdoff Time: 0ms

```

### Configuring Laser Squelching on 400GE Controllers

To configure laser squelching on the 400GE controllers for the OTN-XP card, use the following commands:

**configure**

**controller fourHundredGigECtrlr** *Rack/Slot/Instance/Port*

**laser-squelch**

**commit**

The following is a sample where laser squelching is enabled on the 400GE controller for the OTN-XP card.

```

RP/0/RP0/CPU0:ios#configure
RP/0/RP0/CPU0:ios(config)#controller fourHundredGigECtrlr 0/0/0/8
RP/0/RP0/CPU0:ios(config-eth-ctrlr)#laser-squelch
RP/0/RP0/CPU0:ios(config-eth-ctrlr)#commit

```

The following is a sample to view the laser squelch status on the 400GE controller.

```

RP/0/RP0/CPU0:ios#show controller fourhundredGigECtrlr 0/0/0/8
Fri Jul 23 16:07:11.541 UTC
Operational data for interface fourHundredGigECtrlr0/0/0/8:

```

```

State:
  Administrative state: enabled
  Operational state: Up
  LED state: Green On
  Maintenance: Disabled
  AINS Soak: None
    Total Duration: 0 hour(s) 0 minute(s)
    Remaining Duration: 0 hour(s) 0 minute(s) 0 second(s)
Laser Squelch: Enabled

```

```

Phy:
  Media type: Not known

```

```

Statistics:
FEC:
Corrected Codeword Count: 134967789
Uncorrected Codeword Count: 0
Autonegotiation disabled.

```

```

Operational values:
  Speed: 400Gbps
  Duplex: Full Duplex
  Flowcontrol: None
  Loopback: None (or external)
  BER monitoring:
    Not supported
  Forward error correction: Standard (Reed-Solomon)
  Holdoff Time: 0ms

```

# Idle Insertion

When a fault occurs on the trunk port, you can hold the propagation of local faults using the idle insertion feature. This feature is enabled on the ethernet controller by configuring the hold-off timer.

When the fault occurs on the trunk, idles are inserted in the traffic stream from the trunk port to the client port for the duration of the configured holdoff-time. If the trunk port remains faulty beyond the configured holdoff-time, a local fault is transmitted towards the client device. If the trunk recovers from the fault before the holdoff-time expires, traffic resumes.

This feature can be used on customer deployments to prevent reset of client ports during a PSM switchover.

You can enable the idle insertion feature by using the following commands:

## configure

**controller HundredGigECtrlr** *Rack/Slot/Instance/Port*

**holdoff-time trunk-fault** *time-value*

The range of *timevalue* is from 0 ms to 3000 ms.

The following is a sample for enabling the hold off -timer in 100GE controllers:

```
RP/0/RP0/CPU0:ios#configure
RP/0/RP0/CPU0:ios(config)#controller HundredGigECtrlr 0/1/0/10
RP/0/RP0/CPU0:ios (config-eth-ctrlr)#holdoff-time trunk-fault 3000
RP/0/RP0/CPU0:ios(config-eth-ctrlr)#commit
```

To view the hold-off time that is configured on 100GE controller, use the following command:

**show controllers hundredGigECtrlr** *Rack/Slot/Instance/Port*

## Example

```
RP/0/RP0/CPU0:ios#show controllers HundredGigECtrlr 0/1/0/10
Fri Feb 22 18:58:06.888 UTC
Operational data for interface HundredGigECtrlr0/1/0/10:
```

### State:

```
Administrative state: enabled
Operational state: Up
LED state: Green On
Maintenance: Disabled
AINS Soak: None
  Total Duration: 0 hour(s) 0 minute(s)
  Remaining Duration: 0 hour(s) 0 minute(s) 0 second(s)
Laser Squelch: Disabled
```

### Phy:

```
Media type: Not known
Statistics:
  FEC:
    Corrected Codeword Count: 0
    Uncorrected Codeword Count: 0
```

Autonegotiation disabled.

### Operational values:

```
Speed: 100Gbps
Duplex: Full Duplex
Flowcontrol: None
Loopback: None (or external)
```

```

BER monitoring:
  Not supported
Forward error correction: Standard (Reed-Solomon)
Holdoff Time: 3000ms

```

## Enabling Idle Insertion on OTN-XP Card

From R7.2.1 onwards, you can enable the idle insertion feature on the 10GE controller for OTN-XP card.

From R7.3.1 onwards, you can enable the idle insertion feature on 100GE or 400GE controllers for the OTN-XP card.

To enable idle insertion on the 10GE controller, enter the following commands:

**configure**

**controller tenGigECtrlr** *Rack/Slot/Instance/Port/Lanenumbr*

**holdoff-time trunk-fault** *time-value*

**commit**

The range of *Lanenumbr* is from 1 to 4 and the range of holdoff-time trunk-fault *time-value* is from 0 to 3000 ms.

The following is a sample for enabling the idle insertion feature in 10GE controllers:

```

RP/0/RP0/CPU0:ios#configure
RP/0/RP0/CPU0:ios(config)#controller tenGigECtrlr 0/0/0/4/1
RP/0/RP0/CPU0:ios(config-eth-ctrlr)#holdoff-time trunk-fault 2000
RP/0/RP0/CPU0:ios(config-eth-ctrlr)#commit

```

To view the hold-off time that is configured on 10GE controllers, use the following command:

**show controllers tenGigECtrlr** *Rack/Slot/Instance/Port/Lanenumbr*

### Example

```

RP/0/RP0/CPU0:ios#show controllers TenGigECtrlr 0/0/0/4/1
Thu Mar 26 12:46:16.543 UTC
Operational data for interface TenGigECtrlr0/0/0/4/1:

State:
  Administrative state: enabled
  Operational state: Up
  LED state: Green On
  Maintenance: Disabled
  AINS Soak: None
    Total Duration: 0 hour(s) 0 minute(s)
    Remaining Duration: 0 hour(s) 0 minute(s) 0 second(s)
  Laser Squelch: Disabled

Phy:
  Media type: Not known

Autonegotiation disabled.

Operational values:
  Speed: 10Gbps
  Duplex: Full Duplex
  Flowcontrol: None
  Loopback: None (or external)
  Inter-packet gap: standard (12)

```

```

BER monitoring:
  Not supported
Holdoff Time: 2000ms

```

### Configuring Idle Insertion on 100GE Controllers

To configure idle insertion on the 100GE controllers for the OTN-XP card, use the following commands:

**configure**

**controller HundredGigECtrlr** *Rack/Slot/Instance/Port*

**holdoff-time trunk-fault** *time-value*

**commit**

The range of *timevalue* is from 0 ms to 3000 ms.

The following is a sample where idle insertion is enabled on the 100GE controller for the OTN-XP card.

```

RP/0/RP0/CPU0:ios#configure
RP/0/RP0/CPU0:ios(config)#controller HundredGigECtrlr 0/0/0/1
RP/0/RP0/CPU0:ios(config-eth-ctrlr)#holdoff-time trunk-fault 3000
RP/0/RP0/CPU0:ios(config-eth-ctrlr)#commit

```

The following is a sample to view the idle insertion status on the 100GE controller.

```

RP/0/RP0/CPU0:ios#show controller hundredGigECtrlr 0/0/0/1
Fri Jul 23 16:07:11.541 UTC
Operational data for interface HundredGigECtrlr0/0/0/1:

```

State:

```

Administrative state: enabled
Operational state: Up
LED state: Green On
Maintenance: Disabled
AINS Soak: None
  Total Duration: 0 hour(s) 0 minute(s)
  Remaining Duration: 0 hour(s) 0 minute(s) 0 second(s)
Laser Squelch: Enabled

```

Phy:

```
Media type: Not known
```

Statistics:

FEC:

```
Corrected Codeword Count: 134967789
```

```
Uncorrected Codeword Count: 0
```

Autonegotiation disabled.

Operational values:

```
Speed: 100Gbps
```

```
Duplex: Full Duplex
```

```
Flowcontrol: None
```

```
Loopback: None (or external)
```

```
BER monitoring:
```

```
  Not supported
```

```
  Forward error correction: Standard (Reed-Solomon)
```

```
Holdoff Time: 3000ms
```

### Configuring Idle Insertion on 400GE Controllers

To configure idle insertion on the 400GE controllers for the OTN-XP card, use the following commands:

**configure**

**controller fourHundredGigECtrlr** *Rack/Slot/Instance/Port*

**holdoff-time trunk-fault** *time-value*

**commit**

The following is a sample where idle insertion is enabled on the 400GE controller for the OTN-XP card.

```
RP/0/RP0/CPU0:ios#configure
RP/0/RP0/CPU0:ios(config)#controller fourHundredGigECtrlr 0/0/0/10
RP/0/RP0/CPU0:ios(config-eth-ctrlr)#holdoff-time trunk-fault 2000
RP/0/RP0/CPU0:ios(config-eth-ctrlr)#commit
```

The following is a sample to view the idle insertion status on the 400GE controller.

```
RP/0/RP0/CPU0:ios#show controller fourhundredGigECtrlr 0/0/0/10
Fri Jul 23 16:07:11.541 UTC
Operational data for interface fourHundredGigECtrlr0/0/0/10:
```

State:

```
Administrative state: enabled
Operational state: Up
LED state: Green On
Maintenance: Disabled
AINS Soak: None
  Total Duration: 0 hour(s) 0 minute(s)
  Remaining Duration: 0 hour(s) 0 minute(s) 0 second(s)
Laser Squelch: Enabled
```

Phy:

```
Media type: Not known
```

Statistics:

```
FEC:
Corrected Codeword Count: 134967789
Uncorrected Codeword Count: 0
```

Autonegotiation disabled.

Operational values:

```
Speed: 400Gbps
Duplex: Full Duplex
Flowcontrol: None
Loopback: None (or external)
BER monitoring:
  Not supported
  Forward error correction: Standard (Reed-Solomon)
Holdoff Time: 2000ms
```

## LLDP Drop

Link Layer Discovery Protocol (LLDP) Snooping is enabled by default on all ethernet controllers.

To verify the LLDP neighbors, use the following commands:



```
RP/0/RP0/CPU0:ios#show lldp neighbors detail
Tue Mar 12 11:49:20.819 IST
Capability codes:
    (R) Router, (B) Bridge, (T) Telephone, (C) DOCSIS Cable Device
    (W) WLAN Access Point, (P) Repeater, (S) Station, (O) Other
```

```
-----
Local Interface: HundredGigECtrlr0/1/0/7
Chassis id: 008a.96cd.34e1
Port id: Hu0/0/0/4
Port Description - not advertised
System Name: ncs5500_node
```

```
System Description:
  6.1.4, NCS-5500
```

```
Time remaining: 116 seconds
Hold Time: 120 seconds
System Capabilities: R
Enabled Capabilities: R
Management Addresses - not advertised
Peer MAC Address: 00:8a:96:cd:34:10
```

```
-----
Local Interface: HundredGigECtrlr0/1/0/13
Chassis id: 008a.96cd.34e1
Port id: Hu0/0/0/5
Port Description - not advertised
System Name: ncs5500_node
```

```
System Description:
  6.1.4, NCS-5500
```

```
Time remaining: 90 seconds
Hold Time: 120 seconds
System Capabilities: R
Enabled Capabilities: R
Management Addresses - not advertised
Peer MAC Address: 00:8a:96:cd:34:14
```

```
Total entries displayed: 2
```

```
RP/0/RP0/CPU0:ios#show lldp neighbors
Tue Mar 12 16:17:56.713 IST
Capability codes:
    (R) Router, (B) Bridge, (T) Telephone, (C) DOCSIS Cable Device
    (W) WLAN Access Point, (P) Repeater, (S) Station, (O) Other
```

Device ID	Local Intf	Hold-time	Capability	Port ID
ncs5500_node	HundredGigECtrlr0/1/0/7	120	R	Hu0/0/0/4
ncs5500_node	HundredGigECtrlr0/1/0/13	120	R	Hu0/0/0/5

```
Total entries displayed: 2
```

When you enable LLDP drop on the client controller ports of the muxponder or muxponder slice, the LLDP frames drop on the ports without forwarding.



---

**Note** LLDP on 400GE is not supported on the OTN-XP card.

---

## Configuring LLDP Drop

You can configure the LLDP drop for a muxponder or muxponder slice. By default, the LLDP drop status is set to False. On enabling the LLDP Drop, the status is set to True.

To configure LLDP drop on a muxponder use the following command:

**configure**

**hw-module location *location* mxponder drop-lldp**



---

**Note** Use the **no** form of the command to disable LLDP drop.

---

**commit**

### Limitation

- When you disable LLDP globally, the LLDP gets disabled on all the interfaces.



---

**Note** By default, LLDP is enabled for NCS 1004. But when you enable and disable LLDP in the global configuration mode, LLDP gets disabled on all the interfaces.

**Workaround:** You must enable LLDP globally or reload the Router.

---

```
RP/0/RP0/CPU0:ios#configure
RP/0/RP0/CPU0:ios#hw-module location 0/1 mxponder drop-lldp
RP/0/RP0/CPU0:ios#commit
```

**configure**

**hw-module location *location* mxponder-slice *slice-number* drop-lldp**



---

**Note** Use the **no** form of the command to disable LLDP drop.

---

To configure LLDP drop on a muxponder slice, use the following command:

**commit**

The following is a sample in which slice 0 client ports are enabled with LLDP drop.

```
RP/0/RP0/CPU0:ios#configure
RP/0/RP0/CPU0:ios(config)#hw-module location 0/1 mxponder-slice 0 drop-lldp
RP/0/RP0/CPU0:ios(config)#commit
```

## Verifying the Status of LLDP Drop

To verify the LLDP drop enabled status, use the following command.

```
RP/0/RP0/CPU0:ios#show hw-module location all mxponder
Fri Feb 22 13:22:19.281 UTC
```

```
Location:                0/0
```

Client Bitrate: NONE  
 Trunk Bitrate: NONE  
 Status: Not Provisioned

Location: 0/1  
 Slice ID: 0  
 Client Bitrate: 100GE  
 Trunk Bitrate: 500G  
 Status: Provisioned

**LLDP Drop Enabled: FALSE**

Client Port	Mapper/Trunk Port Traffic Split Percentage	CoherentDSP0/1/0/0
-------------	---	--------------------

HundredGigECtrlr0/1/0/2	ODU40/1/0/0/0	100
HundredGigECtrlr0/1/0/3	ODU40/1/0/0/1	100
HundredGigECtrlr0/1/0/4	ODU40/1/0/0/2	100
HundredGigECtrlr0/1/0/5	ODU40/1/0/0/3	100
HundredGigECtrlr0/1/0/6	ODU40/1/0/0/4	100

Location: 0/1  
 Slice ID: 1  
 Client Bitrate: 100GE  
 Trunk Bitrate: 500G  
 Status: Provisioned

**LLDP Drop Enabled: FALSE**

Client Port	Mapper/Trunk Port Traffic Split Percentage	CoherentDSP0/1/0/1
-------------	---	--------------------

HundredGigECtrlr0/1/0/8	ODU40/1/0/1/0	100
HundredGigECtrlr0/1/0/9	ODU40/1/0/1/1	100
HundredGigECtrlr0/1/0/10	ODU40/1/0/1/2	100
HundredGigECtrlr0/1/0/11	ODU40/1/0/1/3	100
HundredGigECtrlr0/1/0/12	ODU40/1/0/1/4	100

Location: 0/2  
 Slice ID: 0  
 Client Bitrate: 100GE  
 Trunk Bitrate: 500G  
 Status: Provisioned

**LLDP Drop Enabled: FALSE**

Client Port	Mapper/Trunk Port Traffic Split Percentage	CoherentDSP0/2/0/0
-------------	---	--------------------

HundredGigECtrlr0/2/0/2	ODU40/2/0/0/0	100
HundredGigECtrlr0/2/0/3	ODU40/2/0/0/1	100
HundredGigECtrlr0/2/0/4	ODU40/2/0/0/2	100
HundredGigECtrlr0/2/0/5	ODU40/2/0/0/3	100
HundredGigECtrlr0/2/0/6	ODU40/2/0/0/4	100

Location: 0/2  
 Slice ID: 1  
 Client Bitrate: 100GE  
 Trunk Bitrate: 500G  
 Status: Provisioned

**LLDP Drop Enabled: FALSE**

Client Port	Mapper/Trunk Port Traffic Split Percentage	CoherentDSP0/2/0/1
-------------	---	--------------------

HundredGigECtrlr0/2/0/8	ODU40/2/0/1/0	100
HundredGigECtrlr0/2/0/9	ODU40/2/0/1/1	100

HundredGigECtrlr0/2/0/10	ODU40/2/0/1/2	100
HundredGigECtrlr0/2/0/11	ODU40/2/0/1/3	100
HundredGigECtrlr0/2/0/12	ODU40/2/0/1/4	100
Location:	0/3	
Slice ID:	0	
Client Bitrate:	100GE	
Trunk Bitrate:	300G	
Status:	Provisioned	
<b>LLDP Drop Enabled:</b>	<b>TRUE</b>	
Client Port	Mapper/Trunk Port	CoherentDSP0/3/0/0
	Traffic Split Percentage	
HundredGigECtrlr0/3/0/2	ODU40/3/0/0/0	100
HundredGigECtrlr0/3/0/3	ODU40/3/0/0/1	100
HundredGigECtrlr0/3/0/4	ODU40/3/0/0/2	100

## Link Layer Discovery Protocol (LLDP) Support on Management Interface

The LLDP support on management interface feature requires a system to form LLDP neighborhood over the system management interface, through which it advertises and learns LLDP neighbor information. This information about neighbors used to learn about the neighbors and in turn the topology of the devices for Operations, Administration, and Maintenance (OAM) purposes.

### Advantages of LLDP

- Provides support on non-Cisco devices.
- Enables neighbor discovery between non-Cisco devices.

### Limitation

- When you disable LLDP globally, the LLDP gets disabled on all the interfaces.



**Note** By default, LLDP is enabled for NCS 1004. But when you enable and disable LLDP in the global configuration mode, LLDP gets disabled on all the interfaces.

**Workaround:** You must enable LLDP globally or reload the Router.

### Cisco Discovery Protocol (CDP) vs LLDP

The CDP is a device discovery protocol that runs over Layer 2. Layer 2 is also known as the data link layer that runs on all Cisco devices, such as routers, bridges, access servers, and switches. This protocol allows the network management applications to automatically discover and learn about other Cisco devices that connect to the network.

The LLDP is also a device discovery protocol that runs over Layer 2. This protocol allows the network management applications to automatically discover and learn about other non-Cisco devices that connect to the network.

### Interoperability between non-Cisco devices using LLDP

LLDP is also a neighbor discovery protocol that is used by network devices to advertise information about themselves to other devices on the network. This protocol runs over the data link layer, which allows two systems running different network layer protocols to learn about each other.

With LLDP, the user can also access the information about a particular physical network connection. If the user uses a non-Cisco monitoring tool (through SNMP), LLDP helps you identify the Object Identifiers (OIDs) that the system supports. The following OIDs are supported:

- 1.0.8802.1.1.2.1.4.1.1.4
- 1.0.8802.1.1.2.1.4.1.1.5
- 1.0.8802.1.1.2.1.4.1.1.6
- 1.0.8802.1.1.2.1.4.1.1.7
- 1.0.8802.1.1.2.1.4.1.1.8
- 1.0.8802.1.1.2.1.4.1.1.9
- 1.0.8802.1.1.2.1.4.1.1.10
- 1.0.8802.1.1.2.1.4.1.1.11
- 1.0.8802.1.1.2.1.4.1.1.12

### Neighbor Discovery

System advertises the LLDP TLV (Type Length Value) details over the management network using which other devices in the management network can learn about this device.

### Configuring LLDP

- LLDP full stack functionality is supported on all three management interfaces supported in NCS 1004.
- You can selectively enable or disable LLDP on any of the management interfaces on demand.
- You can selectively enable or disable LLDP transmit or receive functionality at the management interface level.
- Information gathered using LLDP can be stored in the device Management Information Database (MIB) and queried with the Simple Network Management protocol (SNMP).
- LLDP operational data are available in both Command Line Interface and netconf-yang interface.

### Enabling LLDP Globally

When you enable LLDP globally, all interfaces that support LLDP are automatically enabled for both transmit and receive operations.



---

**Note** You can override this default operation at the interface to disable receive or transmit operations.

---

The following table describes the global LLDP attributes that the user can configure:

Table 18:

Attribute	Default	Range	Description
Holdtime	120	0–65535	Specifies the hold time (in sec). Hold time refers to the time or duration that an LLDP device maintains the neighbor information before discarding.
Reinit	2	2–5	Delay (in sec) for LLDP initialization on any interface
Timer	30	5–65534	Specifies the rate at which LLDP packets are sent (in sec)

The following example shows the commands to configure LLDP globally. The global LLDP configuration enables LLDP on all the three management interfaces.

```
RP/0/RP0/CPU0:regen#configure terminal
RP/0/RP0/CPU0:regen(config)#lldp management enable
RP/0/RP0/CPU0:regen(config)#lldp holdtime 30
RP/0/RP0/CPU0:regen(config)#lldp reinit 2
RP/0/RP0/CPU0:regen(config)#commit
```

### Verification

You can verify the LLDP configuration using the **show running-config lldp** command.

The output of **show running-config lldp** command is as follows:

```
RP/0/RP0/CPU0:regen#show running-config lldp
Tue Dec 10 10:36:11.567 UTC
lldp
timer 30
reinit 2
holdtime 120
management enable
!
```

You can verify the LLDP data using the **show lldp interface** and **show lldp neighbors** commands.

The output of **show lldp interface** command is as follows:

```
RP/0/RP0/CPU0:regen#show lldp interface
Thu Nov 7 08:45:22.934 UTC

MgmtEth0/RP0/CPU0/0:
  Tx: enabled
  Rx: enabled
  Tx state: IDLE
  Rx state: WAIT FOR FRAME

MgmtEth0/RP0/CPU0/1:
  Tx: enabled
  Rx: enabled
```

```
Tx state: IDLE
Rx state: WAIT FOR FRAME
```

The output of **show lldp neighbors** command is as follows:

```
RP/0/RP0/CPU0:M-131#show lldp neighbors
Mon Dec 2 11:01:20.143 CET
Capability codes:
  (R) Router, (B) Bridge, (T) Telephone, (C) DOCSIS Cable Device
  (W) WLAN Access Point, (P) Repeater, (S) Station, (O) Other

Device ID           Local Intf           Hold-time  Capability  Port ID
[DISABLED]         MgmtEth0/RP0/CPU0/0  120       B           gi19
MYS-130            MgmtEth0/RP0/CPU0/1  120       R           MgmtEth0/RP0/CPU0/1
```

where [ DISABLED] shows that the LLDP is disabled on the interface MgmtEth0/RP0/CPU0/0.

### Enabling LLDP per Management Interface

The following example shows the commands to configure LLDP at the management interface level.

```
RP/0/RP0/CPU0:ios(config)#interface mgmtEth 0/RP0/CPU0/X
RP/0/RP0/CPU0:ios(config-if)#lldp enable
RP/0/RP0/CPU0:ios(config-if)#commit
```

### Disabling LLDP Transmit and Receive Operations

The following example shows the commands to disable the LLDP transmit operations at the specified management interface.

```
RP/0/RP0/CPU0:ios(config)#interface mgmtEth 0/RP0/CPU0/X
RP/0/RP0/CPU0:ios(config-if)#lldp transmit disable
RP/0/RP0/CPU0:ios(config-if)#commit
```

The following example shows the commands to disable the LLDP receive operations at the specified management interface.

```
RP/0/RP0/CPU0:ios(config)#interface mgmtEth 0/RP0/CPU0/X
RP/0/RP0/CPU0:ios(config-if)#lldp receive disable
RP/0/RP0/CPU0:ios(config-if)#commit
```

### Debugging LLDP Issues

The following commands are used for debugging issues in the LLDP functionality.

- **show lldp traffic**
- **debug lldp all**
- **debug lldp errors**
- **debug lldp events**
- **debug lldp packets**
- **debug lldp tlvs**
- **debug lldp trace**
- **debug lldp verbose**

# DHCP Client

Table 19: Feature History

Feature Name	Release Information	Feature Description
Dynamic Host Configuration Protocol (DHCP) Client	Cisco IOS XR Release 7.3.2	The DHCP client enables the router interfaces to dynamically acquire the IPv4 or DHCPv4 or DHCPv6 server which is used to forward the response to the correct layer 2 address. The DHCP client ensures that configuration information reaches the correct device.

The Dynamic Host Configuration Protocol (DHCP) client functionality enables the router interfaces to dynamically acquire the IPv4 or DHCPv4 or DHCPv6 server, and forwards the responses back to the correct Layer 2 address so that the correct device gets the correct configuration information.

DHCP has the ability to allocate IP addresses only for a configurable period of time, called the lease period. If the client is required to retain this IP address for a longer period beyond the lease period, the lease period must be renewed before the IP address expires. The client renews the lease based on configuration that was sent from the server. The client unicasts a REQUEST message using the IP address of the server. When a server receives the REQUEST message and responds with an ACK message. The lease period of the client is extended by the lease time configured in the ACK message. DHCP client supports DHCPv6.

## DHCP Client Options

You can configure DHCPv6 client on management Ethernet interfaces. You can configure different DHCPv6 client options to differentiate between clients as required. The different DHCPv6 client options are also configured to differentiate how a DHCPv6 client communicates with a DHCPv6 server. The different DHCPv6 client options that can be configured are:

- **DUID:** If the DUID DHCPv6 client option is configured on an interface, DHCPv6 client communicates with the DHCPv6 server through the link layer address.
- **Rapid Commit:** If the Rapid Commit DHCPv6 client option is configured on an interface, DHCPv6 client can obtain configuration parameters from the DHCPv6 server through a rapid two-step exchange (solicit and reply) instead of the default four-step exchange (solicit, advertise, request, and reply).
- **DHCP Options:** The various other DHCPv6 options that can be configured on a DHCPv6 client are:
  - **Option 15:** Option 15 is also known as the User Class option and it is used by a DHCPv6 client to identify the type or category of users or applications it represents.
  - **Option 16:** Option 16 is also known as the Vendor ID option and it is used by a DHCPv6 a client to identify the vendor that manufactured the hardware on which the client is running.
  - **Option 23:** Option 23 is also known as the Domain name Server (DNS) option provides a list of one or more IPv6 addresses of DNS recursive name servers to which a client's DNS resolver can send DNS queries.



- **Option 24:** Option 24 is also known as the Domain List option and it specifies the domain search list that the client uses to resolve hostnames with the DNS.
- **DHCP Timers:** This option is used to set different timer value for DHCP client configurations. The various DHCP timer options are:
  - **Release-timeout:** It is used to set retransmission timeout value for the initial release message.
  - **Req-max-rt:** It is used to set the maximum retransmission timeout value for the request message.
  - **Req-max-rt:** It is used to set the maximum retransmission timeout value for the request message.
  - **Sol-max-delay:** It is used to set the maximum delay time of the first solicit message.
  - **Sol-max-rt:** It is used to set the maximum solicit retransmission time.
  - **Sol-time-out:** It is used to set the initial timeout value of the solicit message.

## Enabling DHCP Client on Management Ethernet Interface

To enable DHCP client on the management Ethernet interface, use the following command:

```
configure
interface MgmtEth R/S/I/P
ipv6 address dhcp-client-options
duid linked-layer-address
rapid-commit
{option 16 vendor | option 15 ciscoupnp | option 23 | option 24}
timers sol-max-delay value | timers sol-time-out value | timers req-timeout value | timers req-max-rt
value | timers release-timeout value}
ipv6 address dhcp
commit
```

The following sample shows to enable DHCP client on the management Ethernet interface:

```
RP/0/RP0/CPU0:ios#configure
RP/0/RP0/CPU0:ios(config)#interface MgmtEth0/0/CPU0/0
RP/0/RP0/CPU0:ios(config)#ipv6 address dhcp-client-options
RP/0/RP0/CPU0:ios(config-dhcpv6-client)#duid linked-layer-address
RP/0/RP0/CPU0:ios(config-dhcpv6-client)#rapid-commit
RP/0/RP0/CPU0:ios(config-dhcpv6-client)#option 16 vendor
RP/0/RP0/CPU0:ios(config-dhcpv6-client)#option 15 ciscoupnp
RP/0/RP0/CPU0:ios(config-dhcpv6-client)#option 23
RP/0/RP0/CPU0:ios(config-dhcpv6-client)#option 24
RP/0/RP0/CPU0:ios(config-dhcpv6-client)#timers sol-max-delay 1
RP/0/RP0/CPU0:ios(config-dhcpv6-client)#timers sol-time-out 1
RP/0/RP0/CPU0:ios(config-dhcpv6-client)#timers sol-max-rt 120
RP/0/RP0/CPU0:ios(config-dhcpv6-client)#timers req-timeout 1
RP/0/RP0/CPU0:ios(config-dhcpv6-client)#timers req-max-rt 30
RP/0/RP0/CPU0:ios(config-dhcpv6-client)#timers release-timeout 1
RP/0/RP0/CPU0:ios(config-dhcpv6-client)#commit
```

## Verifying DHCP Client on Management Ethernet Interface

To verify DHCP client options on the management Ethernet interface, use the **show dhcp ipv6 client** and **show dhcp ipv6 client detail** commands:

```
RP/0/0/CPU0:ios#show dhcp ipv6 client
Thu Sep 17 10:45:44.493 IST
```

```
Interface name IPv6 Address State Lease Time Rem
-----
MgmtEth0/0/1/0 500:1::1a/128 BOUND 7116
```

```
RP/0/RP0/CPU0:ios#show dhcp ipv6 client detail
Thu Sep 17 10:45:48.880 IST
```

```
-----
Client Interface name : MgmtEth0/0/`/0
Client Interface handle : 0x4040
Client MACAddr : 0219.bc81.e750
Client State : BOUND
Client Link Local Address : fe80::19:bcff:fe81:e750
Client IPv6 Address (Dhcp) : 500:1::1a/128
Lease Remaining (in secs) : 7112
DUID : 000300010219bc81e750
```

```
Client Configuration
Timers
SOL_MAX_DELAY : 1 secs (00:00:01)
SOL_TIMEOUT : 1 secs (00:00:01)
SOL_MAX_RT : 120 secs (00:02:00)
REQ_TIMEOUT : 1 secs (00:00:01)
REQ_MAX_RT : 30 secs (00:00:30)
REL_TIMEOUT : 1 secs (00:00:01)
```

```
Options
RAPID-COMMIT : True
USER-CLASS : ciscoupnp
VENDOR-CLASS : vendor
DNS-SERVERS : True
DOMAIN-LIST : True
```

```
DUID Type : DUID_LL
```

```
Server Information
Server Address : fe80::1a:19ff:fe03:99ca
Preference : 255
DUID : 000300010206826e2e00
Status : SUCCESS
IA-NA
Status : SUCCESS
IAID : 0x40400001
T1 : 3600 secs (01:00:00)
T2 : 5760 secs (01:36:00)
IA-ADDR
IA NA Address : 500:1::1a
Preferred Time : 7200 secs (02:00:00)
Valid Time : 7200 secs (02:00:00)
Flags : 0x0
-----
```

# MAC Address Snooping on Client Ports

MAC address snooping allows you to learn the MAC address of the neighbor, that is connected to the client ports. You can enable ARP snooping on all client ports and learn the MAC address of neighbors through CLI.

This feature overcomes the limitation, where LLDP (Link Layer Discovery protocol) cannot be enabled in some networks.

## Limitations

- When you enable or disable MAC address snooping on any slice, few packets are dropped during configuration.
- Open config interface for enabling or disabling MAC address snooping is not supported.
- SNMP MIB is not supported for the MAC address attribute.



**Note** When you enable MAC address snooping on client ports, it overrides LLDP.

## Configuring MAC Address Snooping on Client Ports

You can configure MAC address or ARP snoop on slice in Muxponder slice mode using the following commands.

### configure

**hw-module location** *location mxponder-slice slice-number*

**client-rate** 100GE

**trunk-rate** 600G { 100G | 150G | 200G | 250G | 300G | 350G | 400G | 450G | 500G | 550G | 600G }

**arp-snoop**

**commit**

### Example

The following is a sample in which, MAC address or ARP snoop is configured on the client ports of slice 0 in Muxponder slice mode.

```
RP/0/RP0/CPU0:ios#configure
Mon Mar 16 19:30:33.933 UTC
RP/0/RP0/CPU0:ios(config)#hw-module location 0/3 mxponder-slice 0
RP/0/RP0/CPU0:ios(config-hwmod-mxp)#client-rate 100GE
RP/0/RP0/CPU0:ios(config-hwmod-mxp)#trunk-rate 600G
RP/0/RP0/CPU0:ios(config-hwmod-mxp)#arp-snoop
RP/0/RP0/CPU0:ios(config-hwmod-mxp)#commit
Mon Mar 16 19:30:52.636 UTC
RP/0/RP0/CPU0:ios(config-hwmod-mxp)#end
```

The following is a sample in which, MAC address or ARP snoop is configured in Muxponder mode.

```
RP/0/RP0/CPU0:ios#configure
Mon Mar 16 19:08:17.154 UTC
RP/0/RP0/CPU0:ios(config)#hw-module location 0/1 mxponder arp-snoop
RP/0/RP0/CPU0:ios(config)#commit
```

The following sample shows the output of **show controllers hundredGigEctr1r** command, before configuring MAC address or ARP snoop on client ports.

```
RP/0/RP0/CPU0:ios#show controllers hundredGigEctr1r 0/1/0/2
Mon Mar 16 19:40:37.434 UTC
Operational data for interface HundredGigEctr1r0/1/0/2:

State:
  Administrative state: enabled
  Operational state: Up
  LED state: Green On
  Maintenance: Disabled
  AINS Soak: None
    Total Duration: 0 hour(s) 0 minute(s)
    Remaining Duration: 0 hour(s) 0 minute(s) 0 second(s)
  Laser Squelch: Disabled

Phy:
  Media type: Not known

Autonegotiation disabled.

Operational values:
  Speed: 100Gbps
  Duplex: Full Duplex
  Flowcontrol: None
  Loopback: None (or external)
  BER monitoring:
    Not supported
  Holdoff Time: 0ms
```

## Viewing Neighbor MAC Address

You can view the neighbor's physical address after enabling MAC address or ARP snoop using the following command. MAC address snoop output is enabled after ARP packets are received on the respective 100G client.

**show controllers hundredGigEctr1r R/S/I/P**

The following sample shows the neighbor's MAC address after configuring MAC address or ARP snoop on client ports.

```
RP/0/RP0/CPU0:ios#show controllers hundredGigEctr1r 0/1/0/2
Mon Mar 16 19:41:08.047 UTC
Operational data for interface HundredGigEctr1r0/1/0/2:

State:
  Administrative state: enabled
  Operational state: Up
  LED state: Green On
  Maintenance: Disabled
  AINS Soak: None
    Total Duration: 0 hour(s) 0 minute(s)
    Remaining Duration: 0 hour(s) 0 minute(s) 0 second(s)
  Laser Squelch: Disabled
  Neighbor Address:
    0010.9400.5502
```

```
Phy:
  Media type: Not known

Autonegotiation disabled.

Operational values:
  Speed: 100Gbps
  Duplex: Full Duplex
  Flowcontrol: None
```

## Transmit Shutdown

Transmit shut on trunk optics controller brings down the CFP2 transmit power.

From R7.3.2 onwards, you can configure transmit shut on optics controller in the 4x100GE-MXP-DD muxponder mode.

## Configuring Transmit Shutdown on Trunk Optics Controller

To perform transmit shutdown, enter the following commands:

```
RP/0/RP0/CPU0:ios#configure
RP/0/RP0/CPU0:ios(config)#controller Optics R/S/I/P
RP/0/RP0/CPU0:ios(config-Optics)#transmit-shutdown
RP/0/RP0/CPU0:ios(config-Optics)#commit
RP/0/RP0/CPU0:ios(config-Optics)#exit
RP/0/RP0/CPU0:ios(config)#exit
```

The following is a sample to perform transmit shutdown on the trunk port:

```
RP/0/RP0/CPU0:ios#configure
RP/0/RP0/CPU0:ios(config)#controller Optics 0/1/0/12
RP/0/RP0/CPU0:ios(config-Optics)#transmit-shutdown
RP/0/RP0/CPU0:ios(config-Optics)#commit
RP/0/RP0/CPU0:ios(config-Optics)#exit
RP/0/RP0/CPU0:ios(config)#exit
```

The following is a sample to perform transmit shutdown on the trunk port in the 4x100GE-MXP-DD muxponder mode:

```
RP/0/RP0/CPU0:ios#configure
RP/0/RP0/CPU0:ios(config)#controller Optics 0/1/0/9
RP/0/RP0/CPU0:ios(config-Optics)#transmit-shutdown
RP/0/RP0/CPU0:ios(config-Optics)#commit
RP/0/RP0/CPU0:ios(config-Optics)#exit
RP/0/RP0/CPU0:ios(config)#exit
```

## Verifying Transmit Shutdown on Trunk Optics Controller

```
RP/0/RP0/CPU0:ios#sh controllers optics 0/1/0/12
Fri Feb 26 21:36:16.009 UTC

Controller State: Up

Transport Admin State: In Service

Laser State: Off
```

```

LED State: Yellow

Optics Status

Optics Type: CFP2 DWDM
DWDM carrier Info: C BAND, MSA ITU Channel=61, Frequency=193.10THz,
Wavelength=1552.524nm

Alarm Status:
-----
Detected Alarms:
LOW-TX-PWR

LOS/LOL/Fault Status:

Alarm Statistics:

-----
HIGH-RX-PWR = 0 LOW-RX-PWR = 1
HIGH-TX-PWR = 0 LOW-TX-PWR = 1
HIGH-LBC = 0 HIGH-DGD = 0
OOR-CD = 0 OSNR = 0
WVL-OOL = 0 MEA = 0
IMPROPER-REM = 0
TX-POWER-PROV-MISMATCH = 0
Laser Bias Current = 0.0 %
Actual TX Power = -40.00 dBm
RX Power = -1.02 dBm
RX Signal Power = -12.20 dBm
Frequency Offset = -8 MHz

Performance Monitoring: Enable

THRESHOLD VALUES
-----

Parameter High Alarm Low Alarm High Warning Low Warning
-----
Rx Power Threshold(dBm) 4.9 -12.0 0.0 0.0
Tx Power Threshold(dBm) 3.5 -10.1 0.0 0.0
LBC Threshold(mA) N/A N/A 0.00 0.00

LBC High Threshold = 98 %
Configured Tx Power = -1.50 dBm
Configured CD High Threshold = 180000 ps/nm
Configured CD lower Threshold = -180000 ps/nm
Configured OSNR lower Threshold = 0.00 dB
Configured DGD Higher Threshold = 180.00 ps
Baud Rate = 63.1394691467 GBd
Bits per Symbol = 4.0000000000 bits/symbol
Modulation Type: 16QAM
Chromatic Dispersion 0 ps/nm
Configured CD-MIN -26000 ps/nm CD-MAX 26000 ps/nm
Polarization Mode Dispersion = 0.0 ps
Second Order Polarization Mode Dispersion = 16.00 ps^2
Optical Signal to Noise Ratio = 35.90 dB
SNR = 17.00 dB
Polarization Dependent Loss = 0.70 dB
Polarization Change Rate = 0.00 rad/s
Differential Group Delay = 1.00 ps

Transceiver Vendor Details

```

```

Form Factor : CFP2
Name : CISCO-ACACIA
Part Number : 10-3500-01
Rev Number : 01
Serial Number : ACA24230026
PID : ONS-CFP2D-400G-C
VID : VES1
Date Code(yy/mm/dd) : 10/09/í
Fiber Connector Type: LC
Otn Application Code: Not Set
Sonet Application Code: Not Set
Ethernet Compliance Code: Not set

Transceiver Temperature : 55 Celsius

```

```

AINS Soak : None
AINS Timer : 0h, 0m
AINS remaining time : 0 seconds

```

```

RP/0/RP0/CPU0:ios#show controller optics 0/1/0/9
Wed Sep 15 00:41:22.027 UTC

```

```

Controller State: Up

Transport Admin State: In Service

Laser State: On

LED State: Green

Optics Status

```

```

Optics Type: QSFP-DD DWDM
DWDM carrier Info: C BAND, MSA ITU Channel=49, Frequency=193.70THz,
Wavelength=1547.715nm

```

```

Alarm Status:
-----
Detected Alarms: None

```

```

LOS/LOL/Fault Status:

```

```

Alarm Statistics:

```

```

-----
HIGH-RX-PWR = 0          LOW-RX-PWR = 3
HIGH-TX-PWR = 0          LOW-TX-PWR = 5
HIGH-LBC = 0             HIGH-DGD = 0
OOR-CD = 0               OSNR = 4
WVL-OOL = 0              MEA = 0
IMPROPER-REM = 6
TX-POWER-PROV-MISMATCH = 0
Laser Bias Current = 0.0 %
Actual TX Power = -11.10 dBm
RX Power = -11.56 dBm
RX Signal Power = -11.62 dBm
Frequency Offset = -66 MHz

```

```

Performance Monitoring: Enable

```

```

THRESHOLD VALUES

```

```

-----
Parameter                High Alarm  Low Alarm  High Warning  Low Warning
-----
Rx Power Threshold(dBm)   3.0        -24.5     0.0           0.0
Tx Power Threshold(dBm)   0.0        -16.0     0.0           0.0
LBC Threshold(mA)        N/A        N/A       0.00          0.00

```

```

LBC High Threshold = 90 %
Configured Tx Power = -10.00 dBm
Configured CD High Threshold = 52000 ps/nm
Configured CD lower Threshold = -52000 ps/nm
Configured OSNR lower Threshold = 21.10 dB
Configured DGD Higher Threshold = 67.00 ps
Baud Rate = 60.1385467980 GBd
Bits per Symbol = 4.0000000000 bits/symbol
Modulation Type: 16QAM
Chromatic Dispersion 0 ps/nm
Configured CD-MIN -13000 ps/nm CD-MAX 13000 ps/nm
Polarization Mode Dispersion = 0.0 ps
Second Order Polarization Mode Dispersion = 24.00 ps^2
Optical Signal to Noise Ratio = 35.70 dB
SNR = 19.40 dB
Polarization Dependent Loss = 0.20 dB
Polarization Change Rate = 0.00 rad/s
Differential Group Delay = 1.00 ps

```

#### Transceiver Vendor Details

```

Form Factor           : QSFP-DD
Name                  : CISCO-ACACIA
Part Number           : DP04QSDD-E
Rev Number            : A
Serial Number         : ACA2524006W
PID                   : QDD-400G-ZRP-S
VID                   : V01
Date Code(yy/mm/dd)  : 21/06/18
Fiber Connector Type : LC
Otn Application Code : Not Set
Sonet Application Code: Not Set
Ethernet Compliance Code: Not set

```

```

Transceiver Temperature : 62 Celsius
AINS Soak                : None
AINS Timer                : 0h, 0m

```

## Loopback

You can configure the loopback on the CoherentDSP, FC, OTU, and Ethernet controllers to identify connection problems. The loopback can be configured only in the maintenance mode. Use the **controller controller-type** and the **secondary-admin-state maintenance** commands to place the controllers in the maintenance mode.



---

**Note** Internal and line loopbacks are supported on the FC, OTU, and Ethernet controllers whereas only internal loopbacks are supported on the CoherentDSP controllers.

---

### Configuring Loopback on the 1.2T Card



To configure the loopback, use the following commands:

**configure**

**controller** *controllertype Rack/Slot/Instance/Port*

**sec-admin-state maintenance**

**loopback** [ *line* | *internal* ]

**commit**

### Example 1

The following example shows how a line loopback is configured on the Ethernet controller.

```
RP/0/RP0/CPU0:ios#configure
RP/0/RP0/CPU0:ios(config)#controller HundredGigEctrlr 1/0/1/10 secondary-admin-state
maintenance
RP/0/RP0/CPU0:ios(config)#commit
Fri Feb 22 19:49:46.504 UTC
RP/0/RP0/CPU0:ios(config)#exit
```

The following example shows how to verify a line loopback configured on the Ethernet controller.

```
RP/0/RP0/CPU0:ios#show controller HundredGigEctrlr 0/1/0/10
Fri Feb 22 19:50:08.328 UTC
Operational data for interface HundredGigEctrlr0/1/0/10:

State:
  Administrative state: enabled
  Operational state: Up
  LED state: Green On
  Maintenance: Enabled
  AINS Soak: Pending
    Total Duration: 0 hour(s) 30 minute(s)
    Remaining Duration: 0 hour(s) 30 minute(s) 0 second(s)
  Laser Squelch: Enabled

Phy:
  Media type: Not known
  Statistics:
    FEC:
      Corrected Codeword Count: 0
      Uncorrected Codeword Count: 0

Autonegotiation disabled.

Operational values:
  Speed: 100Gbps
  Duplex: Full Duplex
  Flowcontrol: None
  Loopback: None (or external)
  BER monitoring:
    Not supported
  Forward error correction: Standard (Reed-Solomon)
  Holdoff Time: 0ms
RP/0/RP0/CPU0:ios#configure
RP/0/RP0/CPU0:ios(config)#controller HundredGigEctrlr 0/1/0/10 loopback line
RP/0/RP0/CPU0:ios(config)#commit
RP/0/RP0/CPU0:ios(config)#exit
RP/0/RP0/CPU0:ios#show controller HundredGigEctrlr 0/1/0/10
Fri Feb 22 20:01:00.521 UTC
```

Operational data for interface HundredGigECtrlr0/1/0/10:

State:

Administrative state: enabled  
 Operational state: Up  
 LED state: Green On  
 Maintenance: Enabled  
 AINS Soak: Pending  
 Total Duration: 0 hour(s) 30 minute(s)  
 Remaining Duration: 0 hour(s) 30 minute(s) 0 second(s)  
 Laser Squelch: Enabled

Phy:

Media type: Not known  
 Statistics:  
 FEC:  
 Corrected Codeword Count: 0  
 Uncorrected Codeword Count: 6

Autonegotiation disabled.

Operational values:

Speed: 100Gbps  
 Duplex: Full Duplex  
 Flowcontrol: None  
**Loopback: Line**  
 BER monitoring:  
 Not supported  
 Forward error correction: Standard (Reed-Solomon)  
 Holdoff Time: 0ms

## Example 2

The following example shows how to verify an internal loopback configured on the coherent DSP controller.

```
RP/0/RP0/CPU0:ios#show controllers coherentDSP 0/0/0/0
Fri Mar 13 22:00:20.951 UTC

Port                               : CoherentDSP 0/0/0/0
Controller State                   : Up
Inherited Secondary State         : Normal
Configured Secondary State      : Maintenance
Derived State                  : Maintenance
Loopback mode                  : Internal
BER Thresholds                     : SF = 1.0E-5  SD = 1.0E-7
Performance Monitoring             : Enable
Bandwidth                           : 200.0Gb/s

Alarm Information:
LOS = 0 LOF = 1 LOM = 0
OOF = 0 OOM = 0 AIS = 0
IAE = 0 BIAE = 0          SF_BER = 0
SD_BER = 0          BDI = 3 TIM = 0
FECMISMATCH = 0 FEC-UNC = 0
Detected Alarms                   : None

Bit Error Rate Information
PREFEC BER                        : 0.00E+00
POSTFEC BER                       : 0.00E+00
Q-Factor                          : 16.70 dB

Q-Margin                           : 0.99dB

TTI :
```

```

Remote hostname           : ios
Remote interface         : CoherentDSP 0/0/0/0
Remote IP addr           : 0.0.0.0

FEC mode                  : Soft-Decision 27

AINS Soak                 : None
AINS Timer                : 0h, 0m
AINS remaining time      : 0 seconds

```

### Configuring Loopback on OTN-XP Card

From R7.2.1 onwards, OTN-XP card supports loopback on the OTU2, OTU2e, OTU4, 10GE, and CoherentDSP controllers.

From R7.3.2 onwards, OTN-XP card supports loopback on the 100GE and 400GE controllers.

The CoherentDSP controller supports both line and internal.

To configure the loopback on the controllers, use the following commands:

#### configure

**controller** *controller type Rack/Slot/Instance/Port/Lane number*

**sec-admin-state maintenance**

**loopback** [ *line* | *internal* ]

**commit**

The range of *Lane number* is 1–4.

### Example 1

The following example shows how an internal loopback is configured on the 10GE controller.

```

RP/0/RP0/CPU0:ios#configure
RP/0/RP0/CPU0:ios(config)#controller tenGigECtrlr 0/0/0/5/2
RP/0/RP0/CPU0:ios(config-eth-ctrlr)#sec-admin-state maintenance
RP/0/RP0/CPU0:ios(config-eth-ctrlr)#loopback internal
RP/0/RP0/CPU0:ios(config-eth-ctrlr)#commit

```

The following example shows how to verify an internal loopback configured on the 10GE controller.

```

RP/0/RP0/CPU0:ios#show controllers tenGigECtrlr 0/0/0/5/2
Thu Apr 23 10:47:48.020 UTC
Operational data for interface TenGigECtrlr0/0/0/5/2:

State:
  Administrative state: enabled
  Operational state: Up
  LED state: Green On
  Maintenance: Enabled
  AINS Soak: None
    Total Duration: 0 hour(s) 0 minute(s)
    Remaining Duration: 0 hour(s) 0 minute(s) 0 second(s)
  Laser Squelch: Disabled

Phy:
  Media type: Not known

Autonegotiation disabled.

```

```
Operational values:
  Speed: 10Gbps
  Duplex: Full Duplex
  Flowcontrol: None
  Loopback: Internal
  Inter-packet gap: standard (12)
  BER monitoring:
    Not supported
  Holdoff Time: 0ms
```

## Example 2

The following example shows how a line loopback is configured on the OTU2e controller.

```
RP/0/RP0/CPU0:ios#configure
RP/0/RP0/CPU0:ios(config)#controller otu2e 0/0/0/11/3
RP/0/RP0/CPU0:ios(config-otu2e)#secondary-admin-state maintenance
RP/0/RP0/CPU0:ios(config-otu2e)#loopback line
RP/0/RP0/CPU0:ios(config-otu2e)#commit
Thu Apr 23 10:55:19.319 UTC
RP/0/RP0/CPU0:ios(config-otu2e)#end
```

The following example shows how to verify a line loopback configured on the OTU2e controller.

```
RP/0/RP0/CPU0:ios#show controllers otu2e 0/0/0/11/3
Thu Apr 23 10:55:28.014 UTC

Port                               : OTU2E 0/0/0/11/3
Controller State                    : Up
Inherited Secondary State          : Normal
Configured Secondary State         : Maintenance
Derived State                       : Maintenance
Loopback mode                       : Line
BER Thresholds                     : SF = 1.0E-5  SD = 1.0E-7
Performance Monitoring              : Enable
Bandwidth                           : 10.0Gb/s

Alarm Information:
LOS = 0 LOF = 1 LOM = 0
OOF = 1 OOM = 1 AIS = 0
IAE = 0 BIAE = 0          SF_BER = 0
SD_BER = 0          BDI = 0 TIM = 0
FECMISMATCH = 0 FEC-UNC = 0
Detected Alarms                  : None

Bit Error Rate Information
PREFEC BER                       : 0.00E+00
POSTFEC BER                      : 0.00E+00

TTI :
  Remote hostname                  : ios
  Remote interface                 : OTU2E 0/0/0/11/3
  Remote IP addr                   : 0.0.0.0

FEC mode                           : STANDARD

AINS Soak                         : None
AINS Timer                        : 0h, 0m
AINS remaining time               : 0 seconds
```

**Example 3**

The following example shows how an internal loopback is configured on the OTU2 controller.

```
RP/0/RP0/CPU0:ios#configure
RP/0/RP0/CPU0:ios(config)#controller otu2 0/0/0/5/1
RP/0/RP0/CPU0:ios(config-otu2)#secondary-admin-state maintenance
RP/0/RP0/CPU0:ios(config-otu2)#loopback internal
RP/0/RP0/CPU0:ios(config-otu2)#commit
Thu Apr 23 11:01:00.562 UTC
RP/0/RP0/CPU0:ios(config-otu2)#end
```

The following example shows how to verify an internal loopback configured on the OTU2 controller.

```
RP/0/RP0/CPU0:ios#show controllers otu2 0/0/0/5/1
Thu Apr 23 11:01:04.126 UTC

Port                               : OTU2 0/0/0/5/1
Controller State                   : Up
Inherited Secondary State         : Normal
Configured Secondary State        : Maintenance
Derived State                     : Maintenance
Loopback mode                     : Internal
BER Thresholds                    : SF = 1.0E-5  SD = 1.0E-7
Performance Monitoring            : Enable
Bandwidth                         : 10.0Gb/s

Alarm Information:
LOS = 0 LOF = 0 LOM = 0
OOF = 0 OOM = 0 AIS = 0
IAE = 0 BIAE = 0          SF_BER = 0
SD_BER = 0          BDI = 0 TIM = 0
FECMISMATCH = 0 FEC-UNC = 0
Detected Alarms                  : None

Bit Error Rate Information
PREFEC BER                       : 0.00E+00
POSTFEC BER                      : 0.00E+00

TTI :
    Remote hostname                : SM-TRC SAPI-SECSM-TRC DA
    Remote IP addr                 : 192.0.2.67

FEC mode                          : STANDARD

AINS Soak                        : None
AINS Timer                       : 0h, 0m
AINS remaining time               : 0 seconds
```

**Example 4**

The following example shows how an internal loopback is configured on the OTU4 controller.

```
RP/0/RP0/CPU0:ios#configure
RP/0/RP0/CPU0:ios(config)#controller otu4 0/0/0/0
RP/0/RP0/CPU0:ios(config-otu4)#secondary-admin-state maintenance
RP/0/RP0/CPU0:ios(config-otu4)#loopback internal
RP/0/RP0/CPU0:ios(config-otu4)#commit
Thu Apr 23 11:05:22.429 UTC
RP/0/RP0/CPU0:ios(config-otu4)#end
```

The following example shows how to verify an internal loopback configured on the OTU4 controller.

```

RP/0/RP0/CPU0:ios#show controllers otu4 0/0/0/0
Thu Apr 23 11:05:30.281 UTC

Port                               : OTU4 0/0/0/0
Controller State                    : Up
Inherited Secondary State          : Normal
Configured Secondary State        : Maintenance
Derived State                      : Maintenance
Loopback mode                      : Internal
BER Thresholds                    : SF = 1.0E-5  SD = 1.0E-7
Performance Monitoring             : Enable
Bandwidth                          : 100.0Gb/s

Alarm Information:
LOS = 1 LOF = 0 LOM = 0
OOF = 0 OOM = 0 AIS = 0
IAE = 0 BIAE = 0          SF_BER = 0
SD_BER = 0              BDI = 0 TIM = 0
FECMISMATCH = 0 FEC-UNC = 0
Detected Alarms                : None

Bit Error Rate Information
PREFEC BER                      : 0.00E+00
POSTFEC BER                     : 0.00E+00

TTI :
    Remote hostname              : ios
    Remote interface             : OTU4 0/0/0/0
    Remote IP addr               : 0.0.0.0

FEC mode                         : STANDARD

AINS Soak                       : None
AINS Timer                      : 0h, 0m
AINS remaining time             : 0 seconds

```

### Example: Loopback Configuration in 4X100G MXP on 100GE Controller

The following example shows how the client internal loopback is configured on the 100GE controller:

```

RP/0/RP0/CPU0:ios#configure
RP/0/RP0/CPU0:ios(config)#controller HundredGigECtrlr 0/2/0/1
RP/0/RP0/CPU0:ios(config-eth-ctrlr)#sec-admin-state maintenance
RP/0/RP0/CPU0:ios(config-eth-ctrlr)#loopback internal
RP/0/RP0/CPU0:ios(config-otu4)#commit
Thu Sep 23 11:05:22.429 UTC
RP/0/RP0/CPU0:ios(config-otu4)#end

```

The following example shows how the client line loopback is configured on the 100GE controller:

```

RP/0/RP0/CPU0:ios#configure
RP/0/RP0/CPU0:ios(config)#controller HundredGigECtrlr 0/2/0/1
RP/0/RP0/CPU0:ios(config-eth-ctrlr)#sec-admin-state maintenance
RP/0/RP0/CPU0:ios(config-eth-ctrlr)#loopback line
RP/0/RP0/CPU0:ios(config-otu4)#commit
Thu Sep 23 11:05:22.429 UTC
RP/0/RP0/CPU0:ios(config-otu4)#end

```

The following example shows how the trunk internal is configured on the coherentDSP controller:

```

RP/0/RP0/CPU0:ios#configure

```

```
RP/0/RP0/CPU0:ios(config)#controller coherentDSP 0/2/0/11
RP/0/RP0/CPU0:ios(config-CoDSP)#secondary-admin-state maintenance
RP/0/RP0/CPU0:ios(config-CoDSP)#loopback internal
RP/0/RP0/CPU0:ios(config-otu4)#commit
Thu Sep 23 11:05:22.429 UTC
RP/0/RP0/CPU0:ios(config-otu4)#end
```

The following example shows how the trunk line is configured on the coherentDSP controller:

```
RP/0/RP0/CPU0:ios#configure
RP/0/RP0/CPU0:ios(config)#controller coherentDSP 0/2/0/11
RP/0/RP0/CPU0:ios(config-CoDSP)#secondary-admin-state maintenance
RP/0/RP0/CPU0:ios(config-CoDSP)#loopback line
RP/0/RP0/CPU0:ios(config-otu4)#commit
Thu Sep 23 11:05:22.429 UTC
RP/0/RP0/CPU0:ios(config-otu4)#end
```

### Example: Loopback Configuration in 400G-TXP on 400GE Controller

The following example shows how the client internal loopback is configured on the 400GE controller:

```
RP/0/RP0/CPU0:ios#configure
RP/0/RP0/CPU0:ios(config)#controller FourHundredGigECtrlr 0/2/0/10
RP/0/RP0/CPU0:ios(config-eth-ctrlr)#sec-admin-state maintenance
RP/0/RP0/CPU0:ios(config-eth-ctrlr)#loopback internal
RP/0/RP0/CPU0:ios(config-otu4)#commit
Thu Sep 23 11:05:22.429 UTC
RP/0/RP0/CPU0:ios(config-otu4)#end
```

The following example shows how the client line loopback is configured on the 100GE controller:

```
RP/0/RP0/CPU0:ios#configure
RP/0/RP0/CPU0:ios(config)#controller FourHundredGigECtrlr 0/2/0/10
RP/0/RP0/CPU0:ios(config-eth-ctrlr)#sec-admin-state maintenance
RP/0/RP0/CPU0:ios(config-eth-ctrlr)#loopback line
RP/0/RP0/CPU0:ios(config-otu4)#commit
Thu Sep 23 11:05:22.429 UTC
RP/0/RP0/CPU0:ios(config-otu4)#end
```

The following example shows how the trunk internal is configured on the coherentDSP controller:

```
RP/0/RP0/CPU0:ios#configure
RP/0/RP0/CPU0:ios(config)#controller coherentDSP 0/2/0/10
RP/0/RP0/CPU0:ios(config-CoDSP)#secondary-admin-state maintenance
RP/0/RP0/CPU0:ios(config-CoDSP)#loopback internal
RP/0/RP0/CPU0:ios(config-otu4)#commit
Thu Sep 23 11:05:22.429 UTC
RP/0/RP0/CPU0:ios(config-otu4)#end
```

The following example shows how the trunk line is configured on the coherentDSP controller:

```
RP/0/RP0/CPU0:ios#configure
RP/0/RP0/CPU0:ios(config)#controller coherentDSP 0/2/0/10
RP/0/RP0/CPU0:ios(config-CoDSP)#secondary-admin-state maintenance
RP/0/RP0/CPU0:ios(config-CoDSP)#loopback line
RP/0/RP0/CPU0:ios(config-otu4)#commit
Thu Sep 23 11:05:22.429 UTC
RP/0/RP0/CPU0:ios(config-otu4)#end
```

## Configure Loopback in Inverse Muxponder Configured on the OTN-XP Card

You can configure loopback on the coherentDSP controllers in the inverse muxponder configuration.



**Note** You must configure loopback on both trunk ports 12 and 13, otherwise traffic goes down.

The following example shows how loopback is configured on both the trunk ports:

```
RP/0/RP0/CPU0:ios#configure
Thu Sep 30 14:16:04.678 UTC
RP/0/RP0/CPU0:ios(config)#controller coherentDSP 0/2/0/12
RP/0/RP0/CPU0:ios(config-CoDSP)#secondary-admin-state maintenance
RP/0/RP0/CPU0:ios(config-CoDSP)#loopback internal
RP/0/RP0/CPU0:ios(config-CoDSP)#commit
Thu Sep 30 14:16:19.594 UTC
RP/0/RP0/CPU0:ios(config-CoDSP)#controller coherentDSP 0/2/0/13
RP/0/RP0/CPU0:ios(config-CoDSP)#secondary-admin-state maintenance
RP/0/RP0/CPU0:ios(config-CoDSP)#loopback internal
RP/0/RP0/CPU0:ios(config-CoDSP)#commit
Thu Sep 30 14:16:32.390 UTC
RP/0/RP0/CPU0:ios(config-CoDSP)#
```

The following examples shows how to verify loopback configured on the OTN-XP card in the inverse muxponder configuration:

```
RP/0/RP0/CPU0:ios#show controllers coherentDSP 0/2/0/12
Thu Sep 30 14:17:04.411 UTC

Port                               : CoherentDSP 0/2/0/12
Controller State                    : Up
Inherited Secondary State          : Normal
Configured Secondary State         : Maintenance
Derived State                       : Maintenance
Loopback mode                     : Internal
BER Thresholds                     : SF = 1.0E-5   SD = 1.0E-7
Performance Monitoring             : Enable
Bandwidth                           : 200.0Gb/s

Alarm Information:
LOS = 2 LOF = 0 LOM = 0
OOF = 1 OOM = 0 AIS = 1
IAE = 0 BIAE = 0          SF_BER = 0
SD_BER = 0          BDI = 0 TIM = 0
FECMISMATCH = 0 FEC-UNC = 0          FLEXO_GIDM = 0
FLEXO-MM = 0          FLEXO-LOM = 0          FLEXO-RDI = 1
FLEXO-LOF = 0
Detected Alarms                    : None

Bit Error Rate Information
PREFEC BER                         : 2.46E-08
POSTFEC BER                        : 0.00E+00
Q-Factor                           : 14.60 dB

Q-Margin                            : 8.30dB

TTI :
    Remote hostname                 : ios
    Remote interface                : CoherentDSP 0/2/0/12
    Remote IP addr                  : 0.0.0.0

FEC mode                            : O_FEC
```



```

Flexo-Mode                                     : Enable
Flexo Details:
  Tx GID                                       : 1
  TX IID                                       : 1, 2,
  Rx GID                                       : 1
  RX IID                                       : 1, 2,

Flexo Peers Information:
  Controller                                   : CoherentDSP0_2_0_13
  OTUCn rate                                  : OTUC2

AINS Soak                                     : None
AINS Timer                                    : 0h, 0m
AINS remaining time                           : 0 seconds

RP/0/RP0/CPU0:ios#sh controllers coherentDSP 0/2/0/13
Thu Sep 30 14:17:08.140 UTC

Port                                           : CoherentDSP 0/2/0/13
Controller State                              : Up
Inherited Secondary State                    : Normal
Configured Secondary State                   : Maintenance
Derived State                                : Maintenance
Loopback mode                               : Internal
BER Thresholds                               : SF = 1.0E-5  SD = 1.0E-7
Performance Monitoring                       : Enable
Bandwidth                                     : 200.0Gb/s

Alarm Information:
LOS = 1 LOF = 0 LOM = 0
OOF = 0 OOM = 0 AIS = 0
IAE = 0 BIAE = 0          SF_BER = 0
SD_BER = 0          BDI = 0 TIM = 0
FECMISMATCH = 0 FEC-UNC = 0          FLEXO_GIDM = 0
FLEXO-MM = 0          FLEXO-LOM = 0          FLEXO-RDI = 1
FLEXO-LOF = 0
Detected Alarms                              : None

Bit Error Rate Information
PREFEC BER                                   : 0.00E+00
POSTFEC BER                                  : 0.00E+00
Q-Factor                                     : 15.70 dB

Q-Margin                                     : 9.50dB

TTI :
  Remote IP addr                             : 0.0.0.0

FEC mode                                     : O_FEC

Flexo-Mode                                     : Enable
Flexo Details:
  Tx GID                                       : 1
  TX IID                                       : 3, 4,
  Rx GID                                       : 1
  RX IID                                       : 3, 4,

Flexo Peers Information:
  Controller                                   : CoherentDSP0_2_0_12
  OTUCn rate                                  : OTUC2

```

```
AINS Soak : None
AINS Timer : 0h, 0m
AINS remaining time : 0 seconds
```

### Configuring Loopback on 2-QDD-C Card

From R7.3.1 onwards, 2-QDD-C card supports loopback on the 100 and 400GE controllers.



---

**Note** On applying client-side loopbacks, traffic is looped and does not continue in the 2-QDD-C card. QSFP squelching happens on applying internal loopback.

---

To configure the loopback on the controllers, use the following commands.

**configure**

**controller** *controllertype Rack/Slot/Instance/Port/Lanenumbr*

**sec-admin-state maintenance**

**loopback** [ *line* | *internal* ]

**commit**

### Example

The following example shows how an internal loopback is configured on a 100GE controller.

```
RP/0/RP0/CPU0:ios#configure
RP/0/RP0/CPU0:ios(config)#controller hundredGigECtrlr 0/0/0/5
RP/0/RP0/CPU0:ios(config-eth-ctrlr)#sec-admin-state maintenance
RP/0/RP0/CPU0:ios(config-eth-ctrlr)#loopback internal
RP/0/RP0/CPU0:ios(config-eth-ctrlr)#commit
```

The following example shows how to verify the internal loopback configured on a 100GE controller.

```
RP/0/RP0/CPU0:ios#show controllers hundredGigECtrlr 0/0/0/5
Thu Apr 23 10:47:48.020 UTC
Operational data for interface hundredGigECtrlr0/0/0/5:
```

State:

```
Administrative state: enabled
Operational state: Up
LED state: Green On
Maintenance: Enabled
AINS Soak: None
Total Duration: 0 hour(s) 0 minute(s)
Remaining Duration: 0 hour(s) 0 minute(s) 0 second(s)
Laser Squelch: Disabled
```

Phy:

```
Media type: Not known
```

Autonegotiation disabled.

Operational values:

```
Speed: 10Gbps
Duplex: Full Duplex
Flowcontrol: None
Loopback: Internal
```

```

Inter-packet gap: standard (12)
BER monitoring:
  Not supported
Holdoff Time: 0ms

```

## Restore Factory Settings



**Note** Perform this operation only on the console port.

You can restore the factory settings on the NCS 1004. The entire system configuration, including usernames, passwords, and IP addresses, is removed. You can perform this operation only through the console port and not on the management interface. To restore NCS 1004 to factory settings, use the **commit replace** command. After the **commit replace** operation completes, you must perform the IOS XR reload operation.

The **commit best-effort** command merges the target configuration with the running configuration and commits only valid changes (best effort). Some configuration changes might fail due to semantic errors.

### Example

```

RP/0/RP0/CPU0:ios#configure
RP/0/RP0/CPU0:ios(config)#commit replace
Tue Sep 24 09:36:59.430 UTC

```

This commit will replace or remove the entire running configuration. This operation can be service affecting.

```

Do you wish to proceed? [no]: yes
RP/0/RP0/CPU0:ios(config)#exit
RP/0/RP0/CPU0:ios#reload
Tue Sep 24 09:38:12.881 UTC

```

Standby card not present or not Ready for failover. Proceed? [confirm]

Preparing system for backup. This may take a few minutes especially for large configurations.

```
Status report: node0_RP0_CPU0: BACKUP INPROGRESS
```

```
Status report: node0_RP0_CPU0: BACKUP HAS COMPLETED SUCCESSFULLY
```

[Done]

```

Proceed with reload? [confirm]
Reloading node 0/RP0/CPU0

```

```

RL: Reboot initiated with code 1, cause User initiated graceful reload reboot_timeout 30
shutdown delay 0

```

```
RL: Shutdown initiated
```

```
Query the node to be reloaded
```

```
  NODE_IP of noded to be reloaded 192.0.2.4
```

```
sending stop hb
```

```
Cause: User initiated graceful reload
```

```
VM IP addr sent for reload 192.0.2.4
```

```
Received ack from sdrmgr for reload request.Returncode:0
```

```
successful disconnection from service
```

```
wd_disconnect_cb 548 CMP-WD disconnected successfully
```

```
Invmgr successful disconnection from service
```

```

RP/0/RP0/CPU0:ios#
Disconnecting from 'default-sdr--1' console. Continue(Y/N)?

Connecting to 'default-sdr--1' console
ÿÿÿÿÿÿÿbootlogd: ioctl(/dev/pts/2, TIOCCONS): Device or resource busy
/sbin/restorecon: lstat(/etc/adjtime) failed: No such file or directory
Configuring network interfaces... done.
Starting system message bus: dbus.
Starting OpenBSD Secure Shell server: sshd
sshd start/running, process 1739
Starting rpcbind daemon...done.
Starting random number generator daemonUnable to open file: /dev/tpm0
.
Starting system log daemon...0
Starting kernel log daemon...0
tftpd-hpa disabled in /etc/default/tftpd-hpa
Starting internet superserver: xinetd.
net.ipv4.ip_forward = 1
Libvirt not initialized for container instance
Starting crond: OK
SIOCADDRT: File exists

DBG_MSG: platform type is 0
[*] ima_policy have loaded, or IMA policy file does not exist
Start serial incoming on , Clearing ..
RP/0/RP0/CPU0:Sep 24 09:38:44.284 UTC: fpd-serv[256]: %PKT_INFRA-FM-3-FAULT_MAJOR :
ALARM_MAJOR :FPD-NEED-UPGRADE :DECLARE :0/PM0:

This (D)RP Node is not ready or active for login /configuration
.....
.....
.....

ios con0/RP0/CPU0 is now available

Press RETURN to get started.

!!!!!!!!!!!!!!!!!!!!!! NO root-system username is configured. Need to configure root-system
username.!!!!!!!!!!!!!!!!!!!!!!

```

## Headless Mode

During process restarts, CPU reload, or removal of CPU, the NCS 1004 operates in headless mode for up to 72 hours. During this time, traffic is not impacted, although the control plane is not up and running. Fault propagation continues to operate for failures on client and trunk ports. However, you cannot provision anything nor view operational data with a non-functional CPU. Performance monitoring data based on 15 minutes and 24 hour intervals is not supported with a non-functional CPU.

## Trail Trace Identifier

The Trail trace identifier (TTI) feature helps you to identify the signal from the source to the destination within the network. You can configure the TTI sent or expected string only in ASCII string format. When the expected TTI string does not match the received TTI trace string, the controller goes down and the OTUK-TIM alarm is raised. To configure TTI on the coherent DSP controllers, use the following commands:

**configure**

**controller coherentDSP R/S/I/P tti {sent | expected} ascii tti-string**  
**commit**



**Note** The *tti-string* can have a maximum of 64 characters.

The following sample displays how to configure TTI on a coherent DSP controller with the sent and expected strings set to the same ASCII string. The state of the controller is up.

```
RP/0/RP0/CPU0:ios#config
Fri Mar 15 08:03:02.094 UTC
RP/0/RP0/CPU0:ios(config)#controller coherentDSP 0/1/0/1 tti sent ascii 1234
RP/0/RP0/CPU0:ios(config)#controller coherentDSP 0/1/0/1 tti expected ascii 1234
RP/0/RP0/CPU0:ios(config)#commit
Fri Mar 15 08:03:49.725 UTC
RP/0/RP0/CPU0:ios(config)#exit
RP/0/RP0/CPU0:ios#show controllers coherentDSP 0/1/0/1
Fri Mar 15 08:04:06.290 UTC

Port                               : CoherentDSP 0/1/0/1
Controller State                   : Up
Inherited Secondary State         : Normal
Configured Secondary State       : Normal
Derived State                      : In Service
Loopback mode                     : None
BER Thresholds                   : SF = 1.0E-5  SD = 1.0E-7
Performance Monitoring            : Enable

Alarm Information:
LOS = 0 LOF = 0 LOM = 0
OOF = 0 OOM = 0 AIS = 0
IAE = 0 BIAE = 0          SF_BER = 0
SD_BER = 0          BDI = 1 TIM = 0
FECMISMATCH = 0 FEC-UNC = 0
Detected Alarms                  : None

Bit Error Rate Information
PREFEC BER                       : 7.7E-03
POSTFEC BER                      : 0.0E+00

OTU TTI Sent
  OPERATOR SPECIFIC ASCII        : 1234
  :
  OPERATOR SPECIFIC HEX          : 31323334000000000000000000000000
  : 00000000000000000000000000000000

OTU TTI Received
  OPERATOR SPECIFIC ASCII        : 1234
  :
  OPERATOR SPECIFIC HEX          : 31323334000000000000000000000000
  : 00000000000000000000000000000000

OTU TTI Expected
  OPERATOR SPECIFIC ASCII        : 1234
  :
  OPERATOR SPECIFIC HEX          : 31323334000000000000000000000000
  : 00000000000000000000000000000000

FEC mode                          : Soft-Decision 27

AINS Soak                         : None
AINS Timer                        : 0h, 0m
AINS remaining time               : 0 seconds
```

The following example shows how to configure TTI on a coherent DSP controller with the sent and expected strings set to different ASCII strings. The state of the controller goes down and the TIM alarm is raised.

```
RP/0/RP0/CPU0:ios#config
Fri Mar 15 08:54:29.780 UTC
RP/0/RP0/CPU0:ios(config)#controller coherentDSP 0/1/0/1 tti sent ascii 1234
RP/0/RP0/CPU0:ios(config)#controller coherentDSP 0/1/0/1 tti expected ascii 5678
RP/0/RP0/CPU0:ios(config)#commit
Fri Mar 15 08:56:12.293 UTC
RP/0/RP0/CPU0:ios(config)#exit
RP/0/RP0/CPU0:ios#show controllers coherentDSP 0/1/0/1
Fri Mar 15 08:56:33.910 UTC

Port                               : CoherentDSP 0/1/0/1
Controller State                    : Down
Inherited Secondary State          : Normal
Configured Secondary State         : Normal
Derived State                      : In Service
Loopback mode                      : None
BER Thresholds                     : SF = 1.0E-5   SD = 1.0E-7
Performance Monitoring             : Enable

Alarm Information:
LOS = 1 LOF = 0 LOM = 0
OOF = 0 OOM = 0 AIS = 0
IAE = 0 BIAE = 0          SF_BER = 0
SD_BER = 0          BDI = 3 TIM = 1
FECMISMATCH = 0 FEC-UNC = 0
Detected Alarms                  : BDI TIM

Bit Error Rate Information
PREFEC BER                       : 8.2E-03
POSTFEC BER                      : 0.0E+00

OTU TTI Sent
  OPERATOR SPECIFIC  ASCII       : 1234
  :
  OPERATOR SPECIFIC  HEX         : 31323334000000000000000000000000
  : 00000000000000000000000000000000

OTU TTI Received
  OPERATOR SPECIFIC  ASCII       : 1234
  :
  OPERATOR SPECIFIC  HEX         : 31323334000000000000000000000000
  : 00000000000000000000000000000000

OTU TTI Expected
  OPERATOR SPECIFIC  ASCII       : 5678
  :
  OPERATOR SPECIFIC  HEX         : 35363738000000000000000000000000
  : 00000000000000000000000000000000

FEC mode                          : Soft-Decision 27

AINS Soak                         : None
AINS Timer                        : 0h, 0m
AINS remaining time               : 0 seconds
```

## Configure TTI on OTN-XP Card

You can configure the TTI sent or expected string in the full ASCII format, or Source Access Point Identifier (SAPI)/Destination Access Point Identifier (DAPI) format on OTU, ODU, ODU-flex, ODUCn, and coherentDSP controllers for the OTN-XP card.

From R7.3.1 onwards, coherentDSP controller supports only the full ASCII string format.

From R7.3.2 onwards, coherentDSP controller supports SAPI/DAPI string format in addition to the full ASCII string format.

You can configure TTI for the following muxponder modes:

- 10G-Grey-MXP
- 4x100G-MXP-400G-TXP

The following table lists the ASCII format that is supported on each muxponder mode for TTI:

**Table 20: ASCII Format Supported on Each Muxponder Mode**

Muxponder Mode	ASCII with Character String	Controller
10G Grey	Full ASCII 64-character	OTU2, OTU2E, OTU4, ODU4, ODU2E (10G mapper)
	SAPI ASCII 15-character	OTU2, OTU2E, OTU4, ODU4, ODU2E (10G mapper)
	DAPI ASCII 15-character	OTU2, OTU2E, OTU4, ODU4, ODU2E (10G mapper)
	Operator-specific ASCII 32-character	OTU2, OTU2E, OTU4, ODU4, ODU2E (10G mapper)
4x100G-MXP-400G-TXP	Full ASCII 64-character	OTU4, coherentDSP, ODUC4, ODU4 (100G mapper), and ODU-FLEX (400G mapper)
	SAPI ASCII 15-character	OTU4, coherentDSP, ODUC4, ODU4 (100G mapper), and ODU-FLEX (400G mapper)
	DAPI ASCII 15-character	OTU4, coherentDSP, ODUC4, ODU4 (100G mapper), and ODU-FLEX (400G mapper)
	Operator-specific ASCII 32-character	OTU4, coherentDSP, ODUC4, ODU4 (100G mapper), and ODU-FLEX (400G mapper)

To configure TTI, use the following commands:

**configure**

**controller** *controller-type* *R/S/I/P* **tti** {*sent* | *expected*} {*ascii* | *sapi ascii* | *dapi ascii* | *operator-specific ascii*} *tti-string*

**commit**



**Note** We recommend that you configure TTI in the SAPI/DAPI ASCII format.

The following is a sample configuration on ODU4 controller:

```
RP/0/RP0/CPU0:ios#configure
Thu Sep 30 17:19:11.804 UTC
Current Configuration Session Line User Date Lock
00001000-00005c15-00000000 vty0 root Thu Sep 30 11:50:12 2021
RP/0/RP0/CPU0:ios(config)#controller odU4 0/1/0/12/7 tti sent sapi ascii cisco123
RP/0/RP0/CPU0:ios(config)#controller odU4 0/1/0/12/7 tti expect sapi ascii 123cisco
RP/0/RP0/CPU0:ios(config)#controller odU4 0/1/0/12/7 tti sent dapi ascii dapistring123
RP/0/RP0/CPU0:ios(config)#controller odU4 0/1/0/12/7 tti expected dapi ascii 123stringdapi
RP/0/RP0/CPU0:ios(config)#controller odU4 0/1/0/12/7 tti sent operator-specific ascii
operation123
RP/0/RP0/CPU0:ios(config)#controller odU4 0/1/0/12/7 tti expected operator-specific ascii
123operator
RP/0/RP0/CPU0:ios(config)#commit
Thu Sep 30 17:21:49.521 UTC
RP/0/RP0/CPU0:ios(config)#end
```

The following is a sample output of the TTI configuration on the ODU4 controller:

```
RP/0/RP0/CPU0:ios#show controllers odU4 0/1/0/12/7
Thu Sep 30 17:22:30.658 UTC

Port : ODU4 0/1/0/12/7
Controller State : Down
Inherited Secondary state : Normal
Configured Secondary state : Normal
Derived State : In Service
Loopback mode : None
BER Thresholds : SF = 1.0E-6 SD = 1.0E-7

Performance Monitoring : Enable

Path Monitoring Mode : Operational
PM TIM-CA state : Disable

Alarm Information:
AIS = 3 IAE = 0 BIAE = 0
SF_BER = 0 SD_BER = 0 BDI = 1
OCI = 0 LCK = 2 PTIM = 0
TIM = 1 CSF = 0 GFP LFD = 0
GFP LOCS = 0 GFP LOCCS = 0 GFP UPM = 0

Detected Alarms : TIM

ODU TTI Sent
SAPI ASCII : c i s c o 1 2 3
SAPI HEX : 00636973636F31323300000000000000
DAPI ASCII : d a p i s t r i n g 1 2 3
DAPI HEX : 0064617069737472696E673132330000
OPERATOR SPECIFIC ASCII : operation123
OPERATOR SPECIFIC HEX :
6F7065726174696F6E31323300000000000000000000000000000000000000000000000000
ODU TTI Received

ODU TTI Expected
SAPI ASCII : 1 2 3 c i s c o
```





```

SAPI HEX : 00636973636F00000000000000000000
DAPI ASCII :
DAPI HEX :
OPERATOR SPECIFIC ASCII :
OPERATOR SPECIFIC HEX :
CDCDCDCDED00DBBE210000000000000050D9D29AD7F00007603BADC7698BADC
OTU TTI Received
SAPI ASCII : c i s c o
SAPI HEX : 00636973636F0000000000000000000000
FEC mode : O_FEC

Flexo-Mode : Enable
Flexo Details:
Tx GID : 1
TX IID : 1, 2,
Rx GID : 1
RX IID : 1, 2,

Flexo Peers Information:
Controller : CoherentDSP0_2_0_13
OTUCn rate : OTUC2

AINS Soak : None
AINS Timer : 0h, 0m
AINS remaining time : 0 seconds

```

### Enable TIM CA on Path Monitoring Layer

You can enable Trace Identifier Mismatch (TIM) consequent action (CA) on the Path Monitoring (PM) layer using the **pm-tim-ca** command on mapper ODUs for Ethernet controller. The TTI transmit string in the SAPI/DAPI format is not configurable on ODUs that are transparent.

For example, the clients that are supported are ODU4, ODU2, and ODU2E, and lower-order ODUs such as ODU2 or ODU2E.

You can configure **pm-tim-ca** only on mapper ODUs such as ODU2E (10G mapper), ODU4 (100G mapper), and ODU-FLEX (400G mapper).

To configure **pm-tim-ca** on mapper ODU in the 4x100G-MXP-400G-TXP muxponder mode, use the following commands

**configure**

**controller** *controller-type* *R/S/I/P*

**pm-tim-ca**

**commit**

## Chromatic Dispersion

You can configure chromatic dispersion on optics controllers. When you configure the maximum and minimum values for chromatic dispersion for any data rate, ensure the minimum difference between the configured values is equal to or greater than 1500 ps/nm.

The following table lists the default CD search range.

Data Rate	BPS	Card Support	Default CD Search Range
200G to 500G	BPS <= 3	1.2T, 1.2TL	-10,000 to 100,000 ps/nm
	3 < BPS <= 4	1.2T, 1.2TL	-10,000 to 80,000 ps/nm
	4 < BPS <=5	1.2T	-5,000 to 20,000 ps/nm
600G	BPS=5.2578125	1.2T	-2000 to 2,000 ps/nm
400G for 400G CFP2 DCO	BPS=4	OTN-XP	-24,000 to 24,000 ps/nm
400GE for ZRP	BPS=4	OTN-XP	For CFEC, -2,400 to 2,400 ps/nm For OFEC, -13,000 to 13,000 ps/nm
200G to 400G	3 < BPS <= 6	2-QDD-C	-350000 to +350000 ps/nm



**Note** The cd-min and cd-max values must be set for BPS values that are greater than 4 in the 1.2T card.



**Note** When the user provisions the cd-min and cd-max values that are outside the range through CLI, the provisioned values are accepted; however, only the actual values supported by the hardware are applied.

The following is a sample where chromatic dispersion is configured on the optics controller.

```
RP/0/RP0/CPU0:ios#configure
Mon Aug 19 19:31:42.115 UTC
RP/0/RP0/CPU0:ios(config)#controller optics 0/1/0/1
RP/0/RP0/CPU0:ios(config-Optics)#cd-max 4000
RP/0/RP0/CPU0:ios(config-Optics)#cd-min -1000
RP/0/RP0/CPU0:ios(config-Optics)#commit
Mon Aug 19 19:35:24.697 UTC
RP/0/RP0/CPU0:ios(config-Optics)#exit
RP/0/RP0/CPU0:ios(config)#exit
RP/0/RP0/CPU0:ios#show run controller optics 0/1/0/*
Mon Aug 19 19:57:41.859 UTC
controller Optics0/1/0/0
  transmit-power -15
  dwdm-carrier 50GHz-grid itu-ch 55
  enh-sop-tol-mode 1
  cross-pol-gain-mode 10
  lbc-high-threshold 5
!
controller Optics0/1/0/1
  description trunk power UP
  cd-min -1000
  cd-max 4000
  enh-colorless-mode 2
  enh-sop-tol-mode 3
  nleq-comp-mode 4
```

```

cross-pol-gain-mode 2
cross-pol-weight-mode 3
cpr-win-mode 3
cpr-ext-win-mode 8
rx-voa fixed-ratio 1200
filter-roll-off-factor 0.035
!
controller Optics0/1/0/5
  soak-time 10
!

```

## Transmit Power

From Release 7.3.1 onwards, you can configure transmit power on the CFP2 DCO optics for the OTN-XP card. The value ranges from -10 to +1 dBm.

From Release 7.3.2 onwards, you can configure transmit power on the QDD ZRP optics for the OTN-XP card. The following are the value ranges for OFEC and CFEC:

FEC Types	Transmit Power (dBm)
OFEC	-13 to -9
CFEC	-10 to -6

To configure transmit power on the CFP2 DCO optics for the OTN-XP card, use the following commands:

```

RP/0/RP0/CPU0:ios#configure
Mon Aug 19 19:31:42.115 UTC
RP/0/RP0/CPU0:ios(config)#controller optics 0/1/0/12
RP/0/RP0/CPU0:ios(config-Optics)#transmit-power -1.50
RP/0/RP0/CPU0:ios(config-Optics)#commit
Mon Aug 19 19:35:24.697 UTC
RP/0/RP0/CPU0:ios(config-Optics)#exit
RP/0/RP0/CPU0:ios(config)#exit

```

The following is a sample in which transmit power of -1.50 dBm is configured on the CFP2 DCO optics for the OTN-XP card.

```

RP/0/RP0/CPU0:ios(config-hwmod-mxp)#do show controllers optics 0/1/0/12
Mon Jan 18 19:05:26.009 UTC

Controller State: Down

Transport Admin State: In Service

Laser State: On

LED State: Green

Optics Status

Optics Type: CFP2 DWDM
DWDM carrier Info: C BAND, MSA ITU Channel=61, Frequency=193.10THz,
Wavelength=1552.524nm

Alarm Status:
-----

```

Detected Alarms: None

LOS/LOL/Fault Status:

Alarm Statistics:

```

-----
HIGH-RX-PWR = 0 LOW-RX-PWR = 0
HIGH-TX-PWR = 0 LOW-TX-PWR = 0
HIGH-LBC = 0 HIGH-DGD = 0
OOR-CD = 0 OSNR = 0
WVL-OOL = 0 MEA = 0
IMPROPER-REM = 0
TX-POWER-PROV-MISMATCH = 0
Laser Bias Current = 0.0 %
Actual TX Power = -1.47 dBm
RX Power = -0.86 dBm
RX Signal Power = 0.86 dBm
Frequency Offset = 0 MHz

```

Performance Monitoring: Enable

THRESHOLD VALUES

```

-----
Parameter High Alarm Low Alarm High Warning Low Warning
-----

```

```

Rx Power Threshold(dBm) 4.9 -12.0 0.0 0.0
Tx Power Threshold(dBm) 3.5 -10.1 0.0 0.0
LBC Threshold(mA) N/A N/A 0.00 0.00

```

```

LBC High Threshold = 98 %
Configured Tx Power = -1.50 dBm
Configured CD High Threshold = 180000 ps/nm
Configured CD lower Threshold = -180000 ps/nm
Configured OSNR lower Threshold = 0.00 dB
Configured DGD Higher Threshold = 180.00 ps
Baud Rate = 63.0999984741 GBd
Bits per Symbol = 4.0000000000 bits/symbol
Modulation Type: 16QAM
Chromatic Dispersion 0 ps/nm
Configured CD-MIN -26000 ps/nm CD-MAX 26000 ps/nm
Polarization Mode Dispersion = 0.0 ps
Second Order Polarization Mode Dispersion = 156.00 ps^2
Optical Signal to Noise Ratio = 35.80 dB
SNR = 10.50 dB
Polarization Dependent Loss = 0.00 dB
Polarization Change Rate = 0.00 rad/s
Differential Group Delay = 1.00 ps
Filter Roll Off Factor : 0.000
Rx VOA Fixed Ratio : 0.00 dB
Enhanced Colorless Mode : 0
Enhanced SOP Tolerance Mode : 0

```

### Transmit Power on QDD ZRP Optics

To configure transmit power on the QDD ZRP optics for the OTN-XP card, use the following commands:

```

RP/0/RP0/CPU0:ios#configure
Mon Aug 19 19:31:42.115 UTC
RP/0/RP0/CPU0:ios(config)#controller optics 0/1/0/9
RP/0/RP0/CPU0:ios(config-Optics)#transmit-power -8

```

```
RP/0/RP0/CPU0:ios(config-Optics)#commit
Mon Aug 19 19:35:24.697 UTC
RP/0/RP0/CPU0:ios(config-Optics)#
```

The following is a sample in which transmit power of -8 dBm is configured on the QDD ZRP optics for the OTN-XP card:

```
RP/0/RP0/CPU0:ios#show controller optics 0/1/0/9
Wed Sep 15 00:36:24.383 UTC

Controller State: Up

Transport Admin State: In Service

Laser State: On

LED State: Green

Optics Status

    Optics Type: QSFP-DD DWDM
    DWDM carrier Info: C BAND, MSA ITU Channel=49, Frequency=193.70THz,
    Wavelength=1547.715nm

    Alarm Status:
    -----
    Detected Alarms: None

    LOS/LOL/Fault Status:

    Alarm Statistics:

    -----
    HIGH-RX-PWR = 0          LOW-RX-PWR = 1
    HIGH-TX-PWR = 0          LOW-TX-PWR = 1
    HIGH-LBC = 0             HIGH-DGD = 0
    OOR-CD = 0               OSNR = 1
    WVL-OOL = 0              MEA = 0
    IMPROPER-REM = 0
    TX-POWER-PROV-MISMATCH = 0
    Laser Bias Current = 0.0 %
    Actual TX Power = -8 dBm
    RX Power = -7.31 dBm
    RX Signal Power = -7.67 dBm
    Frequency Offset = 81 MHz
    Performance Monitoring: Enable

    THRESHOLD VALUES
    -----

    Parameter                High Alarm  Low Alarm  High Warning  Low Warning
    -----
    Rx Power Threshold(dBm)   3.0        -23.5     0.0           0.0
    Tx Power Threshold(dBm)   0.0        -16.0     0.0           0.0
    LBC Threshold(mA)         N/A        N/A       0.00          0.00

    LBC High Threshold = 90 %
    Configured Tx Power = -7.00 dBm
    Configured CD High Threshold = 2400 ps/nm
    Configured CD lower Threshold = -2400 ps/nm
    Configured OSNR lower Threshold = 24.00 dB
    Configured DGD Higher Threshold = 40.00 ps
    Baud Rate = 59.8437500000 GBd
```

```

Bits per Symbol = 4.0000000000 bits/symbol
Modulation Type: 16QAM
Chromatic Dispersion 0 ps/nm
Configured CD-MIN -2400 ps/nm CD-MAX 2400 ps/nm
Polarization Mode Dispersion = 0.0 ps
Second Order Polarization Mode Dispersion = 29.00 ps^2
Optical Signal to Noise Ratio = 36.40 dB
SNR = 17.30 dB
Polarization Dependent Loss = 0.40 dB
Polarization Change Rate = 0.00 rad/s
Differential Group Delay = 3.00 ps

```

#### Transceiver Vendor Details

```

Form Factor           : QSFP-DD
Name                  : CISCO
Part Number           : 10-3496-01
Rev Number            : 11
Serial Number         : 210153241
PID                   : QDD-400G-ZRP-S
VID                   : ES04
Date Code(yy/mm/dd)  : 20/21/01
Fiber Connector Type : LC
Otn Application Code  : Not Set
Sonet Application Code: Not Set
Ethernet Compliance Code: Not set
Transceiver Temperature : 57 Celsius
AINS Soak             : None
AINS Timer             : 0h, 0m
AINS remaining time   : 0 seconds

```

## Laser Bias Current High Threshold

You can configure the threshold of the laser bias current flowing on the physical pluggable port on the trunk optics controller. The range is 0 to 100%

To configure the laser bias current threshold, use the following command:

**configure**

**controller optics** *R/S/I/P*

**lbc-high-threshold** *lbc-value*

**commit**

The following sample configures the high laser bias threshold on the controller optics:

```

RP/0/RP0/CPU0:ios#configure
RP/0/RP0/CPU0:ios(config)#controller optics 0/0/0/12
RP/0/RP0/CPU0:ios(config-Optics)#lbc-high-threshold 55
RP/0/RP0/CPU0:ios(config-Optics)#commit

```

The following sample shows the high laser bias threshold configured on the controller optics:

```

RP/0/RP0/CPU0:ios#show controllers optics 0/0/0/12
Fri Nov 12 10:58:50.595 UTC

Controller State: Up

Transport Admin State: In Service

Laser State: On

```

LED State: Yellow

Optics Status

Optics Type: CFP2 DWDM  
 DWDM carrier Info: C BAND, MSA ITU Channel=61, Frequency=193.10THz,  
 Wavelength=1552.524nm

Alarm Status:

-----

Detected Alarms:

HIGH-RX-PWR      LOW-TX-PWR  
 HIGH-DGD

LOS/LOL/Fault Status:

Alarm Statistics:

-----

HIGH-RX-PWR = 1                      LOW-RX-PWR = 0  
 HIGH-TX-PWR = 0                      LOW-TX-PWR = 1  
 HIGH-LBC = 0                         HIGH-DGD = 6  
 OOR-CD = 0                            OSNR = 0  
 WV-LOL = 0                            MEA = 0  
 IMPROPER-REM = 1  
 TX-POWER-PROV-MISMATCH = 0  
 Laser Bias Current = 0.0 %  
 Actual TX Power = 0.97 dBm  
 RX Power = -0.53 dBm  
 RX Signal Power = -1.20 dBm  
 Frequency Offset = 63 MHz

Performance Monitoring: Enable

THRESHOLD VALUES

-----

Parameter	High Alarm	Low Alarm	High Warning	Low Warning
Rx Power Threshold(dBm)	-2.0	-3.0	0.0	0.0
Tx Power Threshold(dBm)	4.0	2.0	0.0	0.0
LBC Threshold(mA)	N/A	N/A	0.00	0.00

**LBC High Threshold = 55 %**

Configured Tx Power = 1.00 dBm  
 Configured CD High Threshold = 2400 ps/nm  
 Configured CD lower Threshold = -2400 ps/nm  
 Configured OSNR lower Threshold = 0.40 dB  
 Configured DGD Higher Threshold = 0.30 ps  
 Baud Rate = 63.1394679230 GBd  
 Bits per Symbol = 3.0000000000 bits/symbol  
 Modulation Type: 8QAM  
 Chromatic Dispersion 0 ps/nm  
 Configured CD-MIN -48000 ps/nm CD-MAX 48000 ps/nm  
 Polarization Mode Dispersion = 0.0 ps  
 Second Order Polarization Mode Dispersion = 29.00 ps^2  
 Optical Signal to Noise Ratio = 36.10 dB  
 SNR = 17.50 dB  
 Polarization Dependent Loss = 0.50 dB  
 Polarization Change Rate = 0.00 rad/s  
 Differential Group Delay = 1.00 ps

Transceiver Vendor Details



```

Form Factor           : CFP2
Name                  : CISCO-ACACIA
Part Number           : 10-3500-01
Rev Number            : 01
Serial Number         : ACA24480037
PID                   : ONS-CFP2D-400G-C
VID                   : VES1
Date Code (yy/mm/dd) : 20/11/10
Fiber Connector Type : LC
Otn Application Code  : Not Set
Sonet Application Code: Not Set
Ethernet Compliance Code: Not set

```

Transceiver Temperature : 46 Celsius

```

AINS Soak             : None
AINS Timer             : 0h, 0m
AINS remaining time   : 0 seconds

```

## Differential Group Delay Threshold

You can configure the threshold value for the maximum acceptable differential group delay (DGD) on the trunk optics controllers. The DGD alarm is raised if DGD exceeds this value.

The range is 0–18000 (in the units of 0.01 ps).

To configure the maximum acceptable DGD, use the following command:

### **configure**

**controller optics** *R/S/I/P*

**dgd-high-threshold** *dgd-value*

### **commit**

The following sample configures the minimum acceptable DGD on the controller optics:

```

RP/0/RP0/CPU0:ios#configure
RP/0/RP0/CPU0:ios(config)#controller optics 0/0/0/12
RP/0/RP0/CPU0:ios(config-Optics)#dgd-high-threshold 30
RP/0/RP0/CPU0:ios(config-Optics)#commit

```

The following sample shows the maximum acceptable DGD configured on the controller optics:

```

RP/0/RP0/CPU0:ios#show controllers optics 0/0/0/12
Fri Nov 12 10:58:50.595 UTC

```

Controller State: Up

Transport Admin State: In Service

Laser State: On

LED State: Yellow

Optics Status

```

Optics Type: CFP2 DWDM
DWDM carrier Info: C BAND, MSA ITU Channel=61, Frequency=193.10THz,

```

Wavelength=1552.524nm

Alarm Status:

-----

Detected Alarms:

HIGH-RX-PWR    LOW-TX-PWR  
HIGH-DGD

LOS/LOL/Fault Status:

Alarm Statistics:

-----

HIGH-RX-PWR = 1                    LOW-RX-PWR = 0  
HIGH-TX-PWR = 0                    LOW-TX-PWR = 1  
HIGH-LBC = 0                        HIGH-DGD = 6  
OOR-CD = 0                         OSNR = 0  
WVL-OOL = 0                        MEA = 0  
IMPROPER-REM = 1  
TX-POWER-PROV-MISMATCH = 0  
Laser Bias Current = 0.0 %  
Actual TX Power = 0.97 dBm  
RX Power = -0.53 dBm  
RX Signal Power = -1.20 dBm  
Frequency Offset = 63 MHz

Performance Monitoring: Enable

THRESHOLD VALUES

-----

Parameter	High Alarm	Low Alarm	High Warning	Low Warning
Rx Power Threshold(dBm)	-2.0	-3.0	0.0	0.0
Tx Power Threshold(dBm)	4.0	2.0	0.0	0.0
LBC Threshold(mA)	N/A	N/A	0.00	0.00

LBC High Threshold = 55 %

Configured Tx Power = 1.00 dBm

Configured CD High Threshold = 2400 ps/nm

Configured CD lower Threshold = -2400 ps/nm

Configured OSNR lower Threshold = 0.40 dB

**Configured DGD Higher Threshold = 0.30 ps**

Baud Rate = 63.1394679230 GBd

Bits per Symbol = 3.0000000000 bits/symbol

Modulation Type: 8QAM

Chromatic Dispersion 0 ps/nm

Configured CD-MIN -48000 ps/nm CD-MAX 48000 ps/nm

Polarization Mode Dispersion = 0.0 ps

Second Order Polarization Mode Dispersion = 29.00 ps^2

Optical Signal to Noise Ratio = 36.10 dB

SNR = 17.50 dB

Polarization Dependent Loss = 0.50 dB

Polarization Change Rate = 0.00 rad/s

Differential Group Delay = 1.00 ps

Transceiver Vendor Details

Form Factor                    : CFP2  
Name                            : CISCO-ACACIA  
Part Number                    : 10-3500-01  
Rev Number                    : 01  
Serial Number                   : ACA24480037  
PID                             : ONS-CFP2D-400G-C

```

VID                               : VES1
Date Code(yy/mm/dd)              : 20/11/10
Fiber Connector Type: LC
Otn Application Code: Not Set
Sonet Application Code: Not Set
Ethernet Compliance Code: Not set

```

```
Transceiver Temperature : 46 Celsius
```

```

AINS Soak                        : None
AINS Timer                       : 0h, 0m
AINS remaining time              : 0 seconds

```

## Optical Signal to Noise Ratio

You can configure the minimum acceptable Optical Signal to Noise ratio (OSNR) value. The OSNR alarm is raised if OSNR goes below this value.

The range is 0–4000 (in units of 0.01db).

To configure the minimum acceptable OSNR, use the following command:

**configure**

**controller optics** *R/S/I/P*

**osnr-low-threshold** *osnr-value*

**commit**

The following sample configures the minimum acceptable OSNR on the controller optics:

```

RP/0/RP0/CPU0:ios#configure
RP/0/RP0/CPU0:ios(config)#controller optics 0/0/0/12
RP/0/RP0/CPU0:ios(config-Optics)#osnr-low-threshold 40
RP/0/RP0/CPU0:ios(config-Optics)#commit

```

The following sample shows the minimum acceptable OSNR configured on the controller optics:

```

RP/0/RP0/CPU0:ios#show controllers optics 0/0/0/12
Fri Nov 12 10:58:50.595 UTC

Controller State: Up

Transport Admin State: In Service

Laser State: On

LED State: Yellow

Optics Status

Optics Type: CFP2 DWDM
DWDM carrier Info: C BAND, MSA ITU Channel=61, Frequency=193.10THz,
Wavelength=1552.524nm

Alarm Status:
-----
Detected Alarms:
    HIGH-RX-PWR    LOW-TX-PWR
    HIGH-DGD

```

LOS/LOL/Fault Status:

Alarm Statistics:

```

-----
HIGH-RX-PWR = 1          LOW-RX-PWR = 0
HIGH-TX-PWR = 0          LOW-TX-PWR = 1
HIGH-LBC = 0            HIGH-DGD = 6
OOR-CD = 0              OSNR = 0
WVL-OOL = 0            MEA = 0
IMPROPER-REM = 1
TX-POWER-PROV-MISMATCH = 0
Laser Bias Current = 0.0 %
Actual TX Power = 0.97 dBm
RX Power = -0.53 dBm
RX Signal Power = -1.20 dBm
Frequency Offset = 63 MHz

```

Performance Monitoring: Enable

THRESHOLD VALUES

```

-----

```

Parameter	High Alarm	Low Alarm	High Warning	Low Warning
Rx Power Threshold(dBm)	-2.0	-3.0	0.0	0.0
Tx Power Threshold(dBm)	4.0	2.0	0.0	0.0
LBC Threshold(mA)	N/A	N/A	0.00	0.00

```

-----

```

```

LBC High Threshold = 55 %
Configured Tx Power = 1.00 dBm
Configured CD High Threshold = 2400 ps/nm
Configured CD lower Threshold = -2400 ps/nm
Configured OSNR lower Threshold = 0.40 dB
Configured DGD Higher Threshold = 0.30 ps
Baud Rate = 63.1394679230 GBd
Bits per Symbol = 3.0000000000 bits/symbol
Modulation Type: 8QAM
Chromatic Dispersion 0 ps/nm
Configured CD-MIN -48000 ps/nm CD-MAX 48000 ps/nm
Polarization Mode Dispersion = 0.0 ps
Second Order Polarization Mode Dispersion = 29.00 ps^2
Optical Signal to Noise Ratio = 36.10 dB
SNR = 17.50 dB
Polarization Dependent Loss = 0.50 dB
Polarization Change Rate = 0.00 rad/s
Differential Group Delay = 1.00 ps

```

Transceiver Vendor Details

```

Form Factor      : CFP2
Name             : CISCO-ACACIA
Part Number      : 10-3500-01
Rev Number       : 01
Serial Number    : ACA24480037
PID              : ONS-CFP2D-400G-C
VID              : VES1
Date Code(yy/mm/dd) : 20/11/10
Fiber Connector Type: LC
Otn Application Code: Not Set
Sonet Application Code: Not Set
Ethernet Compliance Code: Not set

```

```
Transceiver Temperature : 46 Celsius
```

```
AINS Soak           : None
AINS Timer          : 0h, 0m
AINS remaining time : 0 seconds
```

## Chromatic Dispersion Threshold

You can configure the minimum and maximum acceptable chromatic dispersion for the trunk optics controllers. The CD alarm is raised if the chromatic dispersion goes below the minimum or exceeds the maximum value.

The following is a sample of configuring the minimum and maximum chromatic dispersion threshold:

To configure the maximum and minimum acceptable CD, use the following command:

### configure

**controller optics** *R/S/I/P*

**cd-high-threshold** *cd-high*

**cd-low-threshold** *cd-low*

### commit

The following sample configures the maximum and minimum acceptable CD on the controller optics:

```
RP/0/RP0/CPU0:ios#configure
RP/0/RP0/CPU0:ios(config)#controller optics 0/0/0/12
RP/0/RP0/CPU0:ios(config-Optics)#cd-high-threshold 2400
RP/0/RP0/CPU0:ios(config-Optics)#cd-low-threshold -2400
RP/0/RP0/CPU0:ios(config-Optics)#commit
```

The following sample shows the maximum and minimum acceptable CD configured on the controller optics:

```
RP/0/RP0/CPU0:ios#show controllers optics 0/0/0/12
Fri Nov 12 10:58:50.595 UTC

Controller State: Up

Transport Admin State: In Service

Laser State: On

LED State: Yellow

Optics Status

  Optics Type: CFP2 DWDM
  DWDM carrier Info: C BAND, MSA ITU Channel=61, Frequency=193.10THz,
  Wavelength=1552.524nm

  Alarm Status:
  -----
  Detected Alarms:
                HIGH-RX-PWR    LOW-TX-PWR
                HIGH-DGD

  LOS/LOL/Fault Status:

  Alarm Statistics:
```

```

-----
HIGH-RX-PWR = 1          LOW-RX-PWR = 0
HIGH-TX-PWR = 0          LOW-TX-PWR = 1
HIGH-LBC = 0            HIGH-DGD = 6
OOR-CD = 0              OSNR = 0
WVL-OOL = 0             MEA = 0
IMPROPER-REM = 1
TX-POWER-PROV-MISMATCH = 0
Laser Bias Current = 0.0 %
Actual TX Power = 0.97 dBm
RX Power = -0.53 dBm
RX Signal Power = -1.20 dBm
Frequency Offset = 63 MHz

```

Performance Monitoring: Enable

THRESHOLD VALUES

-----

Parameter	High Alarm	Low Alarm	High Warning	Low Warning
Rx Power Threshold(dBm)	-2.0	-3.0	0.0	0.0
Tx Power Threshold(dBm)	4.0	2.0	0.0	0.0
LBC Threshold(mA)	N/A	N/A	0.00	0.00

```

LBC High Threshold = 55 %
Configured Tx Power = 1.00 dBm
Configured CD High Threshold = 2400 ps/nm
Configured CD lower Threshold = -2400 ps/nm
Configured OSNR lower Threshold = 0.40 dB
Configured DGD Higher Threshold = 0.30 ps
Baud Rate = 63.1394679230 GBd
Bits per Symbol = 3.0000000000 bits/symbol
Modulation Type: 8QAM
Chromatic Dispersion 0 ps/nm
Configured CD-MIN -48000 ps/nm CD-MAX 48000 ps/nm
Polarization Mode Dispersion = 0.0 ps
Second Order Polarization Mode Dispersion = 29.00 ps^2
Optical Signal to Noise Ratio = 36.10 dB
SNR = 17.50 dB
Polarization Dependent Loss = 0.50 dB
Polarization Change Rate = 0.00 rad/s
Differential Group Delay = 1.00 ps

```

Transceiver Vendor Details

```

Form Factor      : CFP2
Name             : CISCO-ACACIA
Part Number      : 10-3500-01
Rev Number       : 01
Serial Number    : ACA24480037
PID              : ONS-CFP2D-400G-C
VID              : VES1
Date Code(yy/mm/dd) : 20/11/10
Fiber Connector Type: LC
Otn Application Code: Not Set
Sonet Application Code: Not Set
Ethernet Compliance Code: Not set

```

Transceiver Temperature : 46 Celsius

```
AINS Soak           : None
AINS Timer         : 0h, 0m
AINS remaining time : 0 seconds
```

## Receive Power Threshold

You can configure the high and low threshold of the total optical signal power of the received signal on the trunk optics controller.

The range is -400 to 300 (in the units of 0.1 dBm).

To configure the high and low receive power threshold, use the following command:

### **configure**

**controller optics** *R/S/I/P*

**rx-high-threshold** *rx-high*

**rx-low-threshold** *rx-low*

### **commit**

The following sample configures the high receive power threshold on the controller optics:

```
RP/0/RP0/CPU0:ios#configure
RP/0/RP0/CPU0:ios(config)#controller optics 0/0/0/12
RP/0/RP0/CPU0:ios(config-Optics)#rx-high-threshold -20
RP/0/RP0/CPU0:ios(config-Optics)#rx-low-threshold -30
RP/0/RP0/CPU0:ios(config-Optics)#commit
```

The following sample shows the high receive power threshold configured on the controller optics:

```
RP/0/RP0/CPU0:ios#show controllers optics 0/0/0/12
Fri Nov 12 10:58:50.595 UTC

Controller State: Up

Transport Admin State: In Service

Laser State: On

LED State: Yellow

Optics Status

    Optics Type: CFP2 DWDM
    DWDM carrier Info: C BAND, MSA ITU Channel=61, Frequency=193.10THz,
    Wavelength=1552.524nm

    Alarm Status:
    -----
    Detected Alarms:
                HIGH-RX-PWR   LOW-TX-PWR
                HIGH-DGD

    LOS/LOL/Fault Status:

    Alarm Statistics:
    -----
    HIGH-RX-PWR = 1           LOW-RX-PWR = 0
    HIGH-TX-PWR = 0           LOW-TX-PWR = 1
```

```

HIGH-LBC = 0                HIGH-DGD = 6
OOR-CD = 0                  OSNR = 0
WVL-OOL = 0                 MEA = 0
IMPROPER-REM = 1
TX-POWER-PROV-MISMATCH = 0
Laser Bias Current = 0.0 %
Actual TX Power = 0.97 dBm
RX Power = -0.53 dBm
RX Signal Power = -1.20 dBm
Frequency Offset = 63 MHz

```

Performance Monitoring: Enable

THRESHOLD VALUES

-----

Parameter	High Alarm	Low Alarm	High Warning	Low Warning
<b>Rx Power Threshold(dBm)</b>	<b>-2.0</b>	<b>-3.0</b>	<b>0.0</b>	<b>0.0</b>
Tx Power Threshold(dBm)	4.0	2.0	0.0	0.0
LBC Threshold(mA)	N/A	N/A	0.00	0.00

```

LBC High Threshold = 55 %
Configured Tx Power = 1.00 dBm
Configured CD High Threshold = 2400 ps/nm
Configured CD lower Threshold = -2400 ps/nm
Configured OSNR lower Threshold = 0.40 dB
Configured DGD Higher Threshold = 0.30 ps
Baud Rate = 63.1394679230 Gbd
Bits per Symbol = 3.0000000000 bits/symbol
Modulation Type: 8QAM
Chromatic Dispersion 0 ps/nm
Configured CD-MIN -48000 ps/nm CD-MAX 48000 ps/nm
Polarization Mode Dispersion = 0.0 ps
Second Order Polarization Mode Dispersion = 29.00 ps^2
Optical Signal to Noise Ratio = 36.10 dB
SNR = 17.50 dB
Polarization Dependent Loss = 0.50 dB
Polarization Change Rate = 0.00 rad/s
Differential Group Delay = 1.00 ps

```

Transceiver Vendor Details

```

Form Factor      : CFP2
Name             : CISCO-ACACIA
Part Number      : 10-3500-01
Rev Number       : 01
Serial Number    : ACA24480037
PID              : ONS-CFP2D-400G-C
VID              : VES1
Date Code (yy/mm/dd) : 20/11/10
Fiber Connector Type: LC
Otn Application Code: Not Set
Sonet Application Code: Not Set
Ethernet Compliance Code: Not set

```

Transceiver Temperature : 46 Celsius

```

AINS Soak      : None
AINS Timer     : 0h, 0m
AINS remaining time : 0 seconds

```



# Transmit Power Threshold

You can configure the high and low threshold of the total optical signal power of the transmitted signal on the trunk optics controller.

The range is -400 to 300 (in the units of 0.1 dBm).

To configure the high and low transmit power threshold, use the following command:

## configure

**controller optics** *R/S/I/P*

**tx-high-threshold** *tx-high*

**tx-low-threshold** *tx-low*

## commit

The following sample configures the high transmit power threshold on the controller optics:

```
RP/0/RP0/CPU0:ios#configure
RP/0/RP0/CPU0:ios(config)#controller optics 0/0/0/12
RP/0/RP0/CPU0:ios(config-Optics)#tx-high-threshold 40
RP/0/RP0/CPU0:ios(config-Optics)#tx-low-threshold 20
RP/0/RP0/CPU0:ios(config-Optics)#commit
```

The following sample shows the high transmit power threshold configured on the controller optics:

```
RP/0/RP0/CPU0:ios#show controllers optics 0/0/0/12
Fri Nov 12 10:58:50.595 UTC

Controller State: Up

Transport Admin State: In Service

Laser State: On

LED State: Yellow

Optics Status

    Optics Type: CFP2 DWDM
    DWDM carrier Info: C BAND, MSA ITU Channel=61, Frequency=193.10THz,
    Wavelength=1552.524nm

    Alarm Status:
    -----
    Detected Alarms:
                HIGH-RX-PWR   LOW-TX-PWR
                HIGH-DGD

    LOS/LOL/Fault Status:

    Alarm Statistics:

    -----
    HIGH-RX-PWR = 1           LOW-RX-PWR = 0
    HIGH-TX-PWR = 0           LOW-TX-PWR = 1
    HIGH-LBC = 0             HIGH-DGD = 6
    OOR-CD = 0               OSNR = 0
    WV-LOOL = 0             MEA = 0
    IMPROPER-REM = 1
```

```

TX-POWER-PROV-MISMATCH = 0
Laser Bias Current = 0.0 %
Actual TX Power = 0.97 dBm
RX Power = -0.53 dBm
RX Signal Power = -1.20 dBm
Frequency Offset = 63 MHz

```

Performance Monitoring: Enable

THRESHOLD VALUES

-----

Parameter	High Alarm	Low Alarm	High Warning	Low Warning
Rx Power Threshold(dBm)	-2.0	-3.0	0.0	0.0
<b>Tx Power Threshold(dBm)</b>	<b>4.0</b>	<b>2.0</b>	<b>0.0</b>	<b>0.0</b>
LBC Threshold(mA)	N/A	N/A	0.00	0.00

```

LBC High Threshold = 55 %
Configured Tx Power = 1.00 dBm
Configured CD High Threshold = 2400 ps/nm
Configured CD lower Threshold = -2400 ps/nm
Configured OSNR lower Threshold = 0.40 dB
Configured DGD Higher Threshold = 0.30 ps
Baud Rate = 63.1394679230 GBd
Bits per Symbol = 3.0000000000 bits/symbol
Modulation Type: 8QAM
Chromatic Dispersion 0 ps/nm
Configured CD-MIN -48000 ps/nm CD-MAX 48000 ps/nm
Polarization Mode Dispersion = 0.0 ps
Second Order Polarization Mode Dispersion = 29.00 ps^2
Optical Signal to Noise Ratio = 36.10 dB
SNR = 17.50 dB
Polarization Dependent Loss = 0.50 dB
Polarization Change Rate = 0.00 rad/s
Differential Group Delay = 1.00 ps

```

Transceiver Vendor Details

```

Form Factor          : CFP2
Name                 : CISCO-ACACIA
Part Number          : 10-3500-01
Rev Number           : 01
Serial Number        : ACA24480037
PID                  : ONS-CFP2D-400G-C
VID                  : VES1
Date Code(yy/mm/dd) : 20/11/10
Fiber Connector Type: LC
Otn Application Code: Not Set
Sonet Application Code: Not Set
Ethernet Compliance Code: Not set

```

Transceiver Temperature : 46 Celsius

```

AINS Soak           : None
AINS Timer          : 0h, 0m
AINS remaining time : 0 seconds

```

# Frequency

You can configure the frequency on trunk ports of the line card.

The following table lists the frequency range with grid spacing supported on the line card:

Line Card	Frequency Range (THz)	Default Frequency (THz)	Grid Spacing
1.2T	191.25 to 196.1	193.1	50GHz and 100MHz
1.2TL <a href="#">1</a>	186.1 to 190.85	188.5	100MHz
OTN-XP CFP2 trunk	191.275 to 196.125	193.1	50GHz and 100MHz
OTN-XP QDD ZRP	191.275 to 196.125	193.70	6.25GHz, 50GHz, and 100MHz
2-QDD-C	191.15 to 196.1	193.1	50GHz and 100MHz

<sup>1</sup> Only non-ITU channels are supported

To configure the wavelength, use the following commands:

```
configure
```

```
controller optics Rack/Slot/Instance/Port
```

```
dwdm-carrier {100MHz-grid frequency frequency} | {50GHz-grid [frequency frequency]}
```

```
commit
```

## Pseudo Random Binary Sequence

Table 21: Feature History

Feature Name	Release Information	Feature Description
PRBS (Pseudo Random Binary Sequence) on ODU4	Cisco IOS XR Release 7.3.1	1.2T card supports PRBS on the ODU4 controller. This feature allows you to test whether the traffic is error free during link bring up without depending on the peer port.

The Pseudo Random Binary Sequence (PRBS) feature allows you to perform data integrity checks between the NCS1004 trunk links without enabling the actual client traffic.

You need to enable PRBS feature on both the transmitting and receiving NCS 1004 trunk ports. The transmitting trunk port generates a bit pattern and sends it to the peer NCS 1004 device. The device detects if the sent bit pattern is received.

From R7.3.1 onwards, you can configure PRBS on the NCS 1004 trunk port for the 2-QDD-C card.

You can configure NCS 1004 trunk port in any one of the following modes for PRBS on the 1.2T card:

- **Source mode** — The NCS 1004 at trunk port generates PRBS signal on the line continuously as per the configured PRBS pattern.
- **Sink mode** — The NCS 1004 at trunk port gets locked to the ingress signal according to the configured pattern, analyzes and reports the errors.
- **Source-Sink mode** — The NCS 1004 at trunk port acts as both the PRBS transmitter and receiver, that is, it generates PRBS signal as per the configured pattern, and also gets locked to the ingress signal with the same pattern, and reports the errors.



---

**Note** From R7.3.1 onwards, the 1.2T card supports PRBS on ODU4.

---

NCS 1004 trunk port supports the following PRBS patterns:

- **PRBS31** — Sequence length is from  $2^{31} - 1$  bits.
- **PRBS23** — Sequence length is from  $2^{23} - 1$  bits.
- **PRBS15** — Sequence length is from  $2^{15} - 1$  bits.
- **PRBS7** — Sequence length is from  $2^7 - 1$  bits.

#### Limitations of PRBS

There are following limitations with the PRBS feature:

- There is no SNMP support to fetch the PRBS status or Performance Monitoring (PM).
- TTI functionality is not supported with PRBS.
- Loopback and PRBS configurations cannot coexist on a coherent DSP controller. Loopback configuration will be rejected if PRBS is already configured.
- PRBS on ODU4 is supported only when the slice is provisioned in OTN client mode.

#### PRBS on OTN-XP Card

From R7.2.1 onwards, the OTN-XP card supports PRBS on the mapper optical data unit (ODU2e).



---

**Note** ODU2e PRBS is not supported for OTU2E client rates.

---

NCS 1004 with the OTN-XP card, supports the following PRBS mode:

- **Source mode** — The NCS 1004 at trunk port generates PRBS signal on the line continuously as per the configured PRBS pattern.
- **Sink mode** — The NCS 1004 at trunk port gets locked to the ingress signal according to the configured pattern, analyzes and reports the errors.

- **Source-Sink mode** — The NCS 1004 at trunk port acts as both the PRBS transmitter and receiver, that is, it generates PRBS signal as per the configured pattern, and also gets locked to the ingress signal with the same pattern, and reports the errors.
- **invertedpn31** — Inverted pattern. Sequence length is from  $2^{31} - 1$  bits.

NCS 1004 trunk port supports the following PRBS patterns:

- **PRBS31** — Sequence length is from  $2^{31} - 1$  bits.
- **PRBS23** — Sequence length is from  $2^{23} - 1$  bits.
- **PRBS15** — Sequence length is from  $2^{15} - 1$  bits.
- **PRBS7** — Sequence length is from  $2^7 - 1$  bits.

## Configuring Pseudo Random Binary Sequence

The secondary admin state of the coherentDSP or ODU4 controller must be set to maintenance before enabling PRBS.

To enable the PRBS on the trunk port, use the following configuration command at the coherentDSP controller:

```
controller coherentDSP R/S/I/P prbs mode {source | sink | source-sink} pattern {pn31 | pn23 | pn15 | pn7}
```

To enable the PRBS on the trunk port, use the following configuration command at the ODU4 controller:

```
controller odu4 R/S/I/P/L opu prbs mode {source | sink | source-sink} pattern {pn31 | pn23 | pn15 | pn7}
```

When the PRBS is enabled on the trunk ports, you can view the following impacts in the corresponding client ports:

- Client traffic is dropped in the direction of source to sink as the frames are overwritten by the PRBS pattern.
- Remote fault is raised on the client ports nearer to the PRBS sink.

The following are the ODU4 PRBS combinations. The client ports must have physical loop back in all the combinations.

- Near End client and Near End trunk ODU4
- Near End client and Far End client ODU4
- Near End client and Far End trunk ODU4
- Near End trunk and Far End trunk ODU4

The following sample diagram describes the ODU4 PRBS combination for Near End client and Near End trunk.



## Verifying PRBS

You can monitor the status of Pseudo Random Binary Sequence (PRBS) on the CoherentDSP or ODU4 controller using the following command:

### show controllers coherentDSP | ODU4 R/S/I/P prbs-details

```
RP/0/RP0/CPU0:ios#show controllers coherentDSP 0/1/0/0 prbs-details
Wed Nov 6 23:12:22.464 UTC
```

```
-----PRBS details-----
PRBS Test           : Enable
PRBS Mode           : Source
PRBS Pattern        : PN7
PRBS Status         : Not Applicable
```

```
RP/0/RP0/CPU0:ios#show controllers ODU4 0/3/0/8 prbs-details
Mon Jan 11 05:29:12.436 UTC
```

```
-----PRBS details-----
PRBS Test           : Enable
PRBS Mode           : Source
PRBS Pattern        : PN7
PRBS Status         : Not Applicable
```

```
RP/0/RP0/CPU0:ios#show controllers ODU4 0/3/0/1/1 prbs-details
Mon Jan 11 05:27:56.370 UTC
```

```
-----PRBS details-----
PRBS Test           : Enable
PRBS Mode           : Sink
PRBS Pattern        : PN7
PRBS Status         : Locked
```

- You cannot view any details, if the PRBS is not enabled on the trunk.
- PRBS status is shown as **Not Applicable**, when the mode is **Source**.
- PRBS status is shown as **unlocked**, when the signal is not locked on the receiving side in the **Sink** or **Source-Sink** mode.

## Viewing PRBS Performance Monitoring Parameters

PRBS PM parameters are not available for the controllers in Source mode. PRBS PM parameters are reset when PRBS configuration changes on the controller.

To view the PRBS PM parameters on the coherentDSP controller, use the following command:

```
show controllers coherentDSP | ODU4 R/S/I/P pm {current | history} {15-min|24-hour} prbs
```

The following tables describes the fields of PRBS PM parameters.

Table 22: PRBS PM Parameters

PM Parameter	Description
EBC	Cumulative count of PRBS bit errors in the sampling interval (15-minute or 24-hour). PRBS bit errors are accumulated only if PRBS signal is locked.
FOUND-COUNT	Number of state transitions from signal unlocked state to signal locked state in the sampling interval. If state change is not observed in the interval, the count is 0.
LOST-COUNT	Number of state transitions from signal locked state to signal unlocked state in the sampling interval. If state change is not observed in the interval, the count is 0.
FOUND-AT-TS	Latest timestamp when the PRBS state moves from unlocked state to locked state in the sampling interval. If state change is not observed in the interval, the value is null.
CONFIG-PTRN	Configured PRBS pattern on the port.

```
RP/0/RP0:ios#show controllers coherentDSP 0/0/0/1 pm current 15-min prbs
Mon Feb 13 00:58:48.327 UTC
```

```
PRBS in the current interval [00:45:00 - 00:58:48 Mon Feb 13 2019]
PRBS current bucket type : Valid
EBC                       : 40437528165
FOUND-COUNT               : 1 FOUND-AT-TS : 00:51:22 Mon Feb 13 2019
LOST-COUNT                : 1 LOST-AT-TS  : 00:52:52 Mon Feb 13 2019
CONFIG-PTRN              : PRBS_PATTERN_PN31
Last clearing of "show controllers OTU" counters never
```

```
RP/0/RP0:ios#show controllers ODU4 0/3/0/1/1 pm current 15-min prbs
Mon Jan 11 00:58:48.327 UTC
```

```
PRBS in the current interval [00:45:00 - 00:58:48 Mon Jan 11 2021]
PRBS current bucket type : Valid
EBC                       : 40437528165
FOUND-COUNT               : 1 FOUND-AT-TS : 00:51:22 Mon Jan 11 2021
LOST-COUNT                : 1 LOST-AT-TS  : 00:52:52 Mon Jan 11 2021
CONFIG-PTRN              : PRBS_PATTERN_PN7
Last clearing of "show controllers ODU" counters never
```

## Configuring PRBS on OTN-XP Card

To configure PRBS mode on the ODU2e controller, you must configure Optical Channel Payload Unit (OPU) on the ODU2e controller followed by the PRBS mode and the pattern. The PRBS supported pattern on the OTN-XP card is invertedPN31.

From R7.3.1 onwards, you can configure PRBS on client or mapper ODU4 and ODU flex controllers.



**Note** ODU2e PRBS is not supported for OTU2E client rates.

To configure PRBS mode on the ODU2e controller, enter the following commands:

```
configure
controller odu2e | oduflex R/S/I/P/client-port/lane-number
secondary-admin-state maintenance
opu
prbs mode {source | sink | source-sink} pattern invertedpn31 {direction {system | line}}
end
commit
```

The following example shows how to configure PRBS mode as source-sink with pattern as invertedpn31:

```
RP/0/RP0/CPU0:ios#configure
RP/0/RP0/CPU0:ios(config)#controller odu2e0/2/0/12/3/2
RP/0/RP0/CPU0:ios(config-odu2e)#secondary-admin-state maintenance
RP/0/RP0/CPU0:ios(config-odu2e)#opu
RP/0/RP0/CPU0:ios(config-Opuk)#prbs mode source-sink pattern invertedpn31
RP/0/RP0/CPU0:ios(config-Opuk)#end
RP/0/RP0/CPU0:ios(config-odu2e)#commit
```

The following is a sample output of **show controller odu2e** command.

```
RP/0/RP0/CPU0(config-odu2e)#show controller odu2e 0/2/0/12/3/2 prbs-details
Mon Mar 14 21:33:02.293 UTC

-----PRBS details-----
PRBS Test                : Enable
PRBS Mode                : Source-Sink
PRBS Pattern             : INVERTED PN31
PRBS Status              : Locked
PRBS Lock Time(in seconds) : 1190
PRBS Bit Errors          : 0
-----
```

The following example shows how to configure PRBS mode as source-sink with pattern as invertedpn31 with direction as system:

```
RP/0/RP0/CPU0:ios#configure
Wed Nov 11 00:38:11.789 UTC
RP/0/RP0/CPU0:ios(config)#controller odu4 0/2/0/5
RP/0/RP0/CPU0:ios(config-odu4)#secondary-admin-state maintenance
RP/0/RP0/CPU0:ios(config-odu4)#opu prbs mode source-sink pattern invertedpn31 direction
system
RP/0/RP0/CPU0:ios(config-odu4)#commit
Wed Nov 11 00:38:26.391 UTC
```

The following example shows how to configure PRBS mode as source-sink with pattern as invertedpn31 with direction as line:

```
RP/0/RP0/CPU0:ios#configure
Wed Nov 11 00:38:11.789 UTC
RP/0/RP0/CPU0:ios(config)#controller odu4 0/2/0/5
RP/0/RP0/CPU0:ios(config-odu4)#secondary-admin-state maintenance
RP/0/RP0/CPU0:ios(config-odu4)#opu prbs mode source-sink pattern invertedpn31 direction
line
```



```
RP/0/RP0/CPU0:ios(config-odu4)#commit
Wed Nov 11 00:38:26.391 UTC
```

The following example shows how to configure PRBS on the mapper controller:

```
RP/0/RP0/CPU0:ios#configure
Thu Oct 7 13:17:27.267 UTC
RP/0/RP0/CPU0:ios(config)#controller odu4 0/2/0/13/8
RP/0/RP0/CPU0:ios(config-odu4)#secondary-admin-state maintenance
RP/0/RP0/CPU0:ios(config-odu4)#opu prbs mode source-sink pattern invertedpn31
RP/0/RP0/CPU0:ios(config-odu4)#commit
```

The following example shows how to configure PRBS on the mapper controller with PRBS mode as source-sink and pattern as invertedpn31 with direction as line:

```
RP/0/RP0/CPU0:ios(config)#controller odu4 0/3/0/7
RP/0/RP0/CPU0:ios(config-odu4)#secondary-admin-state maintenance
RP/0/RP0/CPU0:ios(config-odu4)#opu prbs mode source-sink pattern invertedpn31 direction
line
RP/0/RP0/CPU0:ios(config-odu4)#commit
Tue Oct 12 13:17:07.840 UTC
```

## Verifying PRBS on OTN-XP Card

You can monitor the status of PRBS on the ODU2e controller using the following command:

**show controllers odu2e R/S/I/P/client-port/client-lane prbs-details**

The following example displays the output of the PRBS configuration with PRBS mode as sink:

```
RP/0/RP0/CPU0:ios#show controllers odu2e 0/2/0/12/3/2 prbs-details
-----PRBS details-----
PRBS Test           : Enable
PRBS Mode           : Sink
PRBS Pattern        : INVERTED PN31
PRBS Status         : Locked
```

The following example displays the output of the PRBS configuration with PRBS mode as source-sink:

```
RP/0/RP0/CPU0:ios#show controllers odu2e 0/2/0/12/3/2 prbs-details
-----PRBS details-----
PRBS Test           : Enable
PRBS Mode           : Source-Sink
PRBS Pattern        : INVERTED PN31
PRBS Status         : Locked
```

The following example displays the output of the PRBS configuration on the mapper controller:

```
RP/0/RP0/CPU0:ios#show controllers odu4 0/2/0/13/8 prbs-details
Thu Oct 7 13:21:19.444 UTC

-----PRBS details-----
PRBS Test : Enable
PRBS Mode : Source-Sink
PRBS Pattern : INVERTED PN31
PRBS Status : Locked

-----
```

The following example displays the output of the PRBS configuration on the mapper controller with PRBS mode as source-sink and pattern as invertedpn31 with direction as line:

```
RP/0/RP0/CPU0:ios#show controllers odu4 0/3/0/7 prbs-details Tue Oct 12 13:17:22.748 UTC
Tue Oct 12 13:17:22.748 UTC
-----PRBS details-----
PRBS Test : Enable
PRBS Mode : Source-Sink
PRBS Pattern : INVERTED PN31
PRBS Status : Unlocked
PRBS Direction : Line
PRBS Bit Errors : 0
-----
```

## Clearing Bit Errors and Lock Time for PRBS

Lock time is the time that is elapsed since the last PRBS lock is detected.

The following sample shows that bit errors are observed during the PRBS test:

```
RP/0/RP0/CPU0:ios#show controllers odu4 0/2/0/5 prbs-details
Fri Nov 13 03:21:44.191 UTC
-----PRBS details-----
PRBS Test : Enable
PRBS Mode : Source-Sink
PRBS Pattern : INVERTED PN31
PRBS Status : Locked
PRBS Direction : Line
PRBS Lock Time(in seconds) : 28
PRBS Bit Errors : 23776
-----
```

To clear the lock time and bit errors before the PRBS test, use the **clear** command:

```
RP/0/RP0/CPU0:ios#clear controller odu4 0/2/0/5 prbs-details
Fri Nov 13 03:21:50.726 UTC
PRBS bit errors cleared
```

The following sample displays the bit errors and lock time are removed.

```
RP/0/RP0/CPU0:ios#show controllers odu4 0/2/0/5 prbs-details
Fri Nov 14 03:21:44.191 UTC
-----PRBS details-----
PRBS Test : Enable
PRBS Mode : Source-Sink
PRBS Pattern : INVERTED PN31
PRBS Status : Locked
PRBS Direction : Line
PRBS Lock Time(in seconds) : 2
PRBS Bit Errors : 0
```

## FlexO GID and IID

In the 4x100G-MXP-400G-TXP LC mode, the OTN-XP card uses flexible OTN (flexO) interfaces on trunk ports. These flexO interfaces provide a flexible and interoperable mechanism to transport OTUCn signals by grouping standard lower rate interfaces. Each flexO interface group is identified by a flexO group identification (GID) number, which ranges 1–1,048,576. Each member of a flexO group is identified by a flexO instance identification (IID) number, which ranges 1–254.

From Release 7.3.1 onwards, flexO GID and IID configurations are supported on CoherentDSP controller for the OTN-XP card.

## Configuring FlexO GID and IID

To configure flexO GID and IID on the coherentDSP controller, enter the following commands:

```
configure
controller coherentDSP R/S/I/P
flexo
gid <gid-no> iid <iid-no>
commit
```



**Note** You must configure the iid number based on the trunk bandwidth. You must add 1, 2, 3, and 4 iid numbers for 100G, 200G, 300G, and 400G respectively.

The following sample shows how to configure flexO GID and IID on the CoherentDSP controller:

```
RP/0/RP0/CPU0:ios#configure
RP/0/RP0/CPU0:ios(config)#controller coherentDSP0/2/0/12
RP/0/RP0/CPU0:ios(config-CoDSP)#flexo
RP/0/RP0/CPU0:ios(config-CoDSP)#gid 2 iid 5,6,7,8
RP/0/RP0/CPU0:ios(config-CoDSP)#commit
```

## Verifying FlexO GID and IID

The following sample shows the flexO GID and IID configuration on the CoherentDSP controller:

```
RP/0/RP0/CPU0:ios#show controllers coherentDSP 0/2/0/12

Tue Jan 12 11:26:08.235 UTC
Port : CoherentDSP 0/2/0/12
Controller State : Up
Inherited Secondary State : Normal
Configured Secondary State : Normal
Derived State : In Service
Loopback mode : None
BER Thresholds : SF = 1.0E-5 SD = 1.0E-7
Performance Monitoring : Enable
Bandwidth : 400.0Gb/s
```

```

Alarm Information:
LOS = 0 LOF = 3 LOM = 0
OOF = 3 OOM = 0 AIS = 0
IAE = 0 BIAE = 0 SF_BER = 0
SD_BER = 0 BDI = 0 TIM = 0
FECMISMATCH = 0 FEC-UNC = 0 FLEXO_GIDM = 1
FLEXO-MM = 1 FLEXO-LOM = 0 FLEXO-RDI = 3
FLEXO-LOF = 0
Detected Alarms : None

Bit Error Rate Information
PREFEC BER : 6.43E-04
POSTFEC BER : 0.00E+00

TTI :
Remote hostname : ios
Remote interface : CoherentDSP 0/0/0/13
Remote IP addr : 0.0.0.0

FEC mode : O_FEC

Flexo-Mode : Enable
Flexo Details:
Tx GID : 2
TX IID : 5,6,7,8,
Rx GID : 2
RX IID 5,6,7,8,

AINS Soak : None
AINS Timer : 0h, 0m
AINS remaining time : 0 seconds

```

## Flexo Parameter Update on Inverse Muxponder Configuration on the OTN-XP Card

By default, the value of flexo parameters for the coherentDSP controllers in the 400G inverse muxponder, are as follows:

- CoherentDSP 0/0/0/12—GID is 1 and IID is 1, 2.
- CoherentDSP 0/0/0/13—GID is 1 IID is 3, 4.

The following example displays the default configurations on the transmission side:

```

RP/0/RP0/CPU0:ios#show controllers coherentDSP 0/0/0/13
Wed Jun  9 23:17:30.794 UTC

Port                               : CoherentDSP 0/0/0/13
Controller State                    : Admin Down
Inherited Secondary State          : Normal
Configured Secondary State        : Normal
Derived State                       : Out Of Service
Loopback mode                      : None
BER Thresholds                     : SF = 1.0E-5  SD = 1.0E-7
Performance Monitoring             : Enable
Bandwidth                          : 200.0Gb/s

Alarm Information:
LOS = 0 LOF = 0 LOM = 0
OOF = 0 OOM = 0 AIS = 0

```

```

IAE = 0 BIAE = 0          SF_BER = 0
SD_BER = 0          BDI = 0 TIM = 0
FECMISMATCH = 0 FEC-UNC = 0    FLEXO_GIDM = 0
FLEXO-MM = 0    FLEXO-LOM = 0    FLEXO-RDI = 0
FLEXO-LOF = 0
Detected Alarms                          : None

Bit Error Rate Information
PREFEC BER                               : 0.00E+00
POSTFEC BER                              : 0.00E+00
Q-Factor                                 : 0.00 dB

Q-Margin                                  : 0.00dB

TTI :
    Remote IP addr                        : 0.0.0.0

FEC mode                                  : O_FEC

Flexo-Mode                                : Enable
Flexo Details:
    Tx GID                                : 1
    TX IID                                : 3, 4,
    Rx GID                                : 0
    RX IID                                : 0, 0,

Flexo Peers Information:
    Controller                             : CoherentDSP0_0_0_12
    OTUCn rate                             : OTUC2

AINS Soak                                 : None
AINS Timer                                : 0h, 0m
AINS remaining time                       : 0 seconds

```

For 400G inverse muxponder, the flexo configuration on these coherent DSP controllers must be such that GID is the same on coherentDSP controllers on both port 12 and port 13, and IIDs are in the incremental order. In case if one of the node configurations is invalid, the Provisioning Failed alarm is raised on that particular controller. The Provisioning Failed alarm moves to the slice level in case you perform a line card reload.

The following sample configures the same IID on the coherentDSP 0/0/0/12 as that of coherentDSP 0/0/0/13 and shows the resulting Provisioning Failed alarm.

```

RP/0/RP0/CPU0:ios#configure
Wed Jun  9 23:19:28.101 UTC
RP/0/RP0/CPU0:ios(config)#controller coherentDSP 0/0/0/12
RP/0/RP0/CPU0:ios(config-CoDSP)#flexo gid 1 iid 3,4
RP/0/RP0/CPU0:ios(config-CoDSP)#commit
Wed Jun  9 23:20:08.971 UTC
RP/0/RP0/CPU0:ios(config-CoDSP)#end
RP/0/RP0/CPU0:ios#show alarms brief system active
Wed Jun  9 23:20:11.940 UTC

```

-----  
Active Alarms  
-----

Location	Severity	Group	Set Time	Description
----------	----------	-------	----------	-------------

-----

```
0/0      Major Controller 06/09/202123:20:10 UTC CoherentDSP0/0/0/12-Provisioning Failed
```

The following sample configures incremental IIDs in the coherentDSP 0/0/0/12 and coherent DSP 0/0/0/13 and verifies that the Provisioning Failed alarms cleared:

```
RP/0/RP0/CPU0:ios(config)#controller coherentDSP 0/0/0/12
RP/0/RP0/CPU0:ios(config-CoDSP)#flexo gid 1 iid 5,6
RP/0/RP0/CPU0:ios(config-CoDSP)#controller coherentDSP 0/0/0/13
RP/0/RP0/CPU0:ios(config-CoDSP)#flexo gid 1 iid 7,8
RP/0/RP0/CPU0:ios(config-CoDSP)#commit
Wed Jun  9 23:21:06.335 UTC
RP/0/RP0/CPU0:ios(config-CoDSP)#end
```

The following sample verifies the IID configurations in the coherentDSP 0/0/0/12 and coherentDSP 0/0/0/13:

```
RP/0/RP0/CPU0:ios#show controllers coherentDSP 0/0/0/12
Wed Jun  9 23:21:15.321 UTC

Port                               : CoherentDSP 0/0/0/12
Controller State                   : Admin Down
Inherited Secondary State         : Normal
Configured Secondary State       : Normal
Derived State                      : Out Of Service
Loopback mode                     : None
BER Thresholds                   : SF = 1.0E-5  SD = 1.0E-7
Performance Monitoring            : Enable
Bandwidth                         : 200.0Gb/s

Alarm Information:
LOS = 0 LOF = 0 LOM = 0
OOF = 0 OOM = 0 AIS = 0
IAE = 0 BIAE = 0          SF_BER = 0
SD_BER = 0      BDI = 0 TIM = 0
FECMISMATCH = 0 FEC-UNC = 0      FLEXO_GIDM = 0
FLEXO-MM = 0   FLEXO-LOM = 0     FLEXO-RDI = 0
FLEXO-LOF = 0
Detected Alarms                   : None

Bit Error Rate Information
PREFEC BER                        : 0.00E+00
POSTFEC BER                       : 0.00E+00
Q-Factor                          : 0.00 dB

Q-Margin                          : 0.00dB

TTI :
    Remote IP addr                 : 0.0.0.0

FEC mode                           : O_FEC

Flexo-Mode                         : Enable
Flexo Details:
    Tx GID                        : 1
    TX IID                        : 5, 6,
    Rx GID                        : 0
    RX IID                        : 0, 0,

Flexo Peers Information:
    Controller                     : CoherentDSP0_0_0_13
    OTUCn rate                     : OTUC2
```

```

AINS Soak                               : None
AINS Timer                               : 0h, 0m
AINS remaining time                       : 0 seconds

RP/0/RP0/CPU0:ios#show controllers coherentDSP 0/0/0/13
Wed Jun  9 23:21:20.348 UTC

Port                                     : CoherentDSP 0/0/0/13
Controller State                         : Admin Down
Inherited Secondary State                 : Normal
Configured Secondary State                : Normal
Derived State                             : Out Of Service
Loopback mode                             : None
BER Thresholds                           : SF = 1.0E-5  SD = 1.0E-7
Performance Monitoring                    : Enable
Bandwidth                                 : 200.0Gb/s

Alarm Information:
LOS = 0 LOF = 0 LOM = 0
OOF = 0 OOM = 0 AIS = 0
IAE = 0 BIAE = 0          SF_BER = 0
SD_BER = 0          BDI = 0 TIM = 0
FECMISMATCH = 0 FEC-UNC = 0      FLEXO_GIDM = 0
FLEXO-MM = 0      FLEXO-LOM = 0  FLEXO-RDI = 0
FLEXO-LOF = 0
Detected Alarms                           : None

Bit Error Rate Information
PREFEC BER                               : 0.00E+00
POSTFEC BER                              : 0.00E+00
Q-Factor                                  : 0.00 dB

Q-Margin                                  : 0.00dB

TTI :
      Remote IP addr                       : 0.0.0.0

FEC mode                                  : O_FEC

Flexo-Mode                                : Enable
Flexo Details:
      Tx GID                                : 1
      TX IID                                : 7, 8,
      Rx GID                                : 0
      RX IID                                : 0, 0,

Flexo Peers Information:
      Controller                             : CoherentDSP0_0_0_12
      OTUCn rate                             : OTUC2

AINS Soak                               : None
AINS Timer                               : 0h, 0m
AINS remaining time                       : 0 seconds

```

The following sample verifies that the Provisioning Failed alarm was cleared:

```
RP/0/RP0/CPU0:ios#show alarms brief system history
```

```
-----
History Alarms
-----
```

```
-----  
Location Severity Group      Set Time      Description  
Clear Time  
  
-----  
0/2      Major      Controller 09/30/2021 14:42:01 UTC CoherentDSP0/2/0/12 - Provisioning  
Failed 09/30/2021 14:42:25 UTC
```





## CHAPTER 4

# Performance Monitoring

Performance monitoring (PM) parameters are used by service providers to gather, store, set thresholds for, and report performance data for early detection of network issues. You can configure and retrieve PM counters for the various controllers in 30-second, 15-minute, or 24-hour intervals. These parameters simplify troubleshooting operations and enhance data that can be collected directly from the equipment.

- [Configuring PM Parameters, on page 151](#)

## Configuring PM Parameters

You can configure and view the performance monitoring parameters for the Optics, Ethernet, and coherent DSP controllers.

To configure PM parameters, use the following commands.

### configure

**controller** *controllertype R/S/I/P* { **pm** { **15-min** | **30-sec** | **24-hour** } { **optics** | **ether** | **pcs** | **fec** | **otn** } { **report** | **threshold** } *value* }

### commit

### Examples

The following is a sample in which the performance monitoring parameters of the Optics controller are configured at 24-hour intervals.

```
RP/0/RP0/CPU0:ios#configure
RP/0/RP0/CPU0:ios(config)#controller optics 0/0/1/5 pm 24-hour optics threshold osnr max
345
RP/0/RP0/CPU0:ios(config)#commit
```

The following is a sample in which the performance monitoring parameters of the Ethernet controller are configured at 15-minute intervals.

```
RP/0/RP0/CPU0:ios#configure
RP/0/RP0/CPU0:ios(config)#controller HundredGigEctrlr 0/3/0/0 pm 15-min pcs report bip
enable
RP/0/RP0/CPU0:ios(config)#commit
```

The following is a sample in which performance monitoring parameters of a Coherent DSP controller are configured 30-second intervals.

```
RP/0/RP0/CPU0:ios#configure
RP/0/RP0/CPU0:ios(config)#controller coherentDSP 0/0/1/1 pm 30-sec fec threshold post-fec-ber
max OE-15
RP/0/RP0/CPU0:ios(config)#commit
```

### Viewing PM Parameters

To view the performance monitoring parameters for Optics, Ethernet, and Coherent DSP controllers, use this command:

**show controllers** *controllertype R/S/L/P* { **pm** { **current** | **history** } { **30 sec** | **15-min** | **24-hour** } { **optics** | **ether** | **fec** | **otn** | **prbs** } *linenumber* }

**Example 1:** Displays the current performance monitoring parameters of the Optics controller at 15-minute intervals. Client optics have four lanes.

```
RP/0/RP0/CPU0:ios#show controller optics 0/1/0/3 pm current 15-min optics 3
Sat Feb 9 19:33:42.480 UTC

Optics in the current interval [19:30:00 - 19:33:42 Sat Feb 9 2019]

Optics current bucket type : Valid
      MIN      AVG      MAX      Operational      Configured      TCA      Operational
      Configured      TCA
      Threshold(max) (max)
      Threshold(min) Threshold(min) (min) Threshold(max)
LBC[% ]      : 0.0      0.0      0.0      0.0      NA      NO      100.0
      NA      NO
OPT[dBm]      : -40.00      -40.00      -40.00      -30.00      NA      NO      63.32
      NA      NO
OPR[dBm]      : -40.00      -40.00      -40.00      -30.00      NA      NO      63.32
      NA      NO
FREQ_OFF[Mhz]: 0      0      0      0      NA      NO      0
      NA      NO
```

**Example 2:** Displays the current performance monitoring parameters of the Optics controller 15-minute intervals. Trunk optics have one lane.

```
RP/0/RP0/CPU0:ios#show controller optics 0/2/0/1 pm current 15-min optics 1
Sat Feb 9 11:19:15.234 UTC

Optics in the current interval [11:15:00 - 11:19:15 Sat Feb 9 2019]

Optics current bucket type : Valid
      MIN      AVG      MAX      Operational      Configured      TCA      Operational
      Configured      TCA
      Threshold(max) (max)
      Threshold(min) Threshold(min) (min) Threshold(max)
LBC[% ]      : 0.0      0.0      0.0      0.0      NA      NO      100.0
      NA      NO
OPT[dBm]      : -1.51      -1.49      -1.48      -30.00      NA      NO      63.32
      NA      NO
OPR[dBm]      : -9.11      -9.07      -9.03      -30.00      NA      NO      63.32
      NA      NO
CD[ps/nm]      : 13      15      18      -180000      NA      NO      180000
      NA      NO
```

```

DGD[ps ]      : 2.00      2.33      3.00      0.01      NA      NO      21474836.46
  NA          NO
SOPMD[ps^2]   : 5.00      33.02     79.00     0.01      NA      NO      21474836.46
  NA          NO
OSNR[dB]      : 31.50     31.97     32.50     0.01      NA      NO      21474836.46
  NA          NO
PDL[dB]       : 0.20      0.34      0.50      0.01      NA      NO      21474836.46
  NA          NO
PCR[rad/s]    : 0.00      19.92     93.00     0.01      NA      NO      21474836.46
  NA          NO
RX_SIG[dBm]   : -9.05     -9.02     -8.99     -30.00    NA      NO      63.32
  NA          NO
FREQ_OFF[Mhz] : -302      -178      -74       -1500    NA      NO      1500
  NA          NO

```

**Example 3:** Displays the current performance monitoring parameters of the Ethernet controller 15-minute intervals.

```

RP/0/RP0/CPU0:ios#show controller HundredGigECtrlr 0/1/0/2 pm current 15-min ether
Fri Aug 30 00:37:53.527 UTC

```

```

ETHER in the current interval [00:30:00 - 00:37:53 Fri Aug 30 2019]

```

```

ETHER current bucket type : Valid
RX-UTIL[%]                : 100.00          Threshold : 0.00          TCA(enable) : NO
TX-UTIL[%]                : 10.00          Threshold : 0.00          TCA(enable) : NO
RX-PKT                    : 3852414442     Threshold : 0             TCA(enable) : NO
STAT-PKT                  : 0              Threshold : 0             TCA(enable) : NO
OCTET-STAT                : 5847965122956  Threshold : 0             TCA(enable) : NO
OVERSIZE-PKT              : 0              Threshold : 0             TCA(enable) : NO
FCS-ERR                   : 0              Threshold : 0             TCA(enable) : NO
LONG-FRAME                 : 0              Threshold : 0             TCA(enable) : NO
JABBER-STATS              : 0              Threshold : 0             TCA(enable) : NO
64-OCTET                  : 0              Threshold : 0             TCA(enable) : NO
65-127-OCTET              : 0              Threshold : 0             TCA(enable) : NO
128-255-OCTET             : 0              Threshold : 0             TCA(enable) : NO
256-511-OCTET             : 0              Threshold : 0             TCA(enable) : NO
512-1023-OCTET            : 0              Threshold : 0             TCA(enable) : NO
1024-1518-OCTET           : 0              Threshold : 0             TCA(enable) : NO
IN-UCAST                  : 0              Threshold : 0             TCA(enable) : NO
IN-MCAST                  : 0              Threshold : 0             TCA(enable) : NO
IN-BCAST                  : 0              Threshold : 0             TCA(enable) : NO
OUT-UCAST                 : 0              Threshold : 0             TCA(enable) : NO
OUT-BCAST                 : 0              Threshold : 0             TCA(enable) : NO
OUT-MCAST                 : 0              Threshold : 0             TCA(enable) : NO
TX-PKT                    : 7053588067     Threshold : 0             TCA(enable) : NO
OUT-OCTET                 : 451429636288   Threshold : 0             TCA(enable) : NO
IFIN-ERRORS               : 0              Threshold : 0             TCA(enable) : NO
IFIN-OCTETS               : 0              Threshold : 0             TCA(enable) : NO
STAT-MULTICAST-PKT        : 0              Threshold : 0             TCA(enable) : NO
STAT-BROADCAST-PKT        : 0              Threshold : 0             TCA(enable) : NO
STAT-UNDERSIZED-PKT      : 0              Threshold : 0             TCA(enable) : NO
IN_GOOD_BYTES             : 5847965122956  Threshold : 0             TCA(enable) : NO
IN_GOOD_PKTS              : 3852414442     Threshold : 0             TCA(enable) : NO
IN_DROP_OTHER             : 0              Threshold : 0             TCA(enable) : NO

```

```

OUT_GOOD_BYTES           : 451429636288      Threshold : 0          TCA(enable) : NO
OUT_GOOD_PKTS           : 7053588067       Threshold : 0          TCA(enable) : NO
IN_PKT_64_OCTETS        : 0               Threshold : 0          TCA(enable) : NO
IN_PKTS_65_127_OCTETS   : 0               Threshold : 0          TCA(enable) : NO
IN_PKTS_128_255_OCTETS : 0               Threshold : 0          TCA(enable) : NO
IN_PKTS_256_511_OCTETS : 0               Threshold : 0          TCA(enable) : NO
IN_PKTS_512_1023_OCTETS : 0               Threshold : 0          TCA(enable) : NO
IN_PKTS_1024_1518_OCTETS : 3852414442     Threshold : 0          TCA(enable) : NO
OUT_PKT_64_OCTETS       : 7053588067       Threshold : 0          TCA(enable) : NO
OUT_PKTS_65_127_OCTETS : 0               Threshold : 0          TCA(enable) : NO
OUT_PKTS_128_255_OCTETS : 0               Threshold : 0          TCA(enable) : NO
OUT_PKTS_256_511_OCTETS : 0               Threshold : 0          TCA(enable) : NO
OUT_PKTS_512_1023_OCTETS : 0               Threshold : 0          TCA(enable) : NO
OUT_PKTS_1024_1518_OCTETS : 0               Threshold : 0          TCA(enable) : NO
TX_UNDERSIZED_PKT       : 0               Threshold : 0          TCA(enable) : NO
TX_OVERSIZED_PKT        : 0               Threshold : 0          TCA(enable) : NO
TX_JABBER               : 0               Threshold : 0          TCA(enable) : NO
TX_BAD_FCS              : 0               Threshold : 0          TCA(enable) : NO

```



**Note** Performance monitoring statistics are not supported for IN-UCAST and OUT-UCAST counters for Ethernet clients.



**Note** If you set the LC mode on the OTN-XP card to 4x100G-MXP-400G-TXP-LC, the performance monitoring parameters for the 400GE controllers (fourHundredGigEctrlr) are unsupported in the card.

**Example 4:** Displays the current *FEC* performance monitoring parameters of the Coherent DSP controller at 15-minute intervals.

```

RP/0/RP0/CPU0:ios#show controller coherentDSP 0/2/0/1 pm current 15-min fec

Sat Feb 9 11:23:42.196 UTC

g709 FEC in the current interval [11:15:00 - 11:23:42 Sat Feb 9 2019]

FEC current bucket type : Valid
  EC-BITS      : 291612035786          Threshold : 903330          TCA(enable) :
YES
  UC-WORDS    : 0                     Threshold : 5                  TCA(enable) :
YES

          MIN      AVG      MAX      Threshold  TCA      Threshold  TCA
          (min)    (enable) (max)    (min)      (enable) (max)      (enable)
PreFEC BER : 7.1E-03  7.2E-03  8.1E-03  0E-15      NO      0E-15      NO
PostFEC BER : 0E-15   0E-15   0E-15   0E-15      NO      0E-15      NO

```

**Example 5:** Displays the current *PRBS* performance monitoring parameters of the Coherent DSP controller 15-minute intervals.

```

RP/0/RP0/CPU0:ios#show controllers coherentDSP 0/0/0/1 pm current 15-min prbs

Mon Feb 13 00:58:48.327 UTC
PRBS in the current interval [00:45:00 - 00:58:48 Mon Feb 13 2019]
PRBS current bucket type : Valid
EBC : 40437528165
FOUND-COUNT : 1 FOUND-AT-TS : 00:51:22 Mon Feb 13 2019
LOST-COUNT  : 1 LOST-AT-TS  : 00:52:52 Mon Feb 13 2019

```

```
CONFIG-PTRN : PRBS_PATTERN_PN31
Last clearing of "show controllers OTU" counters never
```

**Example 6:** Displays the current PCS performance monitoring parameters of the Coherent DSP controller 30-second intervals.

```
RP/0/RP0/CPU0:ios#show controllers hundredGigEctrlr 0/0/0/2 pm current 30-sec pcs
Tue Nov 19 09:17:26.684 UTC
```

```
Ethernet PCS in the current interval [09:17:00 - 09:17:26 Tue Nov 19 2019]
```

```
Ethernet PCS current bucket type : Valid
BIP[00] : 0 Threshold : 0 TCA(enable) : NO
BIP[01] : 0 Threshold : 0 TCA(enable) : NO
BIP[02] : 0 Threshold : 0 TCA(enable) : NO
BIP[03] : 0 Threshold : 0 TCA(enable) : NO
BIP[04] : 0 Threshold : 0 TCA(enable) : NO
BIP[05] : 0 Threshold : 0 TCA(enable) : NO
BIP[06] : 0 Threshold : 0 TCA(enable) : NO
BIP[07] : 0 Threshold : 0 TCA(enable) : NO
BIP[08] : 0 Threshold : 0 TCA(enable) : NO
BIP[09] : 0 Threshold : 0 TCA(enable) : NO
BIP[10] : 0 Threshold : 0 TCA(enable) : NO
BIP[11] : 0 Threshold : 0 TCA(enable) : NO
BIP[12] : 0 Threshold : 0 TCA(enable) : NO
BIP[13] : 0 Threshold : 0 TCA(enable) : NO
BIP[14] : 0 Threshold : 0 TCA(enable) : NO
BIP[15] : 0 Threshold : 0 TCA(enable) : NO
BIP[16] : 0 Threshold : 0 TCA(enable) : NO
BIP[17] : 0 Threshold : 0 TCA(enable) : NO
BIP[18] : 0 Threshold : 0 TCA(enable) : NO
BIP[19] : 0 Threshold : 0 TCA(enable) : NO
FRM-ERR[00] : 0 Threshold : 0 TCA(enable) : NO
FRM-ERR[01] : 0 Threshold : 0 TCA(enable) : NO
FRM-ERR[02] : 0 Threshold : 0 TCA(enable) : NO
FRM-ERR[03] : 0 Threshold : 0 TCA(enable) : NO
FRM-ERR[04] : 0 Threshold : 0 TCA(enable) : NO
FRM-ERR[05] : 0 Threshold : 0 TCA(enable) : NO
FRM-ERR[06] : 0 Threshold : 0 TCA(enable) : NO
FRM-ERR[07] : 0 Threshold : 0 TCA(enable) : NO
FRM-ERR[08] : 0 Threshold : 0 TCA(enable) : NO
FRM-ERR[09] : 0 Threshold : 0 TCA(enable) : NO
FRM-ERR[10] : 0 Threshold : 0 TCA(enable) : NO
FRM-ERR[11] : 0 Threshold : 0 TCA(enable) : NO
FRM-ERR[12] : 0 Threshold : 0 TCA(enable) : NO
FRM-ERR[13] : 0 Threshold : 0 TCA(enable) : NO
FRM-ERR[14] : 0 Threshold : 0 TCA(enable) : NO
FRM-ERR[15] : 0 Threshold : 0 TCA(enable) : NO
FRM-ERR[16] : 0 Threshold : 0 TCA(enable) : NO
FRM-ERR[17] : 0 Threshold : 0 TCA(enable) : NO
FRM-ERR[18] : 0 Threshold : 0 TCA(enable) : NO
FRM-ERR[19] : 0 Threshold : 0 TCA(enable) : NO
BAD-SH[00] : 0 Threshold : 0 TCA(enable) : NO
BAD-SH[01] : 0 Threshold : 0 TCA(enable) : NO
BAD-SH[02] : 0 Threshold : 0 TCA(enable) : NO
BAD-SH[03] : 0 Threshold : 0 TCA(enable) : NO
BAD-SH[04] : 0 Threshold : 0 TCA(enable) : NO
BAD-SH[05] : 0 Threshold : 0 TCA(enable) : NO
BAD-SH[06] : 0 Threshold : 0 TCA(enable) : NO
BAD-SH[07] : 0 Threshold : 0 TCA(enable) : NO
BAD-SH[08] : 0 Threshold : 0 TCA(enable) : NO
BAD-SH[09] : 0 Threshold : 0 TCA(enable) : NO
BAD-SH[10] : 0 Threshold : 0 TCA(enable) : NO
```

```

BAD-SH[11] : 0 Threshold : 0 TCA(enable) : NO
BAD-SH[12] : 0 Threshold : 0 TCA(enable) : NO
BAD-SH[13] : 0 Threshold : 0 TCA(enable) : NO
BAD-SH[14] : 0 Threshold : 0 TCA(enable) : NO
BAD-SH[15] : 0 Threshold : 0 TCA(enable) : NO
BAD-SH[16] : 0 Threshold : 0 TCA(enable) : NO
BAD-SH[17] : 0 Threshold : 0 TCA(enable) : NO
BAD-SH[18] : 0 Threshold : 0 TCA(enable) : NO
BAD-SH[19] : 0 Threshold : 0 TCA(enable) : NO
ES : 0 Threshold : 0 TCA(enable) : NO
SES : 0 Threshold : 0 TCA(enable) : NO
UAS : 0 Threshold : 0 TCA(enable) : NO
ES-FE : 0 Threshold : 0 TCA(enable) : NO
SES-FE : 0 Threshold : 0 TCA(enable) : NO
UAS-FE : 0 Threshold : 0 TCA(enable) : NO

```

```

Last clearing of "show controllers ETHERNET " counters never
RP/0/RP0/CPU0:BH1_P2A4#

```

**Example 7:** Displays the history *PCS* performance monitoring parameters of the 100GE controller at 30-second intervals.

```

RP/0/RP0/CPU0:ios#show controllers hundredGigEctrlr 0/0/0/2 pm history 30-sec pcs 1
Tue Nov 19 09:27:49.169 UTC

```

```

Ethernet PCS in the current interval [09:27:00 - 09:27:30 Tue Nov 19 2019]

```

```

Ethernet PCS current bucket type : Valid

```

```

BIP[00] : 0
BIP[01] : 0
BIP[02] : 0
BIP[03] : 0
BIP[04] : 0
BIP[05] : 0
BIP[06] : 0
BIP[07] : 0
BIP[08] : 0
BIP[09] : 0
BIP[10] : 0
BIP[11] : 0
BIP[12] : 0
BIP[13] : 0
BIP[14] : 0
BIP[15] : 0
BIP[16] : 0
BIP[17] : 0
BIP[18] : 0
BIP[19] : 0
FRM-ERR[00] : 0
FRM-ERR[01] : 0
FRM-ERR[02] : 0
FRM-ERR[03] : 0
FRM-ERR[04] : 0
FRM-ERR[05] : 0
FRM-ERR[06] : 0
FRM-ERR[07] : 0
FRM-ERR[08] : 0
FRM-ERR[09] : 0
FRM-ERR[10] : 0
FRM-ERR[11] : 0
FRM-ERR[12] : 0
FRM-ERR[13] : 0
FRM-ERR[14] : 0
FRM-ERR[15] : 0

```

```

FRM-ERR[16] : 0
FRM-ERR[17] : 0
FRM-ERR[18] : 0
FRM-ERR[19] : 0
BAD-SH[00] : 0
BAD-SH[01] : 0
BAD-SH[02] : 0
BAD-SH[03] : 0
BAD-SH[04] : 0
BAD-SH[05] : 0
BAD-SH[06] : 0
BAD-SH[07] : 0
BAD-SH[08] : 0
BAD-SH[09] : 0
BAD-SH[10] : 0
BAD-SH[11] : 0
BAD-SH[12] : 0
BAD-SH[13] : 0
BAD-SH[14] : 0
BAD-SH[15] : 0
BAD-SH[16] : 0
BAD-SH[17] : 0
BAD-SH[18] : 0
BAD-SH[19] : 0
ES : 0
SES : 0
UAS : 0
ES-FE : 0
SES-FE : 0
UAS-FE : 0

```

Last clearing of "show controllers ETHERNET " counters never  
RP/0/RP0/CPU0:BH1\_P2A4#

**Example 8:** Displays the current performance monitoring parameters of the optics controller at 10-second intervals as flexi-bin.

```

RP/0/RP0/CPU0:ios#show controllers optics 0/0/0/0 pm current flex-bin optics 1
Thu May 21 07:43:38.964 UTC

```

Optics in the current interval [07:43:30 - 07:43:38 Thu May 21 2020]

Flexible bin interval size: 10 seconds

Optics current bucket type : Valid

	Configured	MIN	AVG	MAX	Operational	Configured	TCA	Operational
					Threshold(min)	Threshold(min)	(min)	Threshold(max)
	Threshold(max)	(max)						
LBC[% ]	: 0.0	0.0	0.0	0.0	0.0	NA	NO	0.0
	NA	NO						
OPT[dBm]	: -0.13	-0.10	-0.06	0.00	0.00	NA	NO	0.00
	NA	NO						
OPR[dBm]	: -3.01	-2.96	-2.92	0.00	0.00	NA	NO	0.00
	NA	NO						
CD[ps/nm]	: -3	-2	-1	0	0	NA	NO	0
	NA	NO						
DGD[ps ]	: 1.00	1.67	2.00	0.00	0.00	NA	NO	0.00
	NA	NO						
SOPMD[ps^2]	: 17.00	37.00	81.00	0.00	0.00	NA	NO	0.00
	NA	NO						
OSNR[dB]	: 37.60	37.60	37.60	0.00	0.00	NA	NO	0.00
	NA	NO						

```

PDL[dB]      : 0.60      0.66      0.70      0.00      NA      NO      0.00
  NA          :          NO
PCR[rad/s]   : 0.00      29.11     80.00     0.00      NA      NO      0.00
  NA          :          NO
RX_SIG[dBm]  : -3.49     -3.41     -3.36     0.00      NA      NO      0.00
  NA          :          NO
FREQ_OFF[Mhz]: 191      241      301      0          NA      NO      0
  NA          :          NO
SNR[dB]      : 14.50     14.62     14.70     0.00      NA      NO      0.00
  NA          :          NO
SNR-AX[dB]   : 17.10     17.19     17.30     0.00      NA      NO      0.00
  NA          :          NO
SNR-AY[dB]   : 11.90     12.06     12.10     0.00      NA      NO      0.00
  NA          :          NO
SNR-BX[dB]   : 0.00      0.00      0.00      0.00      NA      NO      0.00
  NA          :          NO
SNR-BY[dB]   : 0.00      0.00      0.00      0.00      NA      NO      0.00
  NA          :          NO
SOP-S1       : 0.50      0.55      0.59      0.00      NA      NO      0.00
  NA          :          NO
SOP-S2       : -0.59     -0.52     -0.48     0.00      NA      NO      0.00
  NA          :          NO
SOP-S3       : -0.67     -0.64     -0.60     0.00      NA      NO      0.00
  NA          :          NO

```

Last clearing of "show controllers OPTICS" counters never

**Example 9:** Displays the history performance monitoring parameters of the optics controller at 10-second intervals as flexi-bin.

```
RP/0/RP0/CPU0:ios#show controllers optics 0/0/0/0 pm history flex-bin optics 1 bucket 1
Thu May 21 07:45:44.358 UTC
```

```
Optics in interval 1 [07:45:30 - 07:45:40 Thu May 21 2020]
```

```
Flexible bin interval size: 10 seconds
```

```
Optics history bucket type : Valid
```

```

          MIN      AVG      MAX
LBC[% ]   : 0.0      0.0      0.0
OPT[dBm]  : -0.12    -0.10    -0.04
OPR[dBm]  : -3.01    -2.97    -2.91
CD[ps/nm] : -5        -4        -3
DGD[ps ]  : 1.00     1.50     2.00
SOPMD[ps^2]: 28.00    43.10    66.00
OSNR[dB]  : 37.60    37.60    37.60
PDL[dB]   : 0.60     0.65     0.70
PCR[rad/s] : 0.00     25.70    75.00
RX_SIG[dBm] : -3.49    -3.44    -3.37
FREQ_OFF[Mhz]: 235     272     330
SNR[dB]   : 14.60    14.64    14.80
SNR-AX[dB]: 17.20    17.25    17.30
SNR-AY[dB]: 11.90    12.02    12.20
SNR-BX[dB]: 0.00     0.00     0.00
SNR-BY[dB]: 0.00     0.00     0.00
SOP-S1    : 0.50     0.53     0.57
SOP-S2    : -0.58    -0.53    -0.49
SOP-S3    : -0.69    -0.65    -0.61

```

**Example 10:** Displays the current FEC performance monitoring parameters of the coherentDSP controller as flexi-bin.

```
RP/0/0/CPU0:ios#show controllers coherentDSP 0/2/0/0 pm current flex-bin fec
```



Thu Apr 9 11:46:55.659 IST

g709 FEC in the current interval [11:46:50 - 11:46:55 Thu Apr 9 2020]

Flexible bin interval size: 10 seconds

FEC current bucket type : Valid

```

EC-BITS : 327          Threshold : 0          TCA(enable) :
NO
UC-WORDS : 327        Threshold : 0          TCA(enable) :
NO

```

TCA	MIN	AVG	MAX	Threshold	TCA	Threshold
(enable)				(min)	(enable)	(max)
PreFEC BER	5.20E-14	5.40E-14	5.70E-14	0E-15	NO	NO
0E-15 NO						
PostFEC BER	5.20E-14	5.40E-14	5.70E-14	0E-15	NO	NO
0E-15 NO						
Q[dB]	0.52	0.54	0.57	0.00	NO	0.00
NO						
Q_Margin[dB]	2.52	1.54	4.57	0.00	NO	0.00
NO						
<b>Q_Margin Instantaneous [dB]</b>	<b>2.52</b>	<b>1.54</b>	<b>4.57</b>	<b>0.00</b>	<b>NO</b>	<b>0.00</b>
NO						

Last clearing of "show controllers OTU" counters never

**Example 11:** Displays the current OTN path monitor performance monitoring parameters of the ODU4 controller 1-second intervals.

P/0/RP0/CPU0:ios#**show controllers odu4 0/2/0/13/8 pm current flex-bin otn pathmonitor**  
Wed Sep 22 12:47:09.497 UTC

g709 OTN in the current interval [12:47:08 - 12:47:08 Wed Sep 22 2021]

Flexible bin interval size: 1 seconds

OTN current bucket type : Valid

```

ES-NE : 0          Threshold : 0          TCA(enable) : NO
ESR-NE : 0.00000  Threshold : 0.00000 TCA(enable) : NO
SES-NE : 0          Threshold : 0          TCA(enable) : NO
SESR-NE : 0.00000 Threshold : 0.00000 TCA(enable) : NO
UAS-NE : 0          Threshold : 0          TCA(enable) : NO
BBE-NE : 0          Threshold : 0          TCA(enable) : NO
BBER-NE : 0.00000 Threshold : 0.00000 TCA(enable) : NO
FC-NE : 0          Threshold : 0          TCA(enable) : NO

ES-FE : 0          Threshold : 0          TCA(enable) : NO
ESR-FE : 0.00000  Threshold : 0.00000 TCA(enable) : NO
SES-FE : 0          Threshold : 0          TCA(enable) : NO
SESR-FE : 0.00000 Threshold : 0.00000 TCA(enable) : NO
UAS-FE : 0          Threshold : 0          TCA(enable) : NO
BBE-FE : 0          Threshold : 0          TCA(enable) : NO
BBER-FE : 0.00000 Threshold : 0.00000 TCA(enable) : NO
FC-FE : 0          Threshold : 0          TCA(enable) : NO

```

Last clearing of "show controllers ODU" counters never  
RP/0/RP0/CPU0:ios#

### Instantaneous Q-Margin

From Release 7.3.1 onwards, instantaneous Q-margin is supported for PM parameters on coherentDSP controller for 1.2T and 1.2TL cards. For more information, see [Q-Margin Support, on page 76](#).

### Scenarios on Instantaneous Q-margin

In the following scenarios, the initial few PM buckets are displayed as valid although the instantaneous Q-margin values are displayed as invalid in those buckets. The PM is performed for 30 sec, 15 mins, and 24 hours, respectively.

- Shutdown or no shutdown on optics
- BPS change on optics
- Trunk rate change
- Fiber cut

To overcome such situations, avoid the initial PM bucket readings while monitoring the instantaneous Q-margin values for these scenarios.

The following sample illustrates that the initial PM bucket readings for specified scenarios are invalid and at a later point the PM buckets readings are valid although the instantaneous Q-margin value is invalid.

```
RP/0/RP0/CPU0:ios#show controllers coherentDSP 0/2/0/0 pm history flex-bin fec 1
Mon Sep 14 06:16:03.249 UTC
```

```
g709 FEC in interval 1 [06:15:50 - 06:16:00 Mon Sep 14 2020]
```

```
Flexible bin interval size: 10 seconds
```

```
FEC history bucket type : Invalid. ----- > Instantaneous Q_margin is invalid in this bucket
```

```
EC-BITS : 38054
```

```
UC-WORDS : 0
```

	MIN	AVG	MAX
PreFEC BER	: 0E-15	3.26E-08	1.43E-07
PostFEC BER	: 0E-15	0E-15	0E-15
Q	: 0.00	5.73	14.40
Q_margin	: -5.00	-0.69	9.40
Instantaneous Q_margin	: -21474836.48	-8589934.59	0.00

Now, the PM buckets are valid although the instantaneous Q-margin value is invalid.

```
RP/0/RP0/CPU0:ios#show controllers coherentDSP 0/2/0/0 pm history 30-sec fec 1
Mon Sep 14 06:16:53.490 UTC
```

```
g709 FEC in interval 1 [06:16:00 - 06:16:30 Mon Sep 14 2020]
```

```
FEC history bucket type : Valid ----- > (Instantaneous Q_margin is invalid but the PM bucket is valid. So these initial bins can be ignored)
```

```
EC-BITS : 431887
```

```
UC-WORDS : 0
```

	MIN	AVG	MAX
PreFEC BER	: 3.97E-09	4.83E-08	1.51E-07
PostFEC BER	: 0E-15	0E-15	0E-15
Q	: 14.40	14.48	14.60
Q_margin	: 9.30	9.46	9.60
Instantaneous Q_margin	: -21474836.48	-5010784.19	14.42

## Clearing PM Parameters

To clear the performance monitoring parameters for Ethernet and Coherent DSP controllers, use this command:

**clear controller** *controllertype R/S/I/P* **pm**

**Example 1:** Clears the PM parameters on the Coherent DSP controller.

```
RP/0/RP0/CPU0:ios#show controller CD 0/0/0/0 pm current 15-min fec
Mon Jun 10 11:43:39.981 UTC

g709 FEC in the current interval [11:30:00 - 11:43:40 Mon Jun 10 2019]

FEC current bucket type : Invalid
  EC-BITS   : 308360273          Threshold : 903330          TCA(enable) :
YES
  UC-WORDS  : 131108352          Threshold : 5                TCA(enable)  :
YES

          MIN      AVG      MAX      Threshold  TCA      Threshold  TCA
          (min)    (enable) (max)    (min)      (enable) (max)      (enable)
PreFEC BER : 3.44E-02  3.45E-02  3.45E-02  0E-15      NO       0E-15      NO
PostFEC BER : 0E-15     0E-15     0E-15     0E-15      NO       0E-15      NO
Q           : 0.51     0.51     0.51     0.00       NO       0.00       NO
Q_Margin    : 0.00     0.00     0.00     0.00       NO       0.00       NO

Last clearing of "show controllers OTU" counters never
RP/0/RP0/CPU0:ios#clear controller coherentDSP 0/0/0/0 pm
Mon Jun 10 11:44:31.650 UTC
RP/0/RP0/CPU0:ios#show controller CD 0/0/0/0 pm current 15-min fec
Mon Jun 10 11:44:38.804 UTC

g709 FEC in the current interval [11:30:00 - 11:44:38 Mon Jun 10 2019]

FEC current bucket type : Invalid
  EC-BITS   : 0                  Threshold : 903330          TCA(enable) :
YES
  UC-WORDS  : 0                  Threshold : 5                TCA(enable)  :
YES

          MIN      AVG      MAX      Threshold  TCA      Threshold  TCA
          (min)    (enable) (max)    (min)      (enable) (max)      (enable)
PreFEC BER : 3.44E-02  3.44E-02  3.45E-02  0E-15      NO       0E-15      NO
PostFEC BER : 0E-15     0E-15     0E-15     0E-15      NO       0E-15      NO
Q           : 0.51     0.51     0.51     0.00       NO       0.00       NO
Q_Margin    : 0.00     0.00     0.00     0.00       NO       0.00       NO

Last clearing of "show controllers OTU" counters 00:00:07
```

**Example 2:** Clears the PM parameters on the Ethernet controller.

```
RP/0/RP0/CPU0:ios#clear controller HundredGigECtrlr 0/0/0/2 pm
```

## Viewing PM Statistics

To view PM statistics for the Ethernet controllers, use this command:

```
RP/0/RP0/CPU0:ios#show controllers HundredGigECtrlr 0/0/0/2 stats
Fri Aug 30 13:10:33.123 IST
Statistics for interface HundredGigECtrlr0/0/0/2 (cached values):

Ingress:
  Input total bytes          = 1702197139760640
```

```

Input good bytes          = 1702197139760640

Input total packets      = 13298415154380
Input 802.1Q frames      = 0
Input pause frames       = 0
Input pkts 64 bytes      = 0
Input pkts 65-127 bytes  = 0
Input pkts 128-255 bytes = 13298415154380
Input pkts 256-511 bytes = 0
Input pkts 512-1023 bytes = 0
Input pkts 1024-1518 bytes = 0
Input pkts 1519-Max bytes = 0

Input good pkts          = 13298415154380
Input unicast pkts      = 0
Input multicast pkts     = 0
Input broadcast pkts     = 0

Input drop overrun       = 0
Input drop abort         = 0
Input drop invalid VLAN  = 0
Input drop invalid DMAC  = 0
Input drop invalid encap = 0
Input drop other         = 0

Input error giant        = 0
Input error runt         = 0
Input error jabbers      = 0
Input error fragments  = 0
Input error CRC          = 0
Input error collisions   = 0
Input error symbol       = 0
Input error other        = 0

Input MIB giant          = 0
Input MIB jabber         = 0
Input MIB CRC            = 0

Egress:
Output total bytes       = 1702197139760640
Output good bytes        = 1702197139760640

Output total packets     = 13298415154380
Output 802.1Q frames     = 0
Output pause frames      = 0
Output pkts 64 bytes     = 0
Output pkts 65-127 bytes = 0
Output pkts 128-255 bytes = 13298415154380
Output pkts 256-511 bytes = 0
Output pkts 512-1023 bytes = 0
Output pkts 1024-1518 bytes = 0
Output pkts 1519-Max bytes = 0

Output good pkts        = 13298415154380
Output unicast pkts    = 0
Output multicast pkts   = 0
Output broadcast pkts   = 0

Output drop underrun    = 0
Output drop abort       = 0
Output drop other       = 0

Output error other      = 0

```

```
RP/0/RP0/CPU0:ios#
```



**Note** Performance monitoring statistics are not supported for the input unicast packets, output unicast packets, and input error fragments counters for Ethernet clients.

### Configuring PM with Flexible Bin Interval as 1 Second

To configure PM with flexible bin interval as 1 second, use the following commands:

```
RP/0/RP0/CPU0:ios#configure terminal
Thu Sep 30 10:38:39.729 UTC
RP/0/RP0/CPU0:ios(config)#performance-monitor-engine flex-bin interval 1
RP/0/RP0/CPU0:ios(config)#commit
Thu Sep 30 10:38:57.987 UTC
RP/0/RP0/CPU0:ios(config)#
```

To view PM statistics for *OTN path monitor* with flexible bin interval as 1 second, use this command:

```
P/0/RP0/CPU0:ios#show controllers odu4 0/2/0/13/8 pm current flex-bin otn pathmonitor
Wed Sep 22 12:47:09.497 UTC
```

```
g709 OTN in the current interval [12:47:08 - 12:47:08 Wed Sep 22 2021]
```

#### Flexible bin interval size: 1 seconds

```
OTN current bucket type : Valid
ES-NE : 0 Threshold : 0 TCA(enable) : NO
ESR-NE : 0.00000 Threshold : 0.00000 TCA(enable) : NO
SES-NE : 0 Threshold : 0 TCA(enable) : NO
SESR-NE : 0.00000 Threshold : 0.00000 TCA(enable) : NO
UAS-NE : 0 Threshold : 0 TCA(enable) : NO
BBE-NE : 0 Threshold : 0 TCA(enable) : NO
BBER-NE : 0.00000 Threshold : 0.00000 TCA(enable) : NO
FC-NE : 0 Threshold : 0 TCA(enable) : NO

ES-FE : 0 Threshold : 0 TCA(enable) : NO
ESR-FE : 0.00000 Threshold : 0.00000 TCA(enable) : NO
SES-FE : 0 Threshold : 0 TCA(enable) : NO
SESR-FE : 0.00000 Threshold : 0.00000 TCA(enable) : NO
UAS-FE : 0 Threshold : 0 TCA(enable) : NO
BBE-FE : 0 Threshold : 0 TCA(enable) : NO
BBER-FE : 0.00000 Threshold : 0.00000 TCA(enable) : NO
FC-FE : 0 Threshold : 0 TCA(enable) : NO
```

Last clearing of "show controllers ODU" counters never





## CHAPTER 5

# IP Access Lists

---

This chapter describes how to configure IPv4 and IPv6 Access Control Lists (ACL).

- [IP Access List, on page 165](#)

## IP Access List

### How an IP Access List Works

An access list is a sequential list consisting of permit and deny statements that apply to IP addresses and possibly the upper-layer IP protocols. ACLs are used to permit or deny the flow of packets based on matching criteria of access list parameters and information contained in packets. For it to be in effect, an access list must be created and applied to an interface.

An access list can control traffic arriving or leaving the system, but not traffic originating at the system.

### IP Access List Process and Rules

There are two paths for interface packet filtering for ACL configuration:

- **Hardware programming path:** Hardware programming path is the fast path ACL configuration. The fast path ACL configuration requires Ternary Content Addressable Memory (TCAM) through packet filter Execution Agent.
- **Software programming path:** Software programming path is the slow path ACL configuration. The slow path ACL configuration requires adding caps to Interface Manager and NetIO.

Use the following process and rules when configuring an IP access list:

- The software tests the source or destination address or the protocol of each packet being filtered against the conditions in the access list, one condition (permit or deny statement) at a time.
- If a packet does not match a statement in the access list, it is tested against the next statement in the list.
- If a packet matches an access list statement, the remaining statements in the list are skipped, and the packet is permitted or denied as specified in the matched statement.
- If the access list denies the address or the protocol, the software discards the packet and returns an Internet Control Message Protocol (ICMP) Host Unreachable message. ICMP is configurable in the Cisco IOS XR software.
- If no conditions match, the software drops the packet because each access list ends with an unwritten or implicit deny statement.

- The access list should contain at least one permit statement; otherwise, all packets are denied.
- The software stops testing the conditions after the first match; so, the order of the conditions is critical. The same permit or deny statements specified in a different order could result in a packet being passed under one circumstance and denied in another circumstance.
- Only one access list per interface, per protocol, per direction is allowed.
- Inbound access lists process packets arriving at the system. Incoming packets are processed before being routed to an outbound interface. An inbound access list is efficient as it saves the overhead of routing lookups if the packet is to be discarded because it is denied by the filtering tests. If the packet is permitted by the tests, it is then processed for routing. For inbound lists, "permit" means continue to process the packet after receiving it on an inbound interface; "deny" means discard the packet.
- Outbound access lists process packets before they leave the system. Incoming packets are routed to the outbound interface and then processed through the outbound access list. For outbound lists, "permit" means send it to the output buffer; "deny" means discard the packet.
- An access list cannot be removed if that access list is being applied by an access group in use. To remove an access list, remove the access group that is referencing the access list and then remove the access list.
- An access-list must be created first before it can actually be applied on the management interface using access-group command.
- ACLs apply only on management interfaces and not on any other type of interfaces or controllers.

Statistics collections are also divided into fast path packets and slow path packets. ACLs information is stored as a global data on the route processor.

#### Support of IP Access list in NCS 1004:

NCS 1004 supports the following:

- Ingress ACL for both IPv4 and IPv6.
- Slow packet path for Management Interface.
- Egress ACL: Self-Originated Packet is not supported by ACL, because this is already controlled by the user. Only forwarded packets or traffic classify under ACL. This rule is applicable for both IPv4 and IPv6 ACL.

## Configuring an IP Access List

To configure the ACL, use the following commands at the IPv4 or IPv6 interface:

**configure**

**interface** *interface-type Rack/Slot/Instance/Port*

**ipv4 | ipv6 access-group** *access-list-name* {**ingress** | **egress**}

**commit**

#### Example

```
interface MgmtEth0/RP0/CPU0/0
ipv4 address 10.1.1.1 255.255.255.0
ipv6 address 1000::1/64
ipv4 access-group IPV4_ICMP_DENY ingress
```



```

ipv4 access-group IPV4_ROUTER_FWD_TELNET_TRAFFIC_DENY egress
ipv6 access-group IPV6_SSH_DENY ingress
ipv6 access-group IPV6_ROUTER_FWD_TELNET_TRAFFIC_DENY egress

```

### Sample Configuration for IPv4 Access Lists

```

ipv4 access-list IPV4_ICMP_DENY
10 deny icmp any any
20 permit ipv4 any any
!
ipv4 access-list IPV4_ROUTER_FWD_TELNET_TRAFFIC_DENY
10 deny tcp any any eq telnet
20 permit ipv4 any any
!

```

### Sample Configuration for IPv6 Access Lists

```

ipv6 access-list IPV6_SSH_DENY
10 deny tcp any any eq ssh
20 permit ipv6 any any
!
ipv6 access-list IPV6_ROUTER_FWD_TELNET_TRAFFIC_DENY
10 deny tcp any any eq telnet
20 permit ipv6 any any
!

```

## Verifying ACLs

The following examples verify the number of packets filtered by the respective ACLs:

### IPv4:

```

RP/0/RP0/CPU0:ios#show access-lists ipv4
Wed Jan 17 09:52:12.448 IST
ipv4 access-list IPV4_ICMP_DENY
10 deny icmp any any (8 matches)
20 permit ipv4 any any (106 matches)
ipv4 access-list IPV4_ROUTER_FWD_TELNET_TRAFFIC_DENY
10 deny tcp any any eq telnet (3 matches)
20 permit ipv4 any any (6 matches)

```

### IPv6:

```

RP/0/RP0/CPU0:ios#show access-lists ipv6
Wed Jan 17 09:52:14.591 IST
ipv6 access-list IPV6_ROUTER_FWD_TELNET_TRAFFIC_DENY
10 deny tcp any any eq telnet (3 matches)
20 permit ipv6 any any (5 matches)
ipv6 access-list IPV6_SSH_DENY
10 deny tcp any any eq ssh (9 matches)
20 permit ipv6 any any (100 matches)

```





# CHAPTER 6

## Layer 1 Encryption

This chapter describes how to configure the IKEv2 protocol and layer 1 encryption for NCS 1004.



**Note** In this chapter, "layer 1 encryption" is referred to as "OTNSec".

**Table 23: Feature History**

Feature Name	Release Information	Feature Description
Encryption Support on 1.2TL Card	Cisco IOS XR Release 7.3.1	AES 256 GCM authenticated OTNSec encryption on 1.2TL line cards is supported. It uses only pre-shared keys for authentication. Optical encryption secures the communications link in and out of a facility, rendering all data undecipherable to hackers who tap into networks.

### The Need for High Speed Encryption

Most of the emphasis on protecting networks today is focused on protecting data within data center. However, the infrastructure of networks that connect these data centers are as vulnerable to calculated attacks as the data centers themselves. As more sensitive information gets transmitted across fiber-optic networks, cyber criminals are increasingly turning their attention to intercepting the data when it travels across the network.

With the increase in network or fiber optic hacks, the need for data protection is paramount. Encryption of any data that leaves the data centers is becoming an important requirement for cloud operators. Optical encryption secures everything on the communications link in and out of a facility rendering all data undecipherable to any hacker that taps into the fiber strand. *Protecting data at high speeds or lines rates is a requirement for data centers today.*

The Cisco NCS 1004 brings to you AES256 based OTNSec encryption for 100GE and OTU4 clients. Encryption is supported on the 1.2T and 1.2TL cards.

OTNSec encryption uses the IKEv2 protocol to negotiate and establish the IKEv2 and OTNSec Security Associations (SA). IKEv2 is used for authentication of the devices in an encryption session, and the protocol

provides pre-shared keys (PSK) or RSA certificate-based authentication. The IKEv2 datagrams are carried as payloads using the point-to-point protocol (PPP) over the GCC channel.

To implement this, an IKE session is established between the two endpoints, Site A and Site B, for overhead control plane communication between the two data centers. Data is then encrypted at Site A using OTNSec encryption and decrypted at Site B.

**Figure 1: OTNSec Site-to-Site Example and Components**

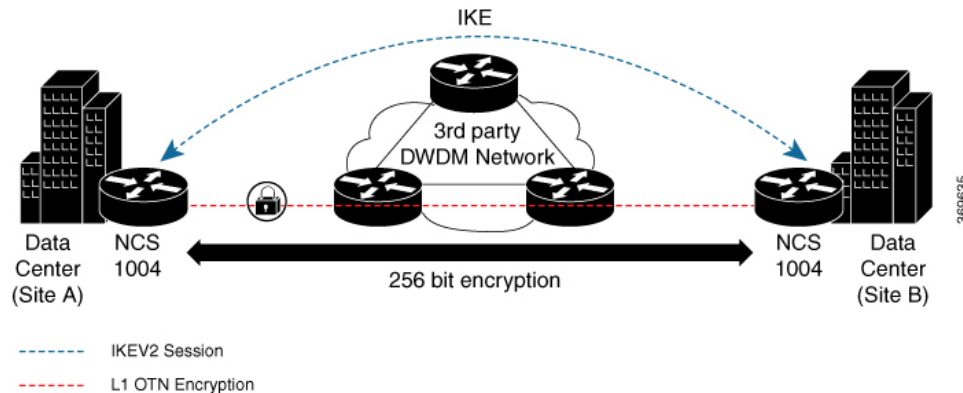

The recommended deployment is to have a single IKEv2 session running over a GCC2 channel per trunk port which creates the child SAs for each of the OTNSec controllers that are configured on the trunk port.

- [IKEv2 Overview, on page 170](#)
- [OTNSec Encryption Overview, on page 172](#)
- [Prerequisites, on page 173](#)
- [Limitations, on page 174](#)
- [Configuration Workflow, on page 174](#)
- [Configuration Example, on page 181](#)
- [Verification, on page 184](#)
- [Troubleshooting, on page 185](#)
- [IKEv2 Certificate-Based Authentication, on page 185](#)
- [You May Be Interested In, on page 189](#)

## IKEv2 Overview

Internet Key Exchange Version 2 (IKEv2) is a request and response encryption that establishes and handles security associations (SA) in an authentication suite, such as OTNSec, to ensure secure traffic. IKE performs mutual authentication between two endpoints and establishes an IKE Security Association (SA). All IKE communications consist of pairs of messages that include a request and a response. The pair is called an exchange or a request-response pair. The first two exchanges of messages establishing an IKE SA are called the IKE\_SA\_INIT exchange and the IKE\_AUTH exchange; subsequent IKE exchanges are called either CREATE\_CHILD\_SA exchanges or INFORMATIONAL exchanges. IKEv2 uses sequence numbers and acknowledgments to provide reliability, and mandates some error-processing logistics and shared state management (windowing). IKEv2 does not process a request until it determines the requester. This helps to mitigate DoS attacks. IKEv2 provides built-in support for Dead Peer Detection (DPD), which periodically confirms the availability of the peer node. When there is no response from the peer node, the system attempts to establish the session again.

Figure 2: IKEv2 Exchanges

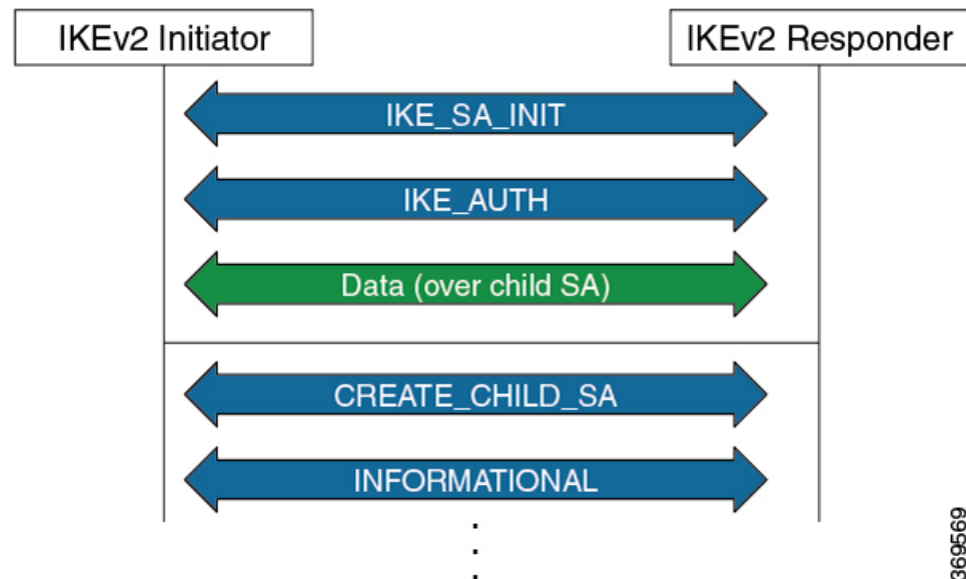

IKEv2 is defined in RFC 7296 and consists of the following constructs:

- **Keyring**

A keyring is a repository of symmetric and asymmetric pre-shared keys that is configured for a peer and identified using the IP address of the peer. The keyring is associated with an IKEv2 profile and therefore, caters to a set of peers that match the IKEv2 profile. This is a required configuration for the pre-shared keys authentication method that is used for NCS 1004.



**Note** The certificate-based authentication that uses RSA signatures can be used instead of the keyring. If both methods of authentication are configured, the certificate-based authentication takes precedence. See [IKEv2 Certificate-Based Authentication, on page 185](#).

- **IKEv2 Profile**

An IKEv2 profile is a repository of nonnegotiable parameters of the IKE SA, such as authentication method and services that are available to the authenticated peers that match the profile. The profile match lookup is done based on the IP address of the remote identity. For security purposes, the IKE SAs have a lifetime that is defined in the IKEv2 profile. The lifetime range, in seconds, is from 120 to 86400. The SAs are rekeyed proactively before the expiry of the lifetime. The default lifetime is 86400. An IKEv2 profile must be attached to an OTNSec configuration on the ODU4 controllers on both the IKEv2 initiator and responder. This is a required configuration.



---

**Note** Only one authentication method is supported for the local peer but multiple authentication methods can be configured for the remote peer.

If both methods of authentication are configured, keyring and certificate trustpoint (see, [IKEv2 Certificate-Based Authentication, on page 185](#)) in the profile, the remote peer can authenticate itself using either method. **authentication remote [pre-shared] rsa-signature** can be used to exclusively control the remote authentication method. Similarly, **authentication local [pre-shared] rsa-signature** can be used to exclusively configure local authentication method. If it is not configured, the certificate-based authentication takes precedence.

---

#### • IKEv2 Proposal

An IKEv2 proposal is a collection of transforms that are used in the negotiation of IKE SAs as part of the IKE\_SA\_INIT exchange. The IKE2 proposal must be attached to an IKEv2 policy. This is an optional configuration. The transform types used in the negotiation are as follows:

- Encryption algorithm
- Integrity algorithm
- Pseudo-Random Function (PRF) algorithm
- Diffie-Hellman (DH) group



---

**Note** The IKEv2 proposal must have at least one algorithm of each type. It is possible to specify multiple algorithms for each type; the order in which the algorithms are specified determines the precedence.

---

#### • IKEv2 Policy

IKEv2 employs policies that are configured on each peer to negotiate handshakes between the two peers. An IKEv2 policy contains proposals that are used to negotiate the encryption, integrity, PRF algorithms, and DH group in the SA\_INIT exchange. An IKEv2 policy is selected based on the local IP address. This is an optional configuration.



---

**Note** The default IKEv2 proposal is used with default IKEv2 policy in the absence of any user-defined policy.

---

## OTNSec Encryption Overview

OTNSec encryption in NCS 1004 has the following characteristics:

- The OTN layer 1 security is supported over the OPU client payload.

- The Galois-Counter-Mode (GCM) AES 256-bit security is the default cipher used for encryption and decryption of the OPU payloads.
- Each client offers an independent encrypted channel in each direction.
- There are two banks of 256-bit programmable key registers (current key and future key) that permit key updates through the software without interrupting traffic.  
Each key is associated with an Association Number [AN(1:0)] allowing up to four different numbers.
- Interhost key exchange is supported through communication over GCC.
- The encryption is supported in headless mode.

The OTNSec control plane generates two different keys, one for the transmit (Tx) side and the other for the receive (Rx) side. These keys are used by the line card to program the encryptor and decryptor blocks. These blocks encrypt and decrypt the data packets between the trunk ports of the two nodes. For security purposes, the keys have a lifetime. A key's lifetime specifies the time the key expires.

The key lifetime for the child SAs can be configured using the sak-rekey-interval which ranges from 30 seconds to 14 days. For example, if the sak-rekey-interval is configured for five minutes, a new key is generated by the OTNSec layer every five minutes. In the absence of a lifetime configuration, the default lifetime is 14.18 days. When the key reaches the maximum lifetime, it becomes invalid and the CRYPTO-KEY-EXPIRED alarm is raised. Volume-based rekeying is supported; it prevents the key from reaching the maximum lifetime. This allows the OTNSec layer to generate a new key when 70% of the lifetime (11 days) of the current key is over.

When the lifetime of the first key expires, it automatically rolls over to the next key. To achieve a hitless rollover, the lifetimes of the keys need to be overlapped so that for a certain period of time both keys are active. To maintain this seamless switchover, a key index table is maintained. Each key pair (Tx and Rx) is associated with an Association Number (AN). The index table allows up to four numbers (0,1, 2, and 3). When the keys are installed, the Rx AN number of node A must match the Tx AN number of node B. Also, the Tx AN number of node A must match the Rx AN number of node B. If there is a mismatch of the AN numbers between the peer nodes, the CRYPTO-INDEX-MISMATCH alarm is raised.

## Prerequisites

- Ensure that the required k9sec.rpm package is installed.
- Configure the line card in the muxponder or muxponder slice mode using the following commands:

- **1.2T Card:**

- muxponder mode:

**hw-module location *location* mxponder client-rate 100GE | OTU4**

**hw-module location *location* mxponder trunk-rate {100G | 200G | 300G | 400G | 500G | 600G}**

- muxponder slice mode:

**hw-module location *location* mxponder-slice *mxponder-slice-number* client-rate 100GE | OTU4**

**hw-module location *location* mxponder-slice trunk-rate { 100G | 200G | 300G | 400G | 500G | 600G }**

• **1.2TL Card:**

- muxponder mode:

**hw-module location** *location* **mxponder client-rate 100GE | OTU4**

**hw-module location** *location* **mxponder trunk-rate {200G | 300G | 400G }**

- muxponder slice mode:

**hw-module location** *location* **mxponder-slice *mxponder-slice-number* client-rate 100GE | OTU4**

**hw-module location** *location* **mxponder-slice trunk-rate { 200G | 300G | 400G }**

# Limitations

- Traffic is impacted for a few seconds if the RP fails or GCC2 control plane goes down, during a key rollover.
- The sak-rekey-interval must be configured on the initiator and responder node.

# Configuration Workflow

This section describes the workflow to configure IKEv2 and OTNSec encryption on NCS 1004. The authentication method used is pre-shared keys (PSKs).

**Figure 3: L1 Encryption Workflow**

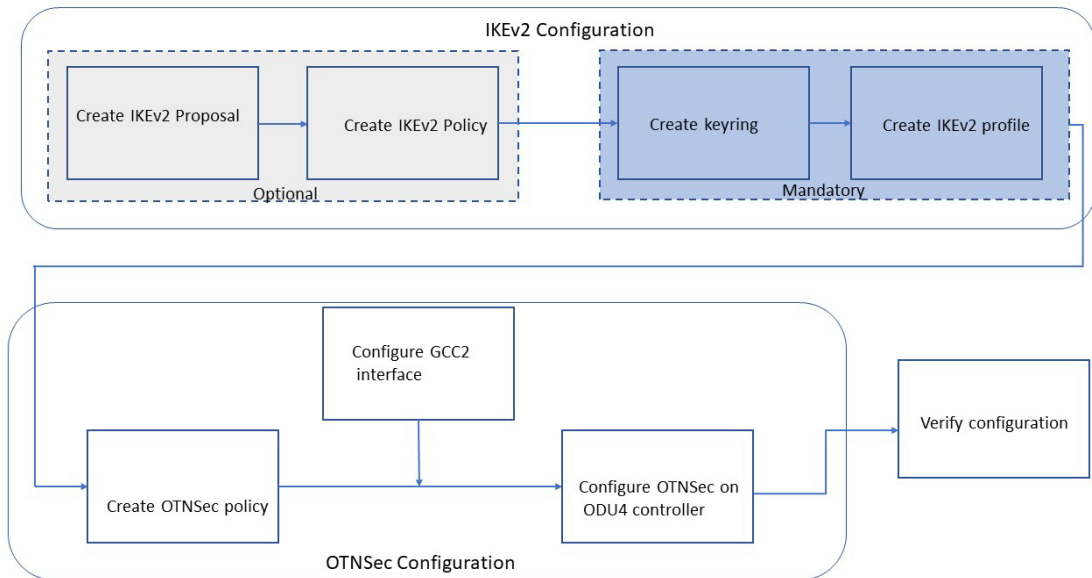

369571



Table 24: Workflow for Configuring IKEv2 and OTNSec Encryption on NCS 1004

Workflow Sequence	Details
<b>IKE Configuration</b>	
<a href="#">Configuring an IKEv2 Proposal, on page 176</a>	<p>(Optional) Configure an IKEv2 proposal manually; otherwise, the default IKEv2 proposal is used in the default IKEv2 policy.</p> <p>The default IKEv2 proposal requires no configuration and is a collection of commonly used transforms types, which are as follows:</p> <pre> encryption cbc-aes-256 integrity sha512, sha384 prf sha512, sha384 dh 19, 20, 21 </pre>
<a href="#">Configuring an IKEv2 Policy, on page 177</a>	<p>(Optional) Configure an IKEv2 policy manually; otherwise, the default proposal associated with the default policy is used for negotiation.</p> <p><b>Note</b> An IKEv2 policy with no proposal is considered incomplete.</p>
<a href="#">Configuring a Keyring, on page 177</a>	Configure a keyring as the local or remote authentication method is a preshared key.
<a href="#">Configuring a IKEv2 Profile, on page 178</a>	<p>Configure an IKEv2 profile.</p> <p><b>Note</b></p> <ul style="list-style-type: none"> <li>• The IKEv2 profile must be attached to the OTNSec profile on both the IKEv2 initiator and the responder.</li> <li>• The DPD interval is 10 seconds. If there is no response from the peer node, it retries every two seconds with a maximum of five attempts. After five retries, the IKE session is brought down. NCS 1004 supports headless mode. Therefore, even though the control plane is down, traffic is not impacted because the encryption and decryption keys are still active on the line cards. The data path functions in a locally secure mode and the OTNSEC-LOCALLY-SECURED alarm is raised.</li> </ul>
<b>OTNSec Configuration</b>	
<a href="#">Configuring an OTNSec Policy, on page 179</a>	(Optional) Configure the OTNSec policy.
<a href="#">Configuring the GCC Interface, on page 180</a>	Configure the GCC2 interface.

Workflow Sequence	Details
<a href="#">Configuring OTNSec on ODU4 Controllers, on page 180</a>	Configure the ODU4 controller that is mapped to the HundredGigE controller .
<b>Verification</b>	
<a href="#">Verification, on page 184</a>	Verify the IKEv2 and OTNSec configuration.

## Configuring an IKEv2 Proposal

To configure an IKEv2 proposal, use the following commands:

```

config
ikev2 proposal proposal-name
encryption {aes-gcm-256} {aes-gcm-128} {aes-cbc-256} {aes-cbc-192} {aes-cbc-128}
integrity {sha-1} {sha-256} {sha-384} {sha-512}
prf {sha-1} {sha-256} {sha-384} {sha-512}
dh {19} {20} {21}
    
```



**Note** Configuring an AES-GCM encryption algorithm does not require configuring an integrity algorithm. AES-GCM and non-GCM algorithms cannot be configured in the same proposal. However, you can configure the AES-GCM and non-GCM algorithms under two different proposals and attach both the proposals to the same IKEv2 policy.

The following sample displays how to configure an IKEv2 proposal.

```

RP/0/RP0/CPU0:ios#configure
Thu Mar  7 19:19:30.259 UTC
RP/0/RP0/CPU0:ios(config)#ikev2 proposal proposall
RP/0/RP0/CPU0:ios(config-ikev2-proposal-proposall)#encryption aes-cbc-256
RP/0/RP0/CPU0:ios(config-ikev2-proposal-proposall)#integrity sha-1
RP/0/RP0/CPU0:ios(config-ikev2-proposal-proposall)#prf sha-256
RP/0/RP0/CPU0:ios(config-ikev2-proposal-proposall)#dh 20
RP/0/RP0/CPU0:ios(config-ikev2-proposal-proposall)#commit
Thu Mar  7 19:20:30.916 UTC
RP/0/RP0/CPU0:ios(config-ikev2-proposal-proposall)#exit
RP/0/RP0/CPU0:ios(config)#exit
RP/0/RP0/CPU0:ios#show ikev2 proposal proposall
Thu Mar  7 19:20:48.929 UTC

Proposal Name           : proposall
=====
Status                  : Complete
=====
Total Number of Enc. Alg. : 1
  Encr. Alg.             : CBC-AES-256
-----
Total Number of Hash. Alg. : 1
  Hash. Alg.             : SHA 1
-----
Total Number of PRF. Alg. : 1
    
```

```

PRF. Alg.                : SHA 256
-----
Total Number of DH Group : 1
DH Group                 : Group 20

```

## Configuring an IKEv2 Policy

To configure an IKEv2 policy, use the following commands:

**config**

**ikev2 policy** *policy-name*

**proposal** *proposal-name1 proposal-name2 proposal-name3*

**match address local** { *ipv4-address* }

The following sample displays how to configure an IKEv2 policy.

```

RP/0/RP0/CPU0:ios#configure
Thu Mar  7 19:26:45.752 UTC
RP/0/RP0/CPU0:ios(config)#ikev2 policy mypolicy
RP/0/RP0/CPU0:ios(config-ikev2-policy-mypolicy)#proposal proposal1
RP/0/RP0/CPU0:ios(config-ikev2-policy-mypolicy)#match address local 10.1.1.1
RP/0/RP0/CPU0:ios(config-ikev2-policy-mypolicy)#commit
Thu Mar  7 19:29:25.043 UTC
RP/0/RP0/CPU0:ios(config-ikev2-policy-mypolicy)#exit
RP/0/RP0/CPU0:ios(config)#exit
RP/0/RP0/CPU0:ios#show ikev2 policy mypolicy
Thu Mar  7 19:30:30.343 UTC

```

```

Policy Name                : mypolicy
=====
Total number of match local addr : 1
  Match address local       : 10.1.1.1
-----
Total number of proposal attached : 1
  Proposal Name             : proposal1

```

## Configuring a Keyring

To configure a keyring, use the following commands:

**config**

**keyring** *keyring-name*

**peer** *peer-block name*

**address** { *ipv4-address [mask]* }



**Note** The IP address of the far-end node (remote node) must be used.

**pre-shared-key** {{*key*} {**clear** *clear-text key*} {**local** *local key*} {**password***encrypted key*}}



**Note** The key input can either be in clear text or in type 7 encrypted password format.

The following sample displays how to configure a keyring.

```
RP/0/RP0/CPU0:ios#configure
Thu Mar 7 19:33:14.594 UTC
RP/0/RP0/CPU0:ios(config)#keyring kyr1
RP/0/RP0/CPU0:ios(config-keyring-kyr1)#peer peer1
RP/0/RP0/CPU0:ios(config-keyring-kyr1-peer-peer1)#address 10.1.1.2 255.255.255.0
RP/0/RP0/CPU0:ios(config-keyring-kyr1-peer-peer1)#pre-shared-key password 106D000A064743595F
RP/0/RP0/CPU0:ios(config-keyring-kyr1-peer-peer1)#commit
Thu Mar 7 19:54:33.314 UTC
RP/0/RP0/CPU0:ios(config-keyring-kyr1-peer-peer1)#exit
RP/0/RP0/CPU0:ios(config-keyring-kyr1)#exit
RP/0/RP0/CPU0:ios(config)#exit
RP/0/RP0/CPU0:ios#show keyring kyr1
Thu Mar 7 19:58:07.135 UTC

Keyring Name                : kyr1
=====
Total Peers                  : 1
-----
Peer Name                    : peer1
IP Address                   : 10.1.1.2
Subnet Mask                  : 255.255.255.0
Local PSK                    : Configured
Remote PSK                   : Configured
```

## Configuring a IKEv2 Profile

To configure an IKEv2 profile, use the following commands:

```
config
ikev2 profile profile-name
match identity remote address {ipv4-address [mask]}
keyring keyring-name
lifetime seconds
```



**Note** The lifetime range, in seconds, is from 120 to 86400.

The following sample displays how to configure an IKEv2 profile.

```
RP/0/RP0/CPU0:ios#configure
Thu Mar 7 20:00:36.490 UTC
RP/0/RP0/CPU0:ios(config)#ikev2 profile profile1
RP/0/RP0/CPU0:ios(config-ikev2-profile-profile1)#match identity remote address 10.1.1.2
255.255.255.0
RP/0/RP0/CPU0:ios(config-ikev2-profile-profile1)#keyring kyr1
RP/0/RP0/CPU0:ios(config-ikev2-profile-profile1)#lifetime 120
RP/0/RP0/CPU0:ios(config-ikev2-profile-profile1)#commit
Thu Mar 7 20:15:03.401 UTC
RP/0/RP0/CPU0:ios(config-ikev2-profile-profile1)#exit
RP/0/RP0/CPU0:ios(config)#exit
RP/0/RP0/CPU0:ios#show ikev2 profile profile1
Thu Mar 7 20:15:25.776 UTC

Profile Name                : profile1
=====
```

```

Keyring                               : kyr1
Lifetime (Sec)                         : 120
DPD Interval (Sec)                     : 10
DPD Retry Interval (Sec)               : 2
Match ANY                              : NO
Total Match remote peers               : 1
Addr/Prefix                            : 10.1.1.2/255.255.255.0

```

## Configuring an OTNSec Policy

To configure an OTNSec policy, use the following commands:

**config**

**otnsec-policy** *policy-name*

**cipher-suite** **AES-GCM-256**

**security-policy** **must-secure**

**sak-rekey-interval** *seconds*



---

**Note** The interval range, in seconds, is from 30 to 1209600. SAK rekey timer does not start by default until it is configured.

---

The following sample displays how to configure an OTNSec policy.

```

RP/0/RP0/CPU0:ios#configure
Mon Mar 11 15:16:58.417 UTC
RP/0/RP0/CPU0:ios(config)#otnsec policy otnsec-policy1
RP/0/RP0/CPU0:ios(config-otnsec-policy)#cipher-suite AES-GCM-256
RP/0/RP0/CPU0:ios(config-otnsec-policy)#security-policy must-secure
RP/0/RP0/CPU0:ios(config-otnsec-policy)#sak-rekey-interval 120
RP/0/RP0/CPU0:ios(config-otnsec-policy)#commit

```

The following is a sample of an OTNSec policy.

```

RP/0/RP0/CPU0:ios#show run otnsec policy otnsec-policy1
Tue Mar 12 11:14:03.591 UTC
otnsec policy otnsec-policy1
 cipher-suite AES-GCM-256
 security-policy must-secure
 sak-rekey-interval 120
!

```



---

**Note** When a software upgrade is performed from R.7.0.1 to later releases, traffic is impacted. This happens if the sak-rekey-interval is configured. To prevent traffic loss, disable the sak-rekey-interval before the software upgrade using the following commands:

```

Tue Nov 26 12:41:01.768 IST
RP/0/RP0/CPU0:ios(config)#otnsec policy OP1
RP/0/RP0/CPU0:ios(config-otnsec-policy)#no sak-rekey-interval

```

The sak-rekey-interval can be configured again after the upgrade process is complete.

---

## Configuring the GCC Interface

To configure the GCC interface, use the following commands:

**config**

**interface GCC2 R/S/I/P**

**ipv4 address ipv4-address**

The following sample displays how to configure the GCC2 interface.

```
RP/0/RP0/CPU0:ios#config
Tue Mar 12 12:06:32.547 UTC
RP/0/RP0/CPU0:ios(config)#controller odu4 0/1/0/0/1
RP/0/RP0/CPU0:ios(config-odu4)#gcc2
RP/0/RP0/CPU0:ios(config-odu4)#commit
RP/0/RP0/CPU0:ios(config-odu4)#exit

RP/0/RP0/CPU0:ios#config
Tue Mar 12 11:16:04.749 UTC
RP/0/RP0/CPU0:ios(config)#interface GCC2 0/1/0/0/1
P/0/RP0/CPU0:ios(config-if)#ipv4 address 10.1.1.1 255.255.255.0
RP/0/RP0/CPU0:ios(config-if)#commit
Tue Mar 12 11:18:32.867 UTC
RP/0/RP0/CPU0:ios(config-if)#exit
RP/0/RP0/CPU0:ios(config)#exit
RP/0/RP0/CPU0:ios#sh run interface gcc2 0/1/0/0/1
Tue Mar 12 11:19:00.475 UTC
interface GCC20/1/0/0/1
  ipv4 address 10.1.1.1 255.255.255.0
!

RP/0/RP0/CPU0:ios#config
Wed Sep 28 23:10:28.258 UTC
RP/0/RP0/CPU0:ios(config)#controller ODU4 0/0/0/12
RP/0/RP0/CPU0:ios(config-oduc4)#gcc2
RP/0/RP0/CPU0:ios(config-oduc4)#commit
RP/0/RP0/CPU0:ios(config-oduc4)#exit

RP/0/RP0/CPU0:ios#config
Wed Sep 28 23:10:29.808 UTC
RP/0/RP0/CPU0:ios(config)#interface GCC2 0/0/0/12
P/0/RP0/CPU0:ios(config-if)#ipv4 address 10.1.1.1 255.255.255.0
RP/0/RP0/CPU0:ios(config-if)#commit
Wed Sep 28 23:10:30.260 UTC UTC
RP/0/RP0/CPU0:ios(config-if)#exit
RP/0/RP0/CPU0:ios(config)#exit
RP/0/RP0/CPU0:ios#sh run interface gcc2 0/0/0/12
Tue Mar 12 11:19:00.475 UTC
interface GCC20/0/0/12
  ipv4 address 10.1.1.1 255.255.255.0
!
```

## Configuring OTNSec on ODU4 Controllers

To configure the OTNSec on ODU4 controller, use the following commands:

**config**

**controller ODU4 rack/slot/instance/port**

**otnsec**

```

source ipv4 ipv4-address
destination ipv4 ipv4-address
session-id session-id
policy policy-name
ikev2 profile-name

```



**Note** The session ID ranges 1–65535.

The following sample displays how to configure OTNSec on the ODU4 controller.

```

RP/0/RP0/CPU0:ios#configure
Mon Mar 12 12:10:21.374 UTC
RP/0/RP0/CPU0:ios(config)#controller ODU4 0/1/0/0/1
RP/0/RP0/CPU0:ios(config-odu4)#otnsec
RP/0/RP0/CPU0:ios(config-otnsec)#source ipv4 10.1.1.1
RP/0/RP0/CPU0:ios(config-otnsec)#destination ipv4 10.1.1.2
RP/0/RP0/CPU0:ios(config-otnsec)#session-id 9000
RP/0/RP0/CPU0:ios(config-otnsec)#policy otnsec-policy1
RP/0/RP0/CPU0:ios(config-otnsec)#ikev2 profile1
RP/0/RP0/CPU0:ios(config-otnsec)#commit
Mon Mar 12 12:14:17.609 UTC
RP/0/RP0/CPU0:ios(config-otnsec)#exit
RP/0/RP0/CPU0:ios(config)#exit

```

## Configuration Example

In the following example, there are two nodes. The node with the lower IP address always acts as the initiator. In this case, node A (SITE-A) has the role of an initiator while Node B (SITE-B) has the role of a responder. In this example, the default IKE proposal and policy have been used on both nodes.

**Figure 4: Configuration Schema**



The configuration on Node A is displayed below.

### Node A (Initiator)

#### Keyring

<p><b>Node A (Initiator)</b></p> <pre>RP/0/RP0/CPU0:SITE-A#configure RP/0/RP0/CPU0:SITE-A(config)#keyring KR1 RP/0/RP0/CPU0:SITE-A(config-keyring-KR1)#peer SITE-B RP/0/RP0/CPU0:SITE-A(config-keyring-KR1-peer-SITE-B)#address 10.1.1.2 255.255.255.0 RP/0/RP0/CPU0:SITE-A(config-keyring-KR1-peer-SITE-B)#pre-shared-key password 106D000A064743595 RP/0/RP0/CPU0:SITE-A(config-keyring-KR1-peer-SITE-B)#commit RP/0/RP0/CPU0:SITE-A(config-keyring-KR1-peer-SITE-B)#exit RP/0/RP0/CPU0:SITE-A(config-keyring-KR1)#exit</pre>
<p><b>IKEv2 profile</b></p> <pre>RP/0/RP0/CPU0:SITE-A(config)#ikev2 profile IP1 RP/0/RP0/CPU0:SITE-A(config-ikev2-profile-IP1)#match identity remote address 10.1.1.2 255.255.255.0 RP/0/RP0/CPU0:SITE-A(config-ikev2-profile-IP1)#keyring KR1 RP/0/RP0/CPU0:SITE-A(config-ikev2-profile-IP1)#lifetime 600 RP/0/RP0/CPU0:SITE-A(config-ikev2-profile-IP1)#commit RP/0/RP0/CPU0:SITE-A(config-ikev2-profile-IP1)#exit</pre>
<p><b>OTNSec policy</b></p> <pre>RP/0/RP0/CPU0:SITE-A(config)#otnsec policy OP1 RP/0/RP0/CPU0:SITE-A(config-otnsec-policy)#cipher-suite AES-GCM-256 RP/0/RP0/CPU0:SITE-A(config-otnsec-policy)#security-policy must-secure RP/0/RP0/CPU0:SITE-A(config-otnsec-policy)#sak-rekey-interval 120 RP/0/RP0/CPU0:SITE-A(config-otnsec-policy)#commit RP/0/RP0/CPU0:SITE-A(config-otnsec-policy)#exit</pre>
<p><b>GCC interface</b></p> <pre>RP/0/RP0/CPU0:SITE-A(config)#controller odu4 0/1/0/0/1 RP/0/RP0/CPU0:SITE-A(config-odu4)#gcc2 RP/0/RP0/CPU0:SITE-A(config-odu4)#commit RP/0/RP0/CPU0:SITE-A(config-odu4)#exit RP/0/RP0/CPU0:SITE-A(config)#interface GCC2 0/1/0/0/1 RP/0/RP0/CPU0:SITE-A(config-if)#ipv4 address 10.1.1.1 255.255.255.0 RP/0/RP0/CPU0:SITE-A(config-if)#commit RP/0/RP0/CPU0:SITE-A(config-if)#exit</pre>
<p><b>OTNSec on ODU4 controller</b></p> <pre>RP/0/RP0/CPU0:SITE-A(config)#controller odu4 0/1/0/0/1 RP/0/RP0/CPU0:SITE-A(config-odu4)#otnsec RP/0/RP0/CPU0:SITE-A(config-otnsec)#source ipv4 10.1.1.1 RP/0/RP0/CPU0:SITE-A(config-otnsec)#destination ipv4 10.1.1.2 RP/0/RP0/CPU0:SITE-A(config-otnsec)#session-id 9000 RP/0/RP0/CPU0:SITE-A(config-otnsec)#policy OP1 RP/0/RP0/CPU0:SITE-A(config-otnsec)#ikev2 IP1 RP/0/RP0/CPU0:SITE-A(config-otnsec)#commit RP/0/RP0/CPU0:SITE-A(config-otnsec)#exit RP/0/RP0/CPU0:SITE-A(config-odu4)#exit RP/0/RP0/CPU0:SITE-B(config)#exit</pre>

The configuration on Node B is displayed below.



<b>Node B (Responder)</b>
<b>Keyring</b>
<pre>RP/0/RP0/CPU0:SITE-B#configure RP/0/RP0/CPU0:SITE-B(config)#keyring KR1 RP/0/RP0/CPU0:SITE-B(config-keyring-KR1)#peer SITE-A RP/0/RP0/CPU0:SITE-B(config-keyring-KR1-peer-SITE-A)#address 10.1.1.1 255.255.255.0 RP/0/RP0/CPU0:SITE-B(config-keyring-KR1-peer-SITE-A)#pre-shared-key password 14341B180F547B7977 RP/0/RP0/CPU0:SITE-B(config-keyring-KR1-peer-SITE-A)#commit RP/0/RP0/CPU0:SITE-B(config-keyring-KR1-peer-SITE-A)#exit RP/0/RP0/CPU0:SITE-B(config-keyring-KR1)#exit</pre>
<b>IKEv2 profile</b>
<pre>RP/0/RP0/CPU0:SITE-B(config)#ikev2 profile IP1 RP/0/RP0/CPU0:SITE-B(config-ikev2-profile-IP1)#match identity remote address 10.1.1.1 255.255.255.0 RP/0/RP0/CPU0:SITE-B(config-ikev2-profile-IP1)#keyring KR1 RP/0/RP0/CPU0:SITE-B(config-ikev2-profile-IP1)#lifetime 600 RP/0/RP0/CPU0:SITE-B(config-ikev2-profile-IP1)#commit RP/0/RP0/CPU0:SITE-B(config-ikev2-profile-IP1)#exit</pre>
<b>OTNSec policy</b>
<pre>RP/0/RP0/CPU0:SITE-B(config)#otnsec policy OP1 RP/0/RP0/CPU0:SITE-B(config-otnsec-policy)#cipher-suite AES-GCM-256 RP/0/RP0/CPU0:SITE-B(config-otnsec-policy)#security-policy must-secure RP/0/RP0/CPU0:SITE-B(config-otnsec-policy)#sak-rekey-interval 120 RP/0/RP0/CPU0:SITE-B(config-otnsec-policy)#commit RP/0/RP0/CPU0:SITE-B(config-otnsec-policy)#exit</pre>
<b>GCC interface</b>
<pre>RP/0/RP0/CPU0:SITE-B(config)#controller odu4 0/1/0/0/1 RP/0/RP0/CPU0:SITE-B(config-odu4)#gcc2 RP/0/RP0/CPU0:SITE-B(config-odu4)#commit RP/0/RP0/CPU0:SITE-B(config-odu4)#exit RP/0/RP0/CPU0:SITE-B(config)#interface GCC2 0/1/0/0/1 RP/0/RP0/CPU0:SITE-B(config-if)#ipv4 address 10.1.1.2 255.255.255.0 RP/0/RP0/CPU0:SITE-B(config-if)#commit RP/0/RP0/CPU0:SITE-B(config-if)#exit</pre>
<b>GCC interface for OTN-XP card</b>
<pre>RP/0/RP0/CPU0:SITE-B(config)#controller oduc4 0/0/0/12 RP/0/RP0/CPU0:SITE-B(config-oduc4)#gcc2 RP/0/RP0/CPU0:SITE-B(config-oduc4)#commit RP/0/RP0/CPU0:SITE-B(config-oduc4)#exit RP/0/RP0/CPU0:SITE-B(config)#interface GCC2 0/0/0/12 RP/0/RP0/CPU0:SITE-B(config-if)#ipv4 address 10.1.1.2 255.255.255.0 RP/0/RP0/CPU0:SITE-B(config-if)#commit RP/0/RP0/CPU0:SITE-B(config-if)#exit</pre>
<b>OTNSec on ODU4 controller</b>

<p><b>Node B (Responder)</b></p> <pre>RP/0/RP0/CPU0:SITE-B(config)#controller odu4 0/1/0/0/1 RP/0/RP0/CPU0:SITE-B(config-odu4)#otnsec RP/0/RP0/CPU0:SITE-B(config-otnsec)#source ipv4 10.1.1.2 RP/0/RP0/CPU0:SITE-B(config-otnsec)#destination ipv4 10.1.1.1 RP/0/RP0/CPU0:SITE-B(config-otnsec)#session-id 9000 RP/0/RP0/CPU0:SITE-B(config-otnsec)#policy OP1 RP/0/RP0/CPU0:SITE-B(config-otnsec)#ikev2 IP1 RP/0/RP0/CPU0:SITE-B(config-otnsec)#commit RP/0/RP0/CPU0:SITE-B(config-otnsec)#exit RP/0/RP0/CPU0:SITE-B(config-odu4)#exit RP/0/RP0/CPU0:SITE-B(config)#exit</pre>
<p><b>OTNSec on ODU4 controller</b></p> <pre>RP/0/RP0/CPU0:SITE-B(config)#controller oduc4 0/0/0/12 RP/0/RP0/CPU0:SITE-B(config-oduc4)#otnsec RP/0/RP0/CPU0:SITE-B(config-otnsec)#source ipv4 10.1.1.2 RP/0/RP0/CPU0:SITE-B(config-otnsec)#destination ipv4 10.1.1.1 RP/0/RP0/CPU0:SITE-B(config-otnsec)#session-id 99 RP/0/RP0/CPU0:SITE-B(config-otnsec)#policy OP1 RP/0/RP0/CPU0:SITE-B(config-otnsec)#ikev2 IP1 RP/0/RP0/CPU0:SITE-B(config-otnsec)#commit RP/0/RP0/CPU0:SITE-B(config-otnsec)#exit RP/0/RP0/CPU0:SITE-B(config-oduc4)#exit RP/0/RP0/CPU0:SITE-B(config)#exit</pre>

# Verification

- Verify that there are no alarms on the ports of the NCS 1004.
- Use the **show** commands listed in the table below to verify the IKEv2 and OTNSec configuration. For details of these commands, see the *Command Reference for Cisco NCS 1004*.

**Table 25: Show Commands**

Show Commands	Purpose
show run ikev2	Displays the running configuration of IKEv2
show ikev2 session	Displays the child SAs created for the session
show ip interface brief	Displays the status of the GCC interfaces
show run controller ODU4 0/1/0/0/1	Displays the running configuration of the ODU4 controller
show controllers ODU4 0/1/0/0/1 otnsec	Displays the OTNSec configuration on the ODU4 controller

Show Commands	Purpose
<pre>show controllers ODU4 0/1/0/0/1 pm current 15-min otnsec</pre>	Displays the PM statistics that help verify the encrypted and decrypted blocks.

## Troubleshooting

**Problem:** The IKE session is not established between the two nodes.

**Solution:** Check the status of the GCC interface using the **show ip interface brief** command.

To gather logs and traces, use the **show tech-support ncs1004 detail**, **show tech-support ikev2**, and **show tech-support otnsec** commands.

## IKEv2 Certificate-Based Authentication

IKEv2 can use RSA digital signatures to authenticate peer devices before setting up SAs. RSA signatures employ a PKI-based method of authentication.

Certification Authority (CA) interoperability permits Cisco NCS 1004 devices and CAs to communicate so that your device can obtain and use digital certificates from the CA. A CA is responsible for managing certificate requests and issuing certificates to participating network devices. With a CA, a router authenticates itself to the remote router by sending a certificate to the remote router and performing some public key cryptography. Each router must send its own unique certificate that was issued and validated by the CA. This process works because the certificate of each router encapsulates the public key of the router, each certificate is authenticated by the CA, and all participating routers recognize the CA as an authenticating authority. This scheme is called IKE with an RSA signature.

In public key cryptography, such as the RSA encryption system, each user has a key pair containing both a public and a private key. The keys act as complements, and anything encrypted with one of the keys can be decrypted with the other. In simple terms, a signature is formed when data is encrypted with a user's private key. The receiver verifies the signature by decrypting the message with the sender's public key. The fact that the message could be decrypted using the sender's public key indicates that the holder of the private key, the sender, must have created the message. This process relies on the receiver's having a copy of the sender's public key and knowing with a high degree of certainty that it does belong to the sender and not to someone pretending to be the sender.

## Configuring IKEv2 Certificate-Based Authentication

To configure IKEv2 certificate-based authentication, perform the following steps:

1. Configure router hostname and IP domain name—You must configure the hostname and IP domain name of the router if they have not already been configured. The hostname and IP domain name are required because the router assigns a fully qualified domain name (FQDN) to the keys and certificates used by OTNsec, and the FQDN is based on the hostname and IP domain name you assign to the router.

**configure**

**hostname** name

**domain name** domain-name

**commit**

```
RP/0/RP0/CPU0:ios#configure
RP/0/RP0/CPU0:IOS(config)#hostname myhost
RP/0/RP0/CPU0:IOS(config)#domain name mydomain.com
RP/0/RP0/CPU0:IOS(config)#commit
```

2. Generate RSA key pair—The RSA key pair is required before you can obtain a certificate for your router.

**crypto key generate rsa *keypair-label***

```
RP/0/RP0/CPU0:ios#crypto key generate rsa tp
Thu May  7 16:18:44.243 IST
The name for the keys will be: tp
Do you really want to replace them? [yes/no]: yes
  Choose the size of the key modulus in the range of 512 to 4096 for your General Purpose Keypair. Choosing a key modulus greater than 512 may take a few minutes.
```

```
How many bits in the [2048]:
Generating RSA keys ...
Done w/ crypto generate keypair
[OK]
```

```
RP/0/RP0/CPU0:ios#show crypto key mypubkey rsa
Thu May  7 16:19:06.606 IST
Key label: tp
Type      : RSA General purpose
Size      : 2048
Created   : 16:18:49 IST Thu May 07 2020
Data      :
30820122 300D0609 2A864886 F70D0101 01050003 82010F00 3082010A 02820101
00CAC6E9 737D5ACF 31D0F8F2 281A450C 4F251D95 53587BCA 13592991 0AF2E6AF
02A89439 1DEDA683 C467C55F 032F05F3 A72DDED9 323F171A FDDEE3C4 DC124439
A78652F6 BB97BE63 F5AC8E3B 03B9B141 DD5D1AAE E41D7C15 28DE96E4 D3F4CE33
B12C477A 525CDBF6 17B92A8C E94A816E 7C4BCEFA 0EA7972D A3B0CBF1 A1DED71E
36CE08B7 3EF477A7 7B875BE1 E1B9E3A8 1E6C2717 6AB6D5AE 3A11D200 B32F4CCB
0B4163A4 E44D5729 70ECFEE6 4713D1CC 588C8AFB D3EE9891 B27BCA5B 8CD82B76
C278B32C 9A24B2EA 0CB9F2F3 6D1A1C95 044106F6 7E71520E B0201414 1E15B1C8
A88E4164 F3474B66 86CF4DFB 8B0DA66C 8C80C8BF EF192CC8 F85FBF71 D1A35B7A
05020301 0001
```

3. Declare a Certification Authority and configure a trustpoint.

**configure**

```
crypto ca trustpoint {ca-name}
```

```
enrollment url {ca-url}
```

```
subject-name {x.500-name}
```

```
serial-number
```

```
rsakeypair {keypair-label}
```

```
crl optional
```

```
ip-address ip-address
```

**commit**

```
RP/0/RP0/CPU0:ios#configure
RP/0/RP0/CPU0:ios (config)# crypto ca trustpoint myca

RP/0/RP0/CPU0:ios (config-trustp)# enrollment url http://209.165.200.226
```

```
RP/0/RP0/CPU0:ios(config-trustp)# subject-name CN=ncs,OU=BU,O=Govt,L=Newyork,ST=NY,C=US

RP/0/RP0/CPU0:ios(config-trustp)#serial-number
RP/0/RP0/CPU0:ios(config-trustp)# rsakeypair tp

RP/0/RP0/CPU0:ios(config-trustp)# crl optional
RP/0/RP0/CPU0:ios(config-trustp)# ip-address 10.105.57.100

RP/0/RP0/CPU0:ios(config-trustp)# commit
```

4. **Authenticate the CA**—The router must authenticate the CA by obtaining the self-signed certificate of the CA, which contains the public key of the CA. Because the certificate of the CA is self-signed (the CA signs its own certificate), manually authenticate the public key of the CA by contacting the CA administrator to compare the fingerprint of the CA certificate.

#### **crypto ca authenticate ca-name**

```
RP/0/RP0/CPU0:ios#crypto ca authenticate myca
Thu May 7 16:20:08.458 IST
  Serial Number   : 01
    CN=ncs,OU=BU,O=Govt,L=Newyork,ST=NY,C=US
  Issued By      :
    CN=ncs,OU=BU,O=Govt,L=Newyork,ST=NY,C=US
  Validity Start : 11:55:46 UTC Wed Jan 08 2020
  Validity End   : 11:55:46 UTC Sat Jan 07 2023
  SHA1 Fingerprint:
    70562AA850DE24B2D94AACF62528042E53C33D23
Do you accept this certificate? [yes/no]: yes
```

5. **Request Device Certificates**—You must obtain a signed certificate from the CA for each of your router's RSA key pairs.

#### **crypto ca enroll ca-name**

```
RP/0/RP0/CPU0:ios#crypto ca enroll myca
Thu May 7 16:20:34.776 IST
% Start certificate enrollment ...
% Create a challenge password. You will need to verbally provide this
  password to the CA Administrator in order to revoke your certificate.
% For security reasons your password will not be saved in the configuration.
% Please make a note of it.

Password:
Re-enter Password:

% The subject name in the certificate will include:
CN=ncs,OU=BU,O=Govt,L=Newyork,ST=NY,C=US
% The subject name in the certificate will include: myhost.mydomain.com
% The serial number in the certificate will be: 93f379c1
% The IP address in the certificate is 10.105.57.100
  Fingerprint: 41304434 42393333 45314143 42443134
```

6. **Verify CA certificate.**

#### **show crypto ca certificates certificate-name**

```
RP/0/RP0/CPU0:ios#show crypto ca certificates myca
Thu May 7 16:21:24.633 IST

Trustpoint      : myca
=====
CA certificate
  Serial Number : 01
  Subject:
```

```

        CN=ncs,OU=BU,O=Govt,L=Newyork,ST=NY,C=US
    Issued By      :
        CN=ncs,OU=BU,O=Govt,L=Newyork,ST=NY,C=US
    Validity Start : 11:55:46 UTC Wed Jan 08 2020
    Validity End   : 11:55:46 UTC Sat Jan 07 2023
    SHA1 Fingerprint:
        70562AA850DE24B2D94AACF62528042E53C33D23
Router certificate
    Key usage      : General Purpose
    Status         : Available
    Serial Number  : 08:4D
    Subject:
        serialNumber=93f379c1,unstructuredAddress=10.105.57.100,
unstructuredName=myhost.mydomain.com,CN=ncs,OU=BU,O=Govt,
L=Newyork,ST=NY,C=US
    Issued By      :
        CN=ncs,OU=BU,O=Govt,L=Newyork,ST=NY,C=US
    Validity Start : 10:44:51 UTC Thu May 07 2020
    Validity End   : 10:44:51 UTC Fri May 07 2021

    CRL Distribution Point
        http://7200.cisco.com
    SHA1 Fingerprint:
        C9454B6DD92A057A1DDB60740E0459243B070B24
Associated Trustpoint: myca

```

7. Configure IKEv2 profile.

**config**

**ikev2 profile** *profile-name*

**match identity remote address** *{ipv4-address [mask]}*

**pki trustpoint** *trustpoint-label*

**lifetime** *seconds*

**authentication local** *rsa-signature*

**authentication remote** *rsa-signature*

**commit**

```

RP/0/RP0/CPU0:ios#configure
Thu May  7 16:22:33.804 IST
RP/0/RP0/CPU0:ios(config)#ikev2 profile IP1
RP/0/RP0/CPU0:ios(config-ikev2-profile-IP1)#match identity remote address 10.1.1.2
255.255.255.255
RP/0/RP0/CPU0:ios(config-ikev2-profile-IP1)#pki trustpoint myca
RP/0/RP0/CPU0:ios(config-ikev2-profile-IP1)#lifetime 120
RP/0/RP0/CPU0:ios(config-ikev2-profile-IP1)#authentication local rsa-signature
RP/0/RP0/CPU0:ios(config-ikev2-profile-IP1)#authentication remote rsa-signature
RP/0/RP0/CPU0:ios(config-ikev2-profile-IP1)#commit

```

8. Configure the GCC2 interface. See [Configuring the GCC Interface, on page 180](#).

9. Configure OTNsec on ODU4 controller.

**config**

**controller ODU4** *R/S/I/P*

**otnsec**

**source ipv4** *ipv4-address*

**destination** *ipv4 ipv4-address*

**session-id** *session-id*

**policy** *policy-name*

**ikev2** *profile-name*

```
RP/0/RP0/CPU0:ios#configure
Thu May 7 16:27:57.294 IST
RP/0/RP0/CPU0:ios(config)#controller ODU4 0/1/0/0/1
RP/0/RP0/CPU0:ios(config-odu4)#otnsec
RP/0/RP0/CPU0:ios(config-otnsec)#source ipv4 10.1.1.1
RP/0/RP0/CPU0:ios(config-otnsec)#destination ipv4 10.1.1.2
RP/0/RP0/CPU0:ios(config-otnsec)#session-id 1
RP/0/RP0/CPU0:ios(config-otnsec)#policy OP1
RP/0/RP0/CPU0:ios(config-otnsec)#ikev2 IP1
RP/0/RP0/CPU0:ios(config-otnsec)#commit
```

## 10. Verify the IKEv2 session.

```
RP/0/RP0/CPU0:ios#show ikev2 session
Wed Sep 22 21:09:38.363 IST
```

```
Session ID                               : 4
=====
Status                                   : UP-ACTIVE
IKE Count                                 : 1
Child Count                              : 1
IKE SA ID                                 : 373
-----
Local                                     : 10.1.1.1/500
Remote                                    : 10.1.1.2/500
Status (Description)                     : READY (Negotiation done)
Role                                      : Initiator

Child SA
-----
Local Selector                           : 10.1.1.1/1 - 10.1.1.1/1
Remote Selector                           : 10.1.1.2/1 - 10.1.1.2/1
ESP SPI IN/OUT                            : 0x2803 / 0x2800
```

```
RP/0/RP0/CPU0:ios#show ikev2 summary
Wed Sep 22 21:09:42.354 IST
```

```
IKEv2 SA Summary
-----
Total SA (Active/Negotiating)           : 1 (1/0)
Total Outgoing SA (Active/Negotiating)   : 1 (1/0)
Total Incoming SA (Active/Negotiating)   : 0 (0/0)
```

## You May Be Interested In

- For more information about IKEv2, see [RFC 7296](#).
- For more information about NCS 1004, see the [NCS 1004 datasheet](#).







## CHAPTER 7

# GMPLS UNI for Packet and Optical Integration

With the cloud becoming increasingly central to business operations, packet and optical network services must evolve to become more efficient and dynamic. Closer integration of packet and optical networks becomes critical especially in the control plane.

- [Understanding GMPLS UNI, on page 191](#)
- [Use Case Overview, on page 192](#)
- [Prerequisites, on page 192](#)
- [Limitations, on page 193](#)
- [Configuration Workflow, on page 193](#)
- [Verification, on page 202](#)
- [General Troubleshooting, on page 209](#)
- [You May Be Also Interested In, on page 209](#)

## Understanding GMPLS UNI

Generalized Multiprotocol Label Switching (GMPLS) User Network Interface (UNI) or GMPLS UNI is a key technology that enables this integration. GMPLS UNI enables packet networks to directly tap into the optical transport control plane to coordinate its resource requirements with the optical transport network. Leveraging open standards, GMPLS UNI optimizes network resources and improves network utilization across packet and optical networks.

### Channel Spacing

DWDM grid in the optical spectrum can be divided into multiple channels so that each channel can carry traffic independently. The number of channels that we receive from the DWDM grid depends on the channel spacing. For example, the lower the channel spacing, the higher the number of channels, and also conversely.

GMPLS has two types of channel spacing:

- Fixed Grid channel spacing - The channel spacing is fixed to 50 GHz and supports 100 and 200-Gbps traffic.
- Flexible Grid channel spacing - The channel spacing is 6.25 GHz and supports all data rates.

The **neighbor flexi-grid-capable** command enables GMPLS UNI flexible grid channel spacing. This command is executed during the [Configure LMP on Cisco NCS 1004 Node](#) configuration.

## Use Case Overview

GMPLS UNI technology addresses the following customer needs in packet and optical networks:

- Effective usage of the DWDM grid with minimal wastage of spectral bandwidth
- Transmission of mixed bit-rate or mixed modulation data in a grid with different channel widths

To address these needs, you create a tunnel between two NCS 1004 nodes to carry traffic using the GMPLS UNI technology as shown in the following figure.

**Figure 5: GMPLS UNI Reference Model**

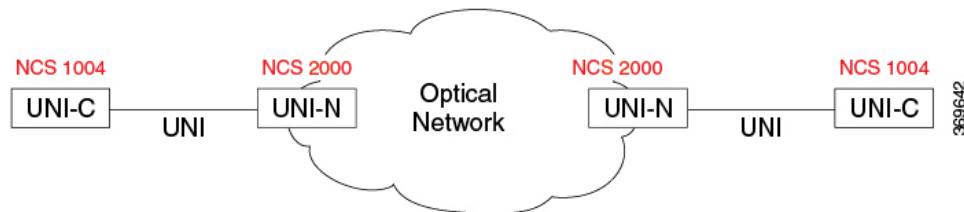

UNI-C is the client or packet or router node; for example, NCS 1004 nodes. UNI-N is the network or optical node; for example, NCS 2000 nodes.

The Link Management Protocol (LMP) link is created to establish connectivity between a NCS 2000 node and a NCS 1004 node. The tunnel is then created between the trunk interfaces of the source and destination NCS 1004 nodes to carry traffic. When the tunnel is created between NCS 1004 nodes, a circuit is internally created between the NCS 2000 nodes. The circuit is created to perform path computation, restoration, and reversion functions.

The tunnel can be created between the source and destination NCS 1004 nodes without involving NCS 2000 nodes in the middle. However, the restoration and reversion capabilities are provided only by the NCS 2000 nodes using GMPLS UNI.

## Prerequisites

Before you create a tunnel using GMPLS UNI, fulfill these prerequisites:

- NCS 1004 node must have both the MPLS and MPLS-TE packages. The package names are ncs1004-mpls and ncs1004-mpls-te-rsvp.
- NCS 2000 node must have a valid license for ROADM and WSON support.
- The management IP addresses of NCS 1004 and NCS 2000 nodes must be accessible.
- The administrative state of the trunk port of the optics controller on the NCS 1004 node must not be in the shutdown state.

# Limitations

## Configuration Workflow

Perform the following tasks in sequence to create a tunnel using GMPLS UNI:

### Configurations on the NCS 2000 node:

1. GMPLS signaled LMP circuit creation.
  - [Configure LMP and Alien Wavelength on NCS 2000 Node Using CTC](#) , on page 193
2. [Retrieve Ifindex from NCS 2000 Node](#), on page 198

### Configurations on the node:

1. Configure LMP on Cisco NCS 1002 Node.
  - [Configure LMP on Cisco NCS 1004 Node](#) , on page 198
2. [Configure RSVP on NCS 1004 Node](#), on page 200
3. Configure MPLS Tunnel on a NCS 1002 Node.
  - [Configure MPLS Tunnel on a NCS 1004 Node for Numbered Circuit](#), on page 201

## Configure LMP and Alien Wavelength on NCS 2000 Node Using CTC

This procedure creates a static LMP link to establish connectivity between a NCS 2000 node and a NCS 1004 node. The LMP creation wizard in CTC provides the capability to select source and destination endpoints of the LMP link, optical parameters, and alien wavelength settings.

### Procedure

- 
- Step 1** From the **View** menu, choose **Go to Network View**.
  - Step 2** Click the **Provisioning > LMP** tabs.
  - Step 3** Click **Create**.  
The LMP Creation window appears.
  - Step 4** Click **Signaled** in the **Router Not Managed by CTC** area.  
A wizard appears with the following options:  
**LMP Origination, LMP Termination, Optical Parameters, and Alien Wavelength**
  - Step 5** In the LMP Origination screen of the wizard, provision these parameters:
    - From the **Originating Node** drop-down list, choose the source node of the LMP.

If the source node is Cisco NCS 1004, the destination node must be MSTP, and the other way round.

- From the **Local Interfaces** drop-down list, choose an available interface.
- Choose the Type, Shelf, Slot, and Port for Ingress Port Selection and Egress Port Selection.
- Choose **Numbered** interface.
- Enter the IP address of the source node in the **Interface IP** field.
- Set the mode of revertive restoration to either UNI-C or UNI-N. If the mode is set to UNI-C, the reversion of the circuit from the restored path to the original path is initiated by the UNI client that is connected to NCS 1004. If the mode is set to UNI-N, the reversion of the circuit is initiated by the DWDM network and can either be a manual revert or an auto revert.
- Enter the RSVP signaling interval and RSVP signaling missed values in the respective fields.
- Click **Next**.

**Step 6** In the LMP Termination screen of the wizard, provision these parameters:

- From the **Terminating Node** drop-down list, choose the destination node of the LMP; for example, MSTP node.
- From the **Rx Port Selection** area, perform the following.
  - Choose the card type from the **Type** drop-down list.
  - Choose a shelf from the **Shelf** drop-down list.
  - Choose a source slot from the **Slot** drop-down list
  - Choose a port from the **Port** drop-down list.
- From the **Tx Port Selection** area, perform the following.
  - Choose the card type from the **Type** drop-down list.
  - Choose a shelf from the **Shelf** drop-down list.
  - Choose a destination slot from the **Slot** drop-down list.
  - Choose a port from the **Port** drop-down list
- Enter the IP address of the destination node in the **Interface IP** field.
- Set the mode of revertive restoration to either UNI-C or UNI-N. If the mode is set to UNI-C, the reversion of the circuit from the restored path to the original path is initiated by the UNI client that is connected. If the mode is set to UNI-N, the reversion of the circuit is initiated by the DWDM network and can be either a manual revert or an auto revert.
- Enter the remote Ifindex of NCS 1004 node (in decimals) in the **Remote If Index** field.
- Click **Next**.

**Step 7** In the Optical Parameters screen of the wizard, provision these parameters:

- **Allow Regeneration**—When checked, the computed path traverses through the regeneration site only if the optical validation is not satisfied. You can regenerate a circuit that is created from the UNI interface. If a transparent path is feasible, the regenerator is not used.
- **UNI State**—Choose **Enable** or **Disable** from the UNI State drop-down list.  
The Enable state is used to configure the UNI interface for the circuits to pass through, between the router and the DWDM node. In the Disable state, the interface is configured but not active, and so the circuit activation is rejected. When the status is changed from Enable to Disable, all active circuits on the interface are deleted.
- **Description**—Enter the description of the UNI interface. The description can be up to 256 characters.
- **Label**—Enter an alphanumeric string. This label is a unique circuit identifier.
- **Validation**—Sets the optical validation mode.
  - **Full**—The circuit is created when the circuit validation result is greater than or equal to the acceptance threshold value.
  - **None**—The circuit is created without considering the acceptance threshold value. The Opt Valid column in the Circuits tab displays the value as **Not Valid**.
  - **Inherited**—The restoration circuit inherits the validation and acceptance threshold values from the primary circuit.
- **Acceptance threshold**—Sets the acceptance threshold value for the GMPLS circuit. The circuit is created if the actual acceptance threshold value is greater than, or equal to, the value set in this field.
  - **Green**—Indicates that the channel failure risk is 0%.
  - **Yellow**—Indicates that the channel failure risk is between 0% and 16%.
  - **Orange**—Indicates that the channel failure risk is between 16% and 50%.
  - **Red**—Indicates that the channel failure risk is greater than 50%.
- **Restoration**—Check this check box to enable the restoration of the GMPLS circuits on the UNI interface.
- **Revert**—Check this check box to enable the revert of the GMPLS circuits on the UNI interface.
- **Auto Revert**—Click this radio button to automatically revert the circuit from the restored path to the original path after the failure is fixed, WSON alarms are acknowledged, and the soak time expires.
- **Manual Revert**—Click this radio button to manually revert the circuit from the restored path to the original path after the failure is fixed, the WSON alarms are acknowledged, and the soak time expires.
- **Soak Time**—Enter the time (in hours, minutes, and seconds) in the Soak Time field that the circuit on the restored path waits before moving to the original path after the failure is fixed. The circuit reverts to the original path after the soak time expires. The soak time must be set only if both the **Restoration** and **Revert** check boxes are checked.

**Step 8** Click Next.

**Step 9** In the Alien wavelength screen of the wizard, provision these parameters.

- From the **Alien Wavelength** drop-down list, choose the alien wavelength class.
- From the **Trunk Selection** drop-down list, choose 100G, 200G, or 250G.

- From the **FEC** drop-down list, choose a valid value for forward error correction (FEC) mode. If an invalid FEC value is chosen, LMP link is created; however, the circuit creation fails.
- Click **Finish** to create an LMP link.

The newly created LMP link appears in the LMP table in CTC.

## Configure LMP and Alien Wavelength on NCS 2000 Node Using CTC for Signaled Unnumbered Circuit

This procedure creates a static LMP unnumbered link to establish connectivity between a NCS 2000 node and a NCS 1004 node. The LMP creation wizard in CTC provides the capability to select source and destination endpoints of the LMP link, optical parameters, and alien wavelength settings.

### Procedure

**Step 1** From the **View** menu, choose **Go to Network View**.

**Step 2** Click the **Provisioning > LMP** tabs.

**Step 3** Click **Create**.

The LMP Creation window appears.

**Step 4** Click **Signaled** in the **Router Not Managed by CTC** area.

A wizard appears with the following options:

#### **LMP Origination, LMP Termination, Optical Parameters, and Alien Wavelength**

**Step 5** In the LMP Origination screen of the wizard, provision these parameters:

- From the **Originating Node** drop-down list, choose the source node of the LMP.
- From the **Local Interfaces** drop-down list, choose an available interface.
- Choose the Type, Unit, and Port for Ingress Port Selection and Egress Port Selection.
- Choose **Unnumbered** interface.
- The IP address of the source node selected appears in the **IP** field.
- Set the mode of revertive restoration to UNI-N. If the mode is set to UNI-N, the reversion of the circuit is initiated by the DWDM network and can either be a manual revert or an auto revert.
- Click **Next**.

**Step 6** In the LMP Termination screen of the wizard, provision these parameters:

- From **Interfaces Configuration**:
  - Enter the NCS 1004 system IP address in the **System IP** field.
- Enter the IP address of the source node in the **Communication Channel** field.

- Enter the SNMP Ifindex value of optic trunk in the **Remote If Index** field.
- Click **Next**.

**Step 7** In the Optical Parameters screen of the wizard, provision these parameters:

- **Allow Regeneration**—When checked, the computed path traverses through the regeneration site only if the optical validation is not satisfied. You can regenerate a circuit that is created from the UNI interface. If a transparent path is feasible, the regenerator is not used.
- **UNI State**—Choose **Enable** or **Disable** from the UNI State drop-down list.

The Enable state is used to configure the UNI interface for the circuits to pass through, between the router and the DWDM node. In the Disable state, the interface is configured but not active, and so the circuit activation is rejected. When the status is changed from Enable to Disable, all active circuits on the interface are deleted.
- **Description**—Enter the description of the UNI interface like **Signal Unnumb LMP**. The description can be up to 256 characters.
- **Label**—Enter an alphanumeric string. This label is a unique circuit identifier.
- **Validation**—Sets the optical validation mode.
  - **Full**—The circuit is created when the circuit validation result is greater than or equal to the acceptance threshold value.
  - **None**—The circuit is created without considering the acceptance threshold value. The Opt Valid column in the Circuits tab displays the value as **Not Valid**.
  - **Inherited**—The restoration circuit inherits the validation and acceptance threshold values from the primary circuit.
- **Acceptance Threshold**—Sets the acceptance threshold value for the GMPLS circuit. The circuit is created if the actual acceptance threshold value is greater than, or equal to, the value set in this field.
  - **Green**—Indicates that the channel failure risk is 0%.
  - **Yellow**—Indicates that the channel failure risk is between 0% and 16%.
  - **Orange**—Indicates that the channel failure risk is between 16% and 50%.
  - **Red**—Indicates that the channel failure risk is greater than 50%.
- **Restoration**—Check this check box to enable the restoration of the GMPLS circuits on the UNI interface.
- **Revert**—Check this check box to enable the revert of the GMPLS circuits on the UNI interface.
- **Auto Revert**—Click this radio button to automatically revert the circuit from the restored path to the original path after the failure is fixed, WSON alarms are acknowledged, and the soak time expires.
- **Manual Revert**—Click this radio button to manually revert the circuit from the restored path to the original path after the failure is fixed, the WSON alarms are acknowledged, and the soak time expires.
- **Soak Time**—Enter the time (in hours, minutes, and seconds) in the Soak Time field that the circuit on the restored path waits before moving to the original path after the failure is fixed. The circuit reverts to the original path after the soak time expires. The soak time must be set only if both the **Restoration** and **Revert** check boxes are checked.

**Step 8** Click **Next**.

**Step 9** In the Alien wavelength screen of the wizard, provision these parameters.

- From the **Alien Wavelength** drop-down list, choose the alien wavelength class such as NCS 1004.
- From the **Trunk Selection** drop-down list, choose 100G, 200G, or 250G.
- From the **FEC** drop-down list, choose a valid value for forward error correction (FEC) mode. If an invalid FEC value is chosen, LMP link is created; however, the circuit creation fails.
- Click **Finish** to create an LMP link.

The newly created signaled LMP unnumbered circuit link appears in the LMP table in CTC.

## Retrieve Ifindex from NCS 2000 Node

The Ifindex value of all the LMP ports of NCS 2000 node can be retrieved using CTC or TL1.

### Using CTC:

From the **Provisioning > LMP** tab, retrieve the Ifindex value in decimal format under the **Originating Interface Index** column.

This Ifindex value is used in the **neighbor interface-id unnumbered** command during the [Configure LMP on Cisco NCS 1004 Node](#) configuration.

### Using TL1:

1. Log in to the TL1 interface and issue the following command.
2. **rtrv-unicfg ::all:1;**

This command retrieves the Ifindex of all the LMP ports of NCS 2000 node in hexadecimal format. This must be converted to decimal format and used in remote Ifindex of NCS 1004 node during the [Configure LMP on Cisco NCS 1004 Node](#).

### TL1 Output

```
PSLINE-81-1-9-RX:PSLINE-81-1-9-TX,10.77.142.92,3.3.3.4,3.3.3.3,0.0.0.0,VALMODE=NONE,ADMINSTATE=UP,
RESTTYPE=REVERT,USPWROFS=0.0,
DSPWROFS=0.0,ALLOWREGEN=NO,UNICTRLMODE=CLIENT,REVERTMODE=MANUAL,SOAK=00-01-00,
RESTVALMODE=NONE,TERMINTFDX=0,ORIGINTFIDX=7f000d12,NUMBERED=TRUE,UNIMODE=GMPLS
```

```
PSLINE-81-1-10-RX:PSLINE-81-1-10-TX,10.77.142.92,4.4.4.4,4.4.4.3,0.0.0.0,VALMODE=NONE,ADMINSTATE=UP,
RESTTYPE=REVERT,USPWROFS=0.0,DSPWROFS=0.0,ALLOWREGEN=NO,UNICTRLMODE=CLIENT,
REVERTMODE=MANUAL,SOAK=00-01-00,RESTVALMODE=NONE,TERMINTFDX=0,
ORIGINTFIDX=7f000d14,NUMBERED=TRUE,UNIMODE=GMPLS
```

The Ifindex of port 81-1-9 is 7f000d12 (in hexadecimal) and 2130709778 (in decimal). The Ifindex of port 81-1-10 is 7f000d14 (in hexadecimal) and 2130709780 (in decimal).

## Configure LMP on Cisco NCS 1004 Node

LMP is a logical link that is created on the trunk optics controller of the source and destination NCS 1004 nodes of the tunnel.



```

configure
lmp
gmpls optical-uni
controller optics Rack/Slot/Instance/Port
neighbor name
neighbor link-id ipv4 unicast ipv4-address
neighbor flexi-grid-capable
neighbor interface-id unnumbered interface-id
link-id ipv4 unicast ipv4-address
router-id ipv4 unicast ipv4-address
commit

```

### Important Notes

- **neighbor link-id ipv4 unicast** *ipv4-address* is the IP address of the MSTP interface on the NCS 2000 node.
- **neighbor flexi-grid-capable** enables GMPLS UNI flexible grid channel spacing.
- **neighbor interface-id unnumbered** *interface-id* is the optical interface ID of the neighbor. This value is the Ifindex value of all the LMP ports of NCS 2000 node in decimal format that is manually retrieved from CTC or TL1. See [Retrieve Ifindex from NCS 2000 Node, on page 198](#) to retrieve the Ifindex.
- **link-id ipv4 unicast** *ipv4-address* is the IP address of the optics controller on the current NCS 1004 node.
- **router-id ipv4 unicast** *ipv4-address* is the neighbor router IP address for GMPLS UNI.

### Running Configuration

The following is a sample of configuring LMP on the source NCS 1004 node.

#### show running-config lmp

```

Mon Jul  1 14:42:46.856 IST
lmp
gmpls optical-uni
  controller Optics0/0/0/0
  neighbor ncs1k
  neighbor link-id ipv4 unicast 10.1.1.1
  neighbor flexi-grid-capable
  neighbor interface-id unnumbered 2130706976
  link-id ipv4 unicast 10.0.1.1
!
controller Optics0/0/0/1
  neighbor ncs1k
  neighbor link-id ipv4 unicast 10.1.3.3
  neighbor flexi-grid-capable
  neighbor interface-id unnumbered 2130707232
  link-id ipv4 unicast 10.0.3.3
!
controller Optics0/1/0/0

```

```

neighbor ncs1k
neighbor link-id ipv4 unicast 10.1.4.4
neighbor flexi-grid-capable
neighbor interface-id unnumbered 2130706964
link-id ipv4 unicast 10.0.4.4
!
controller Optics0/1/0/1
neighbor ncs1k
neighbor link-id ipv4 unicast 10.1.5.5
neighbor flexi-grid-capable
neighbor interface-id unnumbered 2130706966
link-id ipv4 unicast 10.0.5.5
!
neighbor ncs1k
ipcc routed
router-id ipv4 unicast 10.127.60.48
!
router-id ipv4 unicast 10.105.57.101
!
!
!

```

The following sample shows the brief summary of the tunnel status and configuration.

#### show mpls traffic-eng tunnels optical-uni brief

Wed Sep 22 17:08:13.132 IST

TUNNEL NAME	DESTINATION	STATUS	STATE
GMPLS-UNI-Optics0/3/0/1	10.24.1.1	up	up
GMPLS-UNI-Optics0/0/0/1	10.34.1.1	up	up

Displayed 2 (of 2) heads, 0 (of 0) midpoints, 0 (of 0) tails  
 Displayed 2 up, 0 down, 0 recovering, 0 recovered heads

## Configure RSVP on NCS 1004 Node

Resource Reservation Protocol (RSVP) with an appropriate timeout must be configured on the source and destination NCS 1004 nodes of the tunnel.

#### configure

#### rsvp

**controller optics** *Rack/Slot/Instance/Port*

**signalling refresh out-of-band interval** *interval*

**signalling refresh out-of-band missed** *mis-count*

#### commit

The following is a sample of configuring RSVP on the source NCS 1004 node.

```

RP/0/RP0/CPU0:ios#configure
RP/0/RP0/CPU0:ios(config)#rsvp
RP/0/RP0/CPU0:ios(config-rsvp)#controller optics 0/0/0/6
RP/0/RP0/CPU0:ios(config-rsvp-cntl)#signalling refresh out-of-band interval 3600
RP/0/RP0/CPU0:ios(config-rsvp-cntl)#signalling refresh out-of-band missed 24
RP/0/RP0/CPU0:ios(config-rsvp-cntl)#commit

```

## Configure MPLS Tunnel on a NCS 1004 Node for Numbered Circuit

Ensure that the administrative state of the trunk port of the optics controller on the NCS 1004 node is not in shutdown state.

```

configure
mpls traffic-eng
gmpls optical-uni
controller optics Rack/Slot/Instance/Port
tunnel-properties
tunnel-id id
destination ipv4 unicast ipv4-address
path-option 10 no-ero lockdown
commit

```

### Important Notes

- **destination ipv4 unicast** *ipv4-address* is the IP address of the optics controller on the destination NCS 1004 node.
- Explicit Route Object (ERO) - Includes one or more routes to use from a list of specified nodes for a tunnel.
- Exclude Route Object (XRO) - Excludes one or more routes to use from a list of specified nodes for a tunnel.

### Running Configuration

The following is a sample of configuring the MPLS tunnel on the source NCS 1004 node.

```

RP/0/RP0/CPU0:ios#configure
RP/0/RP0/CPU0:ios(config)#mpls traffic-eng
RP/0/RP0/CPU0:ios(config-mpls-te)#gmpls optical-uni
RP/0/RP0/CPU0:ios(config-te-gmpls-uni)#controller optics 0/0/0/6
RP/0/RP0/CPU0:ios(config-te-gmpls-ctrl)#tunnel-properties
RP/0/RP0/CPU0:ios(config-te-gmpls-tun)#tunnel-id 100
RP/0/RP0/CPU0:ios(config-te-gmpls-tun)#destination ipv4 unicast 10.20.20.20
RP/0/RP0/CPU0:ios(config-te-gmpls-tun)#path-option 10 no-ero lockdown
RP/0/RP0/CPU0:ios(config-te-gmpls-tun)#commit

```

The following is a sample of configuring the MPLS tunnel on the destination NCS 1004 node.

```

RP/0/RP0/CPU0:ios#configure
RP/0/RP0/CPU0:ios(config)#mpls traffic-eng
RP/0/RP0/CPU0:ios(config-mpls-te)#gmpls optical-uni
RP/0/RP0/CPU0:ios(config-te-gmpls-uni)#controller optics 0/0/0/6
RP/0/RP0/CPU0:ios(config-te-gmpls-uni)#commit

```

# Verification

Use the show commands in the following table to verify the GMPLS UNI tunnel, RSVP, and LMP configuration.

**Table 26: Show Commands**

Show Commands	Description
<b>show mpls traffic-eng link-management optical-uni controller optics</b>	Displays detailed GMPLS information of a specific optics controller.
<b>show mpls traffic-eng link-management optical-uni</b>	Displays detailed GMPLS information of all the optics controllers.
<b>show mpls traffic-eng tunnels</b>	Displays information about tunnels.
<b>show mpls traffic-eng link-management optical-uni tabular</b>	Displays detailed GMPLS information of all the optics controllers in tabular format.
<b>show mpls traffic-eng tunnels tabular</b>	Displays information about all the tunnels in tabular format.
<b>show lmp gmpls optical-uni</b>	Verifies LMP configuration and state.
<b>show rsvp neighbors</b>	Displays information about RSVP neighbors.

## Sample Outputs

**show mpls traffic-eng link-management optical-uni controller optics 0/0/0/13**

Displays detailed GMPLS information of a specific optics controller.

```

Mon Jul 1 20:05:27.209 IST
Optical interface: Optics0/0/0/0
  Overview:
    IM state: Up
    Child interface: : IM state Unknown
    OLM/LMP state: Up
    Optical tunnel state: up
  Connection:
    Tunnel role: Tail
    Tunnel-id: 15, LSP-id 3, Extended tunnel-id 10.105.57.100
    Tunnel source: 10.105.57.100, destination: 10.11.1.1
    Optical router-ids: Local: 10.105.57.101, Remote: 10.127.60.48
    Label source: UNI-N
  Upstream label:
    Optical label:
      Grid           : DWDM
      Channel spacing : 6.25 GHz
      Identifier      : 0
      Channel Number  : -277
  Downstream label:
    Optical label:
      Grid           : DWDM
      Channel spacing : 6.25 GHz
      Identifier      : 0

```

```

Channel Number      : -277
SRLG discovery: Disabled
SRLG announcement: None
Switching Type: lsc
MTU: 9212
Admission Control:
  Upstream: Admitted (LSP ID: 3)
  Downstream: Admitted (LSP ID: 3)
OLM/LMP adjacency information:
  Adjacency status: Up
Local:
  node ID: 10.105.57.101
  link interface ID: 10
  link ID: 10.11.1.1
Neighbor:
  node ID: 10.127.60.48 (VEGA2K-Site-3_48)
  link interface ID: 2130706976
  link ID: 10.1.1.1
  IPCC: Routed to 10.127.60.48
Optical capabilities:
  Controller type: DWDM
  Channel spacing: 6.25 GHz
  Default channel: 0
  784 supported channels:
    -303, -302, -301, -300, -299, -298, -297, -296
    -295, -294, -293, -292, -291, -290, -289, -288
    -287, -286, -285, -284, -283, -282, -281, -280
    -279, -278, -277, -276, -275, -274, -273, -272
    -271, -270, -269, -268, -267, -266, -265, -264
    -263, -262, -261, -260, -259, -258, -257, -256
    -255, -254, -253, -252, -251, -250, -249, -248
    -247, -246, -245, -244, -243, -242, -241, -240
    -239, -238, -237, -236, -235, -234, -233, -232
    -231, -230, -229, -228, -227, -226, -225, -224
    -223, -222, -221, -220, -219, -218, -217, -216
    -215, -214, -213, -212, -211, -210, -209, -208
    -207, -206, -205, -204, -203, -202, -201, -200
    -199, -198, -197, -196, -195, -194, -193, -192
    -191, -190, -189, -188, -187, -186, -185, -184
    -183, -182, -181, -180, -179, -178, -177, -176
    -175, -174, -173, -172, -171, -170, -169, -168
    -167, -166, -165, -164, -163, -162, -161, -160
    -159, -158, -157, -156, -155, -154, -153, -152
    -151, -150, -149, -148, -147, -146, -145, -144
    -143, -142, -141, -140, -139, -138, -137, -136
    -135, -134, -133, -132, -131, -130, -129, -128
    -127, -126, -125, -124, -123, -122, -121, -120
    -119, -118, -117, -116, -115, -114, -113, -112
    -111, -110, -109, -108, -107, -106, -105, -104
    -103, -102, -101, -100, -99, -98, -97, -96
    -95, -94, -93, -92, -91, -90, -89, -88
    -87, -86, -85, -84, -83, -82, -81, -80
    -79, -78, -77, -76, -75, -74, -73, -72
    -71, -70, -69, -68, -67, -66, -65, -64
    -63, -62, -61, -60, -59, -58, -57, -56
    -55, -54, -53, -52, -51, -50, -49, -48
    -47, -46, -45, -44, -43, -42, -41, -40
    -39, -38, -37, -36, -35, -34, -33, -32
    -31, -30, -29, -28, -27, -26, -25, -24
    -23, -22, -21, -20, -19, -18, -17, -16
    -15, -14, -13, -12, -11, -10, -9, -8
    -7, -6, -5, -4, -3, -2, -1, 0
    1, 2, 3, 4, 5, 6, 7, 8
    9, 10, 11, 12, 13, 14, 15, 16

```

```

17, 18, 19, 20, 21, 22, 23, 24
25, 26, 27, 28, 29, 30, 31, 32
33, 34, 35, 36, 37, 38, 39, 40
41, 42, 43, 44, 45, 46, 47, 48
49, 50, 51, 52, 53, 54, 55, 56
57, 58, 59, 60, 61, 62, 63, 64
65, 66, 67, 68, 69, 70, 71, 72
73, 74, 75, 76, 77, 78, 79, 80
81, 82, 83, 84, 85, 86, 87, 88
89, 90, 91, 92, 93, 94, 95, 96
97, 98, 99, 100, 101, 102, 103, 104
105, 106, 107, 108, 109, 110, 111, 112
113, 114, 115, 116, 117, 118, 119, 120
121, 122, 123, 124, 125, 126, 127, 128
129, 130, 131, 132, 133, 134, 135, 136
137, 138, 139, 140, 141, 142, 143, 144
145, 146, 147, 148, 149, 150, 151, 152
153, 154, 155, 156, 157, 158, 159, 160
161, 162, 163, 164, 165, 166, 167, 168
169, 170, 171, 172, 173, 174, 175, 176
177, 178, 179, 180, 181, 182, 183, 184
185, 186, 187, 188, 189, 190, 191, 192
193, 194, 195, 196, 197, 198, 199, 200
201, 202, 203, 204, 205, 206, 207, 208
209, 210, 211, 212, 213, 214, 215, 216
217, 218, 219, 220, 221, 222, 223, 224
225, 226, 227, 228, 229, 230, 231, 232
233, 234, 235, 236, 237, 238, 239, 240
241, 242, 243, 244, 245, 246, 247, 248
249, 250, 251, 252, 253, 254, 255, 256
257, 258, 259, 260, 261, 262, 263, 264
265, 266, 267, 268, 269, 270, 271, 272
273, 274, 275, 276, 277, 278, 279, 280
281, 282, 283, 284, 285, 286, 287, 288
289, 290, 291, 292, 293, 294, 295, 296
297, 298, 299, 300, 301, 302, 303, 304
305, 306, 307, 308, 309, 310, 311, 312
313, 314, 315, 316, 317, 318, 319, 320
321, 322, 323, 324, 325, 326, 327, 328
329, 330, 331, 332, 333, 334, 335, 336
337, 338, 339, 340, 341, 342, 343, 344
345, 346, 347, 348, 349, 350, 351, 352
353, 354, 355, 356, 357, 358, 359, 360
361, 362, 363, 364, 365, 366, 367, 368
369, 370, 371, 372, 373, 374, 375, 376
377, 378, 379, 380, 381, 382, 383, 384
385, 386, 387, 388, 389, 390, 391, 392
393, 394, 395, 396, 397, 398, 399, 400
401, 402, 403, 404, 405, 406, 407, 408
409, 410, 411, 412, 413, 414, 415, 416
417, 418, 419, 420, 421, 422, 423, 424
425, 426, 427, 428, 429, 430, 431, 432
433, 434, 435, 436, 437, 438, 439, 440
441, 442, 443, 444, 445, 446, 447, 448
449, 450, 451, 452, 453, 454, 455, 456
457, 458, 459, 460, 461, 462, 463, 464
465, 466, 467, 468, 469, 470, 471, 472
473, 474, 475, 476, 477, 478, 479, 480
Controller SRLGs
None

```

**show mpls traffic-eng link-management optical-uni**

Displays detailed GMPLS information of all the optics controllers. MPLS tunnels are not created when the optics controller is in the shutdown state. The state is displayed as **Admin down**. Enter the **no shutdown** command under the optics controller to initiate the tunnel creation.

```

Mon Jul  1 20:00:42.108 IST

System Information:
  Optical Links Count: 1 (Maximum Links Supported 100)

Optical interface: Optics0/0/0/0
  Overview:
    IM state: Up
    Child interface: : IM state Unknown
    OLM/LMP state: Up
    Optical tunnel state: up
  Connection:
    Tunnel role: Tail
    Tunnel-id: 15, LSP-id 3, Extended tunnel-id 10.105.57.100
    Tunnel source: 10.105.57.100, destination: 10.11.1.1
    Optical router-ids: Local: 10.105.57.101, Remote: 10.127.60.48
    Label source: UNI-N
  Upstream label:
    Optical label:
      Grid           : DWDM
      Channel spacing : 6.25 GHz
      Identifier      : 0
      Channel Number  : -277
  Downstream label:
    Optical label:
      Grid           : DWDM
      Channel spacing : 6.25 GHz
      Identifier      : 0
      Channel Number  : -277
  SRLG discovery: Disabled
  SRLG announcement: None
  Switching Type: lsc
  MTU: 9212
  Admission Control:
    Upstream: Admitted (LSP ID: 3)
    Downstream: Admitted (LSP ID: 3)
  OLM/LMP adjacency information:
    Adjacency status: Up
  Local:
    node ID: 10.105.57.101
    link interface ID: 10
    link ID: 10.11.1.1
  Neighbor:
    node ID: 10.127.60.48 (VEGA2K-Site-3_48)
    link interface ID: 2130706976
    link ID: 10.1.1.1
    IPCC: Routed to 10.127.60.48
  Optical capabilities:
    Controller type: DWDM
    Channel spacing: 6.25 GHz
    Default channel: 0
  784 supported channels:
    -303, -302, -301, -300, -299, -298, -297, -296
    -295, -294, -293, -292, -291, -290, -289, -288
    -287, -286, -285, -284, -283, -282, -281, -280
    -279, -278, -277, -276, -275, -274, -273, -272
    -271, -270, -269, -268, -267, -266, -265, -264
    -263, -262, -261, -260, -259, -258, -257, -256
    -255, -254, -253, -252, -251, -250, -249, -248

```

-247, -246, -245, -244, -243, -242, -241, -240  
 -239, -238, -237, -236, -235, -234, -233, -232  
 -231, -230, -229, -228, -227, -226, -225, -224  
 -223, -222, -221, -220, -219, -218, -217, -216  
 -215, -214, -213, -212, -211, -210, -209, -208  
 -207, -206, -205, -204, -203, -202, -201, -200  
 -199, -198, -197, -196, -195, -194, -193, -192  
 -191, -190, -189, -188, -187, -186, -185, -184  
 -183, -182, -181, -180, -179, -178, -177, -176  
 -175, -174, -173, -172, -171, -170, -169, -168  
 -167, -166, -165, -164, -163, -162, -161, -160  
 -159, -158, -157, -156, -155, -154, -153, -152  
 -151, -150, -149, -148, -147, -146, -145, -144  
 -143, -142, -141, -140, -139, -138, -137, -136  
 -135, -134, -133, -132, -131, -130, -129, -128  
 -127, -126, -125, -124, -123, -122, -121, -120  
 -119, -118, -117, -116, -115, -114, -113, -112  
 -111, -110, -109, -108, -107, -106, -105, -104  
 -103, -102, -101, -100, -99, -98, -97, -96  
 -95, -94, -93, -92, -91, -90, -89, -88  
 -87, -86, -85, -84, -83, -82, -81, -80  
 -79, -78, -77, -76, -75, -74, -73, -72  
 -71, -70, -69, -68, -67, -66, -65, -64  
 -63, -62, -61, -60, -59, -58, -57, -56  
 -55, -54, -53, -52, -51, -50, -49, -48  
 -47, -46, -45, -44, -43, -42, -41, -40  
 -39, -38, -37, -36, -35, -34, -33, -32  
 -31, -30, -29, -28, -27, -26, -25, -24  
 -23, -22, -21, -20, -19, -18, -17, -16  
 -15, -14, -13, -12, -11, -10, -9, -8  
 -7, -6, -5, -4, -3, -2, -1, 0  
 1, 2, 3, 4, 5, 6, 7, 8  
 9, 10, 11, 12, 13, 14, 15, 16  
 17, 18, 19, 20, 21, 22, 23, 24  
 25, 26, 27, 28, 29, 30, 31, 32  
 33, 34, 35, 36, 37, 38, 39, 40  
 41, 42, 43, 44, 45, 46, 47, 48  
 49, 50, 51, 52, 53, 54, 55, 56  
 57, 58, 59, 60, 61, 62, 63, 64  
 65, 66, 67, 68, 69, 70, 71, 72  
 73, 74, 75, 76, 77, 78, 79, 80  
 81, 82, 83, 84, 85, 86, 87, 88  
 89, 90, 91, 92, 93, 94, 95, 96  
 97, 98, 99, 100, 101, 102, 103, 104  
 105, 106, 107, 108, 109, 110, 111, 112  
 113, 114, 115, 116, 117, 118, 119, 120  
 121, 122, 123, 124, 125, 126, 127, 128  
 129, 130, 131, 132, 133, 134, 135, 136  
 137, 138, 139, 140, 141, 142, 143, 144  
 145, 146, 147, 148, 149, 150, 151, 152  
 153, 154, 155, 156, 157, 158, 159, 160  
 161, 162, 163, 164, 165, 166, 167, 168  
 169, 170, 171, 172, 173, 174, 175, 176  
 177, 178, 179, 180, 181, 182, 183, 184  
 185, 186, 187, 188, 189, 190, 191, 192  
 193, 194, 195, 196, 197, 198, 199, 200  
 201, 202, 203, 204, 205, 206, 207, 208  
 209, 210, 211, 212, 213, 214, 215, 216  
 217, 218, 219, 220, 221, 222, 223, 224  
 225, 226, 227, 228, 229, 230, 231, 232  
 233, 234, 235, 236, 237, 238, 239, 240  
 241, 242, 243, 244, 245, 246, 247, 248  
 249, 250, 251, 252, 253, 254, 255, 256  
 257, 258, 259, 260, 261, 262, 263, 264



```

265, 266, 267, 268, 269, 270, 271, 272
273, 274, 275, 276, 277, 278, 279, 280
281, 282, 283, 284, 285, 286, 287, 288
289, 290, 291, 292, 293, 294, 295, 296
297, 298, 299, 300, 301, 302, 303, 304
305, 306, 307, 308, 309, 310, 311, 312
313, 314, 315, 316, 317, 318, 319, 320
321, 322, 323, 324, 325, 326, 327, 328
329, 330, 331, 332, 333, 334, 335, 336
337, 338, 339, 340, 341, 342, 343, 344
345, 346, 347, 348, 349, 350, 351, 352
353, 354, 355, 356, 357, 358, 359, 360
361, 362, 363, 364, 365, 366, 367, 368
369, 370, 371, 372, 373, 374, 375, 376
377, 378, 379, 380, 381, 382, 383, 384
385, 386, 387, 388, 389, 390, 391, 392
393, 394, 395, 396, 397, 398, 399, 400
401, 402, 403, 404, 405, 406, 407, 408
409, 410, 411, 412, 413, 414, 415, 416
417, 418, 419, 420, 421, 422, 423, 424
425, 426, 427, 428, 429, 430, 431, 432
433, 434, 435, 436, 437, 438, 439, 440
441, 442, 443, 444, 445, 446, 447, 448
449, 450, 451, 452, 453, 454, 455, 456
457, 458, 459, 460, 461, 462, 463, 464
465, 466, 467, 468, 469, 470, 471, 472
473, 474, 475, 476, 477, 478, 479, 480
Controller SRLGs
None
    
```

**show mpls traffic-eng link-management optical-uni tabular**

Displays detailed GMPLS information of all the optics controllers in tabular format.

Mon Jul 1 15:10:50.472 IST

System Information:

Optical Links Count: 4 (Maximum Links Supported 100)

Interface	State		LMP adjacency	GMPLS tunnel		
	Admin	Oper		role	tun-id	state
Op0/0/0/0	up	up	up	Tail	15	up
Op0/0/0/1	up	up	up	Tail	16	up
Op0/1/0/0	up	up	up	Tail	17	up
Op0/1/0/1	up	up	up	Tail	18	up

**show mpls traffic-eng tunnels**

Displays information about tunnels.

Mon Jul 1 15:03:58.490 IST

LSP Tunnel 10.105.57.100 15 [5] is signalled, Signaling State: up

Tunnel Name: ckt0/0/0/0 Tunnel Role: Tail

Upstream label:

Optical label:

```

Grid           : DWDM
Channel spacing : 6.25 GHz
Identifier      : 0
Channel Number  : -277
    
```

Downstream label:

Optical label:

```

Grid                : DWDM
Channel spacing     : 6.25 GHz
Identifier          : 0
Channel Number      : -277
Signalling Info:
Src 10.105.57.100 Dst 10.11.1.1, Tun ID 15, Tun Inst 5, Ext ID 10.105.57.100
Router-IDs: upstream 10.127.60.48
             local   10.105.57.101
Priority: 7 7
SRLGs: not collected
Path Info:
Incoming Address: 10.1.1.1
Incoming:
Explicit Route:
No ERO

Route Exclusions:
No XRO
Record Route: Disabled
Tspec: avg rate=4294967033 kbits, burst=1000 bytes, peak rate=4294967033 kbits
Session Attributes: Local Prot: Not Set, Node Prot: Not Set, BW Prot: Not Set
Resv Info: None
Record Route: Disabled
Espec: avg rate=4294967033 kbits, burst=1000 bytes, peak rate=4294967033 kbits
Displayed 0 (of 0) heads, 0 (of 0) midpoints, 1 (of 1) tails
Displayed 0 up, 0 down, 0 recovering, 0 recovered heads

```

**show rsvp neighbors**

Displays information about RSVP neighbors.

```

Mon Jul 1 14:58:48.888 IST
Global Neighbor: 10.127.60.48
Interface Neighbor  Interface
-----
10.127.60.48      MgmtEth0/RP0/CPU0/0

```

**show lmp gmpls optical-uni**

Verifies LMP configuration and state.

```

Mon Jul 1 14:55:35.492 IST

GMPLS Optical-UNI LMP Router ID: 10.105.57.101

LMP Neighbor
Name: ncslk, IP: 10.127.60.48, Owner: GMPLS Optical-UNI
LMP: Disabled
IPCC ID: 1, State Up
LMP UDP port: 701
Known via      : Configuration
Type           : Routed
Destination IP : 10.127.60.48
Source IP      : 10.105.57.101

```

Interface I/F	Lcl Interface ID	Lcl Link ID	Interface LMP state
Optics0/1/0/1	7	10.0.5.5	Up
Optics0/1/0/0	6	10.0.4.4	Up
Optics0/0/0/1	11	10.0.3.3	Up
Optics0/0/0/0	10	10.11.1.1	Up

## General Troubleshooting

Collect and analyze the output of the following commands for any software issues.

- **show tech-support mpls traffic-eng file** *filename*
- **show tech-support mpls rsvp file** *filename*
- **show lmp clients**
- **show rsvp neighbors**
- **show mpls traffic-eng link-management optical-uni controller optics** *Rack/Slot/Instance/Port*
- **show mpls traffic-eng tunnels** *tunnel-id*

Problem	Solution
When NCS 2000 node cannot route the DWDM wavelength to the destination, it displays a generic error message as <b>No Route to destination</b> .	As a superuser, collect and analyze the diagnostic information by entering the following address at the browser.  <i>http://ip-address-of-head-node/diagnostics/wson</i>

## You May Be Also Interested In

- GMPLS UNI commands: [Cisco IOS XR MPLS Command Reference](#).
- [GMPLS Restoration and Reversion](#)

You May Be Also Interested In



# CHAPTER 8

## Understanding Remote Node Management Using GCC

The remote node management feature allows you to remotely manage NCS 1004 nodes over the General Communication Channel (GCC) interface. The remote nodes that are not connected to the management network over the Ethernet interface can be managed over the GCC interface. This feature supports remote management of up to eight nodes in hub topology and up to two nodes in linear topology.

**Figure 6: Remote Node Management in Linear Topology**

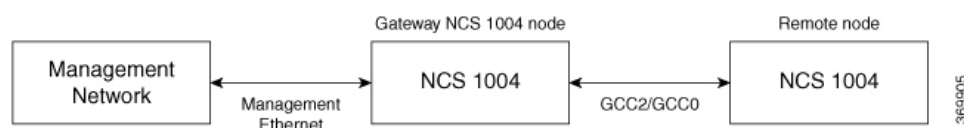

The remote nodes can be dynamically discovered over the GCC interface using OSPF. The connectivity to the management network can be achieved using OSPF and static routes.



**Note** The GCC2 and GCC0 interfaces are supported in NCS 1004. The GCC0 interface is supported on the Coherent DSP controller whereas the GCC2 interface is supported on the ODU controller.



**Note** The GCC0 and GCC2 interfaces are supported in Muxponder and Muxponder slice modes. Only the GCC0 interface is supported in the Regeneration (Regen) mode.

### Remote Node Management on OTN-XP Card

**Table 27: Feature History**

Feature Name	Release Information	Feature Description
GCC Support for OTN-XP Card	Cisco IOS XR Release 7.3.2	The node supports a maximum of 48 GCC (GCC0 and GCC1) channels for each OTN-XP card.

From R7.2.1 onwards, the OTN-XP card provides OTU interface that supports communication channels between adjacent network elements or nodes using GCC bytes in the OTN header. Remote node management is supported over the GCC interface.

From R7.2.1 onwards, the node supports GCC0 on the corresponding OTU2, OTU2e, and OTU4 interfaces. The node (Cisco FPGA) supports a maximum of 22 GCC channels for each card.



---

**Note** The GCC0 and GCC1 interfaces are supported on OTN-XP card and GCC2 interface is not supported.

---

From R7.3.1 onwards, the node supports GCC0 on the corresponding OTU2, OTU2e, OTU4, and Coherent DSP interfaces, and GCC1 on OTN ODU controller (ODU2, ODU2E, ODU4, and ODUcN).

From R7.3.2 onwards, the node (Cisco FPGA) supports a maximum of 48 GCC (GCC0 and GCC1) channels for each card.

- [Limitations, on page 212](#)
- [Supported Protocols, on page 213](#)
- [Enable the GCC Interface, on page 213](#)
- [Configure the GCC Interface, on page 214](#)
- [Configure Static Routes Over the GCC Interface, on page 216](#)
- [Configure OSPF Routes Over the GCC Interface, on page 216](#)
- [iBGP Support Using GCC, on page 217](#)

## Limitations

- gRPC is not supported over the GCC interface. Therefore, Open Config and streaming telemetry are not supported over the GCC interface.
- Only the Tx and Rx packet count information are available in GCC statistics.
- The devices can be remotely managed over the GCC interface only when they are connected to the management network through GCC. Therefore, initial provisioning and bringing up of the GCC interface must be performed either through the console or management Ethernet interface.
- The following headless or high availability events at the intermediate nodes may affect remote node management of subsequent nodes:
  - Reload of the route processor
  - Reload of IOS XR
  - Restart of the driver process
- IP fragmentation is not supported on GCC interface for the SCP protocol. As a workaround, you can apply any of the following configurations to limit the maximum packet size below the fragmentation limit (1454 bytes):
  - Use the **tcp mss** *<maximum segment size>* command (for example, **tcp mss 1200**) in the global configuration mode. The maximum segment limit is applied to all interfaces.
  - Use the **ipv4 mtu** *<MTU size>* command in the interface configuration mode. The MTU size is applied only to the specified interface.

# Supported Protocols

The following protocols are supported over the GCC interface.

- PING
- SSH
- TELNET
- SCP
- TFTP
- FTP
- SFTP
- HTTP
- HTTPS
- OSPF

## Enable the GCC Interface

### Enable the GCC Interface on 1.2T Card

To enable the GCC2 interface for the 1.2T line card, use the following commands:

```
configure
controller odu4 R/S/I/P/L
gcc2
commit
exit
```

To enable the GCC0 interface for the 1.2T line card, use the following commands:

```
configure
controller CoherentDSP R/S/I/P
gcc0
commit
exit
```

### Enable the GCC Interface on OTN-XP Card

To enable the GCC0 interface for the OTN-XP card, use the following commands:

```
RP/0/RP0/CPU0:ios#configure
RP/0/RP0/CPU0:ios(config)#controller {otu2 | otu2e | otu4} R/S/I/P/L
RP/0/RP0/CPU0:ios(config-otu)#gcc0
RP/0/RP0/CPU0:ios(config-otu)#commit
RP/0/RP0/CPU0:ios(config-otu)#exit
```

The following example displays how to enable the GCC0 interface for the OTN-XP card on OTU2 controller.

```
RP/0/RP0/CPU0:ios#configure
RP/0/RP0/CPU0:ios(config)#controller otu2 0/0/0/4/1
RP/0/RP0/CPU0:ios(config-otu2)#gcc0
RP/0/RP0/CPU0:ios(config-otu2)#commit
RP/0/RP0/CPU0:ios(config-otu2)#exit
```

To enable the GCC1 interface for the OTN-XP card, use the following commands:

```
RP/0/RP0/CPU0:ios#configure
RP/0/RP0/CPU0:ios(config)#controller {odu2 | odu2e | odu4 | oducn} R/S/I/P/L
RP/0/RP0/CPU0:ios(config-odu)#gcc1
RP/0/RP0/CPU0:ios(config-odu)#commit
RP/0/RP0/CPU0:ios(config-odu)#exit
```

The following example displays how to enable the GCC1 interface for the OTN-XP card on ODU2 controller.

```
RP/0/RP0/CPU0:ios#configure
RP/0/RP0/CPU0:ios(config)#controller odu2 0/0/0/4/1
RP/0/RP0/CPU0:ios(config-odu2)#gcc1
RP/0/RP0/CPU0:ios(config-odu2)#commit
RP/0/RP0/CPU0:ios(config-odu2)#exit
```

## Configure the GCC Interface

### Configure the GCC Interface on 1.2T Card

To configure the GCC2 interface using the static IP address for the 1.2T card, use the following commands:

```
configure
interface gcc2 R/S/I/P/L
ipv4 address ipv4-address
commit
exit
```

To configure the GCC0 interface using the static IP address for the 1.2T card, use the following commands:

```
configure
interface gcc0 R/S/I/P
ipv4 address ipv4-address
commit
exit
```

### Configure the GCC Interface on OTN-XP Card

To configure the GCC0 interface on OTN-XP card, use the following commands:

```
configure
```



```

interface gcc0 R/S/I/P
ipv4 address ipv4-address net-mask
commit
exit

```

To configure the GCC1 interface on OTN-XP card, use the following commands:

```

configure
interface gcc1 R/S/I/P
ipv4 address ipv4-address net-mask
commit
exit

```

### Examples

The following sample displays how to configure the GCC2 interface using the static IP address on 1.2T card:

```

RP/0/RP0/CPU0:ios#configure
RP/0/RP0/CPU0:ios(config)#interface gcc2 0/1/0/0/1
RP/0/RP0/CPU0:ios(config-if)#ipv4 address 198.51.100.244 255.255.255.0
RP/0/RP0/CPU0:ios(config-if)#commit
RP/0/RP0/CPU0:ios(config-if)#exit
RP/0/RP0/CPU0:ios(config)#exit
RP/0/RP0/CPU0:ios#show run interface gcc2 0/1/0/0/1
interface GCC20/1/0/0/1
  ipv4 address 10.1.1.1 255.255.255.0
!
```

The following sample displays how to configure the GCC2 interface using the loopback IP address on 1.2T card.

```

RP/0/RP0/CPU0:ios#configure
RP/0/RP0/CPU0:R2(config)#interface gcc2 0/1/0/0/1
RP/0/RP0/CPU0:R2(config-if)#ipv4 unnumbered loopback 0
RP/0/RP0/CPU0:ios(config-if)#exit
RP/0/RP0/CPU0:ios(config)#exit

```

The following sample checks the status of GCC2 interface.

```

RP/0/RP0/CPU0:ios#show ipv4 interface brief
Wed Sep 22 17:10:04.190 IST

```

Interface	IP-Address	Status	Protocol	Vrf-Name
GCC20/0/0/0/1	198.51.100.234	Up	Up	default
GCC20/3/0/1/3	198.51.100.244	Up	Up	default
Loopback0	198.51.100.224	Up	Up	default

The following sample displays how to configure the GCC0 interface using the static IP address on 1.2T or OTN-XP card.

```

RP/0/RP0/CPU0:ios#configure
RP/0/RP0/CPU0:ios(config)#interface gcc0 0/1/0/0
P/0/RP0/CPU0:ios(config-if)#ipv4 address 198.51.100.244 255.255.255.0
RP/0/RP0/CPU0:ios(config-if)#commit
RP/0/RP0/CPU0:ios(config-if)#exit
RP/0/RP0/CPU0:ios(config)#exit

```

```
RP/0/RP0/CPU0:ios#show run interface gcc0 0/1/0/0
interface GCC00/1/0/0
  ipv4 address 198.51.100.244 255.255.255.0
  !
```

The following sample displays how to configure the GCC0 interface using the loopback IP address on 1.2T or OTN-XP card.

```
RP/0/RP0/CPU0:ios#configure
RP/0/RP0/CPU0:R2(config)#interface gcc0 0/1/0/0
RP/0/RP0/CPU0:R2(config-if)#ipv4 unnumbered loopback 0
RP/0/RP0/CPU0:ios(config-if)#exit
RP/0/RP0/CPU0:ios(config)#exit
```

## Configure Static Routes Over the GCC Interface

To configure the static routes over the GCC interface, use the following commands:

**configure**

**router static address-family ipv4 unicast 0.0.0.0/0 default-gateway**

**exit**

### Examples

```
RP/0/RP0/CPU0:ios#configure
RP/0/RP0/CPU0:ios(config)#router static address-family ipv4 unicast 0.0.0.0/0 10.105.57.1
RP/0/RP0/CPU0:ios(config)#exit
```

## Configure OSPF Routes Over the GCC Interface

To configure OSPF routes over the GCC interface, use the following commands:

**configure**

**router ospf process-id**

**router-id ip-address**

**area area-id**

**interface type R/S/I/P/L**

**exit**

### Examples

The following is a sample to configure OSPF routes over the GCC interface.

**Gateway Node:**

```
configure
router ospf 1
router-id 192.0.2.89
```

```
area 0

interface Loopback0

!

interface MgmtEth0/RP0/CPU0/1

!

interface GCC20/0/0/0/1

!

interface GCC20/0/0/0/2
```

**Remote Node:**

```
configure
router ospf 1
router-id 192.0.2.92
redistribute connected

area 0

interface Loopback0

!

interface GCC20/0/0/0/1

!

interface GCC20/0/0/0/2
```

## iBGP Support Using GCC

The Internal BGP (iBGP) support over GCC allows external devices to exchange BGP routes through management interfaces of NCS1004 system. The NCS 1004 device advertises local networks through BGP and manages these networks using path learnt through BGP. With the iBGP route information, the NCS 1004 devices establish iBGP sessions over GCC to exchange BGP routes.

You can configure VPN routing and forwarding (VRF) on the GCC management interfaces (port 0 and port 1) of the NCS 1004 device. The VRF enables traffic isolation between the management ports (port 0 and port 1).

The GCC2 and GCC0 interfaces are supported in NCS 1004 for 1.2 T line card.

## Restrictions for iBGP Support Using GCC

- IP fragmentation is not supported on the GCC interface.
- The BGP configuration over Open Config (OC) is not supported.



**Note** The limitations of Remote Node Management Using GCC are applicable for iBGP Support Using GCC. For more information, see [Limitations](#).

## Enabling the GCC Interface

To enable the GCC2 interface, use the following commands:

```
configure
controller odu4 R/S/I/P/L
gcc2
commit
exit
```

To enable the GCC0 interface, use the following commands:

```
configure
controller CoherentDSP R/S/I/P
gcc0
commit
exit
```

## Configuring the Management Interface

To configure the management Ethernet interface with VRF, use the following commands:

```
RP/0/RP0/CPU0:ios#configure
RP/0/RP0/CPU0:ios#interface MgmtEth0/RP0/CPU0/1
RP/0/RP0/CPU0:ios(config-if)#vrf transport-vrf
RP/0/RP0/CPU0:ios(config-if)#ipv4 address ipv4-address
RP/0/RP0/CPU0:ios(config-if)#commit
RP/0/RP0/CPU0:ios(config-if)#exit
```

The following example displays how to configure the management Ethernet interface with VRF.

```
RP/0/RP0/CPU0:ios#configure
RP/0/RP0/CPU0:ios#interface MgmtEth0/RP0/CPU0/1
RP/0/RP0/CPU0:ios(config-if)#vrf transport-vrf
RP/0/RP0/CPU0:ios(config-if)#ipv4 address 192.0.2.1 255.255.255.255
RP/0/RP0/CPU0:ios(config-if)#commit
RP/0/RP0/CPU0:ios(config-if)#exit
```

## Configuring the Loopback Interface

To configure the loopback interface 0 with VRF, use the following commands:

```
RP/0/RP0/CPU0:ios#configure
RP/0/RP0/CPU0:ios#interface Loopback0
RP/0/RP0/CPU0:ios(config-if)#vrf transport-vrf
RP/0/RP0/CPU0:ios(config-if)#ipv4 address ipv4-address
RP/0/RP0/CPU0:ios(config-if)#commit
RP/0/RP0/CPU0:ios(config-if)#exit
```

The following example displays how to configure the loopback interface 0 with VRF.

```
RP/0/RP0/CPU0:ios#configure
RP/0/RP0/CPU0:ios#interface Loopback0
RP/0/RP0/CPU0:ios(config-if)#vrf transport-vrf
RP/0/RP0/CPU0:ios(config-if)#ipv4 address 192.0.2.1 255.255.255.255
RP/0/RP0/CPU0:ios(config-if)#commit
RP/0/RP0/CPU0:ios(config-if)#exit
```

## Configuring the GCC interface

To configure the GCC2 interface with VRF and static IP address, use the following commands:

```
configure
interface gcc2 R/S/I/P/L
vrf transport-vrf
ipv4 address ipv4-address
commit
exit
```

To configure the GCC0 interface with VRF and static IP address, use the following commands:

```
configure
interface gcc0 R/S/I/P
vrf transport-vrf
ipv4 address ipv4-address
commit
exit
```

### Examples

The following sample displays how to configure the GCC2 interface with VRF and static IP address.

```
RP/0/RP0/CPU0:ios#configure
RP/0/RP0/CPU0:ios(config)#interface gcc2 0/1/0/0/1
RP/0/RP0/CPU0:ios(config-if)#vrf transport-vrf
P/0/RP0/CPU0:ios(config-if)#ipv4 address 198.51.100.5 255.255.255.0
RP/0/RP0/CPU0:ios(config-if)#commit
RP/0/RP0/CPU0:ios(config-if)#exit
RP/0/RP0/CPU0:ios(config)#exit
```

The following sample displays how to configure the GCC2 interface using loopback IP address.

```
RP/0/RP0/CPU0:ios#configure
RP/0/RP0/CPU0:R2(config)#interface gcc2 0/1/0/0/1
RP/0/RP0/CPU0:R2(config-if)#ipv4 unnumbered loopback 0
RP/0/RP0/CPU0:ios(config-if)#exit
RP/0/RP0/CPU0:ios(config)#exit
```

The following sample displays how to configure the GCC0 interface with VRF and static IP address.

```
RP/0/RP0/CPU0:ios#configure
RP/0/RP0/CPU0:ios(config)#interface gcc0 0/1/0/0
RP/0/RP0/CPU0:ios(config-if)#vrf transport-vrf
P/0/RP0/CPU0:ios(config-if)#ipv4 address 198.51.100.2 255.255.255.0
RP/0/RP0/CPU0:ios(config-if)#commit
RP/0/RP0/CPU0:ios(config-if)#exit
RP/0/RP0/CPU0:ios(config)#exit
```

The following sample displays how to configure the GCC0 interface using the loopback IP address.

```
RP/0/RP0/CPU0:ios#configure
RP/0/RP0/CPU0:R2(config)#interface gcc0 0/1/0/0
RP/0/RP0/CPU0:R2(config-if)#ipv4 unnumbered loopback 0
RP/0/RP0/CPU0:ios(config-if)#exit
RP/0/RP0/CPU0:ios(config)#exit
```

## Verifying iBGP Support Using GCC

To verify BGP support using GCC configuration, use the following **show** commands:

```
RP/0/RP0/CPU0:ios#show bgp vrf transport-vrf neighbors brief
Neighbor      Spk    AS Description                               Up/Down  NBRState
198.51.100.0   0      200                                           00:51:49 Established
198.51.100.1   0      100                                           00:50:32 Established
```

```
RP/0/RP0/CPU0:ios#show bgp vrf transport-vrf
BGP VRF transport-vrf, state: Active
BGP Route Distinguisher: 192.0.2.7:0
VRF ID: 0x60000002
BGP router identifier 192.0.2.7, local AS number 100
Non-stop routing is enabled
BGP table state: Active
Table ID: 0xe0000002  RD version: 51
BGP main routing table version 51
BGP NSR Initial initsync version 11 (Reached)
BGP NSR/ISSU Sync-Group versions 0/0
```

```
Status codes: s suppressed, d damped, h history, * valid, > best
                i - internal, r RIB-failure, S stale, N Nexthop-discard
Origin codes: i - IGP, e - EGP, ? - incomplete
```

```
Network          Next Hop          Metric LocPrf Weight Path
Route Distinguisher: 192.0.2.7:0 (default for vrf transport-vrf)

*> 209.165.201.30/27      198.51.100.0          0          0 200 i
*> 209.165.201.28/27      0.0.0.0              0          32768 i
*> 209.165.201.26/27      0 100                0 i
*> 209.165.201.24/27      198.51.100.2          0          100      0 300 i
```

```
RP/0/RP0/CPU0:ios#show bgp vrf transport-vrf
BGP VRF transport-vrf, state: Active
BGP Route Distinguisher: 203.0.113.10:0
VRF ID: 0x60000002
BGP router identifier 203.0.113.10, local AS number 100
Non-stop routing is enabled
BGP table state: Active
Table ID: 0xe0000002  RD version: 51
BGP main routing table version 51
BGP NSR Initial initsync version 11 (Reached)
```

```

BGP NSR/ISSU Sync-Group versions 0/0

Status codes: s suppressed, d damped, h history, * valid, > best
               i - internal, r RIB-failure, S stale, N Nexthop-discard
Origin codes: i - IGP, e - EGP, ? - incomplete
   Network      Next Hop          Metric LocPrf Weight Path
Route Distinguisher: 203.0.113.10:0 (default for vrf transport-vrf)

*> 209.165.201.30/27      198.51.100.0          0           0 200 i
*> 209.165.201.28/27      0.0.0.0                0           32768 i
*>i209.165.201.26/27      198.51.100.12         0    100     0 i
*>i209.165.201.24/27      198.51.100.24         0    100     0 300 i
    
```

## Use Case - iBGP Support Using GCC Configuration

Consider two NCS 1004 devices R2 and R3 connected through GCC0 interfaces.

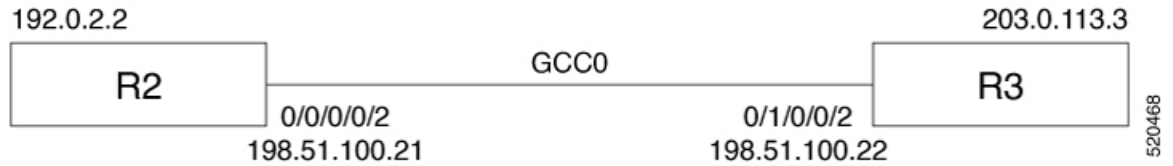

R2 is connected through GCC0 0/0/0/0 interface with IP address of 198.51.100.21 and R3 is connected through GCC0 0/1/0/0 with IP address of 198.51.100.22. The R2 and R3 devices are connected to external devices through management interfaces.

**Table 28:**

Configuration on R2	Configuration on R3
<p><b>Global Configuration on R2</b></p> <pre> hw-module location 0/0 mxponder   trunk-rate 600G   client-rate 100GE  vrf transport-vrf   address-family ipv4 unicast                     </pre>	<p><b>Global Configuration on R3</b></p> <pre> hw-module location 0/0 mxponder   trunk-rate 600G   client-rate 100GE  vrf transport-vrf   address-family ipv4 unicast                     </pre>

Configuration on R2	Configuration on R3
<p><b>Interface Configuration on R2</b></p> <pre>interface Loopback0  vrf transport-vrf  ipv4 address 192.0.2.2 255.255.255.255  interface MgmtEth0/RP0/CPU0/1  vrf transport-vrf  ipv4 address 198.51.100.25 255.255.255.0  controller ODU40/0/0/0/2  gcc2  interface GCC20/0/0/0/2  vrf transport-vrf  ipv4 address 198.51.100.21 255.255.255.0</pre>	<p><b>Interface Configuration on R3</b></p> <pre>interface Loopback0  vrf transport-vrf  ipv4 address 203.0.113.3 255.255.255.255  interface MgmtEth0/RP0/CPU0/1  vrf transport-vrf  ipv4 address 198.51.100.32 255.255.255.0  controller ODU40/1/0/0/2  gcc2  interface GCC20/1/0/0/2  vrf transport-vrf  ipv4 address 198.51.100.22 255.255.255.0</pre>
<p><b>Route-policy Configuration on R2</b></p> <pre>route-policy PASS-ALL  pass  end-policy</pre>	<p><b>Router Policy Configuration on R3</b></p> <pre>route-policy PASS-ALL  pass  end-policy</pre>
<p><b>Static Route Configuration on R2</b></p> <pre>router static  address-family ipv4 unicast  0.0.0.0/0 198.51.100.28  !  vrf transport-vrf  address-family ipv4 unicast  198.51.100.0/24 198.51.100.22</pre>	<p><b>Static Route Configuration on R3</b></p> <pre>router static  address-family ipv4 unicast  0.0.0.0/0 198.51.100.28  !  vrf transport-vrf  address-family ipv4 unicast  198.51.100.0/24 198.51.100.21</pre>
<p><b>BGP Configuration on R2</b></p> <pre>router bgp 100  bgp router-id 192.0.2.123  address-family vpnv4 unicast  !  vrf transport-vrf  rd auto  address-family ipv4 unicast  network 203.0.113.1/32  !  neighbor 198.51.100.22  remote-as 100  address-family ipv4 unicast  route-policy PASS-ALL in  route-policy PASS-ALL out  next-hop-self  !</pre>	<p><b>BGP Configuration on R3</b></p> <pre>router bgp 100  bgp router-id 192.0.2.124  address-family vpnv4 unicast  !  vrf transport-vrf  rd auto  address-family ipv4 unicast  network 203.0.113.3/32  !  neighbor 198.51.100.21  remote-as 100  address-family ipv4 unicast  route-policy PASS-ALL in  route-policy PASS-ALL out  next-hop-self  !</pre>



Configuration on R2	Configuration on R3
<p><b>BGP Verification on R2</b></p> <pre>RP/0/RP0/CPU0:ios#show bgp sessions Mon Jul 20 14:47:30.378 UTC</pre> <pre>Neighbor          VRF                Spk AS   InQ  OutQ  NBRState  NSRState 198.51.100.22  transport-vrf      0 100           0      0  Established  None</pre>	<p><b>BGP Verification on R3</b></p> <pre>RP/0/RP0/CPU0:regen#show bgp sessions Tue Jul 21 02:50:14.134 UTC</pre> <pre>Neighbor          VRF                Spk AS   InQ  OutQ  NBRState  NSRState 198.51.100.21  transport-vrf      0 100           0      0  Established  None</pre>





## CHAPTER 9

# Smart Licensing

This chapter describes the smart licensing configuration on Cisco NCS 1004.

- [Understanding Smart Licensing, on page 225](#)
- [Creating a Token, on page 229](#)
- [Configure Smart Licensing, on page 229](#)
- [Smart Licensing for OTN-XP Line Card, on page 237](#)

## Understanding Smart Licensing

Smart Licensing is a cloud-based approach to licensing. Smart Licensing simplifies the licensing experience across the enterprise making it easier to purchase, deploy, track, and renew Cisco Software. It provides visibility into license ownership and consumption through a single, simple user interface. The solution allows you to easily track the status of your license and software usage trends.

Smart Licensing helps you simplify three core functions:

- **Purchasing:** The software that you have installed in your network can be registered, without Product Activation Keys (PAKs).
- **Management:** You can automatically track activations against your license entitlements. Also, there is no need to install the license file on every node. You can create license pools (logical grouping of licenses) to reflect your organization structure. Smart Licensing offers you Cisco Smart Software Manager, a centralized portal that enables you to manage all your Cisco software licenses from one centralized website.
- **Reporting:** Through the portal, Smart Licensing offers an integrated view of the licenses you have purchased and what has been deployed in your network. You can use this data to make better purchasing decisions, based on your consumption.

### Smart Licensing Features

- Your device initiates a call home and requests the licenses it needs.
- Pooled licences - Licences are company account-specific, and can be used with any compatible device in your company. You can activate or deactivate different types of licenses on the device without actually installing a license file on the device.
- Licenses are stored securely on Cisco servers.

- Licenses can be moved between product instances without license transfer. This greatly simplifies the reassignment of a software license as part of the Return Material Authorization (RMA) process.
- It provides a complete view of all the Smart Software Licenses used in the network using a consolidated usage report of software licenses and devices in one easy-to-use portal.

### Cisco Smart Account

Cisco Smart Account is an account where all products enabled for Smart Licensing are deposited. Cisco Smart Account allows you to manage and activate your licenses to devices, monitor license use, and track Cisco license purchases. Through transparent access, you have a real-time view into your Smart Licensing products. IT administrators can manage licenses and account users within your organization's Smart Account through the Smart Software Manager.

When creating a Smart Account, you must have the authority to represent the requesting organization. After you submit the request, it goes through a brief approval process. Access <http://software.cisco.com> to learn about, set up, or manage Smart Accounts.

### Cisco Smart Software Manager Overview

Cisco Smart Software Manager enables you to manage all your Cisco Smart software licenses from one centralized website. With Cisco Smart Software Manager, you organize and view your licenses in groups called virtual accounts (collections of licenses and product instances). Use the Cisco Smart Software Manager to do the following tasks:

- Create, manage, or view virtual accounts.
- Create and manage Product Instance Registration Tokens.
- Transfer licenses between virtual accounts or view licenses.
- Transfer, remove, or view product instances.
- Run reports against your virtual accounts.
- Modify your email notification settings.
- View overall account information.

### Virtual Accounts

A Virtual Account exists as a sub-account tithing the Smart Account. Virtual Accounts are a customer-defined structure based on organizational layout, business function, geography, or any defined hierarchy. They are created and maintained by the Smart Account administrator. Smart Licensing allows you to create multiple license pools or virtual accounts within the Smart Software Manager portal. Using the Virtual Accounts option that you can aggregate licenses into discrete bundles that are associated with a cost center so that one section of an organization cannot use the licenses of another section of the organization. For example, if you segregate your company into different geographic regions, you can create a virtual account for each region to hold the licenses and product instances for that region.

All new licenses and product instances are placed in the default virtual account in the Smart Software Manager, unless you specify a different one during the order process. After you access the default account, you may choose to transfer them to any other account, provided you have the required access permissions.

Use the Smart Software Manager portal to create license pools or transfer licenses.

### Product Instance Registration Tokens

A product requires a registration token until you have registered the product. On successful registration, the device receives an identity certificate. This certificate is saved and automatically used for all future communications with Cisco. Registration tokens are stored in the Product Instance Registration Token Table that is associated with your enterprise account. Registration tokens can be valid 1–365 days.

### Product Instances

A product instance is an individual device with a unique device identifier (UDI) that is registered using a product instance registration token (or registration token). You can register any number of instances of a product with a single registration token. Each product instance can have one or more licenses residing in the same virtual account. Product instances must periodically connect to the Cisco Smart Software Manager servers during a specific renewal period. If you remove the product instance, its licenses are released and made available within the virtual account.

### Smart Licensing Work Flow

The following figure depicts a working model of smart licensing that involves a three-step procedure.

**Figure 7: Smart Licensing Work Flow**



1. **Setting up Smart Licensing:** You can place the order for Smart Licensing, to manage licenses on the Cisco.com portal. You agree to the terms and conditions governing the use and access of Smart Licensing in the Smart Software Manager portal.
2. **Enabling and Use Smart Licensing:** Smart Licensing is enabled by default. You can use either of the following options to communicate:
  - **Smart Call Home:** The Smart Call Home feature is automatically configured when Smart Licensing is enabled. Smart Call Home is used by Smart Licensing as a medium for communication with the Cisco license service. Call Home feature allows Cisco products to periodically call-home and perform an audit and reconciliation of your software usage information. This information helps Cisco efficiently track your install base, keep them up and running, and effectively pursue service and support contract renewals. For more information on Smart Call Home feature, see [http://www.cisco.com/c/dam/en/us/td/docs/switches/lan/smart\\_call\\_home/SCH\\_Deployment\\_Guide.pdf](http://www.cisco.com/c/dam/en/us/td/docs/switches/lan/smart_call_home/SCH_Deployment_Guide.pdf).
  - **Smart Software Manager Satellite :** is a component of Cisco Smart Licensing and works with Cisco Smart Software Manager (SSM). It helps customers intelligently manage product licenses, providing near real-time visibility and reporting of the Cisco licenses they purchase and consume.

For customers who do not want to manage their installed base using a direct Internet connection, the Smart Software Manager satellite is installed on the customer premises and provides a subset of Cisco SSM functionality. After you download the satellite application, deploy it, and register it to Cisco SSM, you can perform the following functions locally:

- Activate or register a license
- Get visibility to your company's licenses
- Transfer licenses between company entities

Periodically, the satellite must synchronize with Cisco SSM to reflect the latest license entitlements.

For more information about the Smart Software Manager satellite, see <http://www.cisco.com/c/en/us/buy/smart-accounts/software-manager-satellite.html>.

3. **Manage and Report Licenses:** You can manage and view reports about your overall software usage in the Smart Software Manager portal. Compliance reporting describes the types of Smart Licensing reports.

## Benefits of Smart Licensing

- Licenses are not locked to perform configurations even if the license limit exceeds the paid license limit. You are notified with out-of-compliance notification to buy additional licenses when the license limit exceeds the paid license limit. This saves time with the ability to transfer licenses across the organization.
- Licenses can be pooled across the entire organization, enabling them to be reused across organizational boundaries.
- Provides software asset management information so that you can plan and track the licenses.

## Licensing in NCS 1004

Cisco NCS 1004 has the following line card PIDs :

- **NCS1K4-1.2T-K9**—High-cost PID. This card does not support smart licensing.
- **NCS1K4-1.2T-L-K9**—Licensed PID for 1.2T line card and the licenses are charged per port.
- **NCS1K4-OTN-XPL**—Licensed PID for OTN-XP line card.
- **NCS1K4-QXP-L-K9**—Licensed PID for QXP line card.
- **NCS1K4-QXP-K9** —Non-licensed PID for QXP line card.

You can use either one or a combination of both types of the 1.2T line card in the NCS 1004.

## Software Entitlements of Cisco NCS 1004

Software entitlement is a system that consists of a license manager on Cisco NCS 1004. The license manager manages licenses for various software and hardware features. The license manager parses and authenticates the license before accepting it.

The following table lists the features and its corresponding entitlements that can be enabled on Cisco NCS 1004 using licenses:

**Table 29: Software Entitlements of Cisco NCS 1004**

Feature	Software Entitlement
NCS1K4 Smart License-one QSFP28 client	S-NCS1K4-LIC-100G=
NCS1K4 Smart License - one QSFP28 client with encryption	S-NCS1K4-LIC-100X=
NCS1K4 Smart License - 100Gbps of client bandwidth	S-NCS1K4-100G-CL=
NCS1K4 Smart License - Long Haul	S_NCS1K4_LONGHAUL
NCS1K4 Smart License - Subsea	S_NCS1K4_SUBSEA

The licenses are charged per port basis and dependent on the number of trunk ports and client ports that you configure. The license count for the configuration of 4 x 100GE client ports or lesser is zero. For configurations greater than 4 x 100GE client ports, the license count is incremented by one for every 100GE client port configured at the slice level. The license count for the trunk port is incremented based on the BPS & optics configuration.

## Creating a Token

To create a new token using Cisco Smart Software Manager, perform the following tasks:

### Procedure

- 
- Step 1** Log in to the Cisco Smart Software Manager.  
<https://software.cisco.com/software/cswws/platform/home#SmartLicensing-Inventory>
  - Step 2** Select the token with the name that was provided while creating the token.
  - Step 3** Click on the blue arrow on the token. The token ID generates.
  - Step 4** Copy the token and register the NCS1004 with the same token ID.
- 

## Configure Smart Licensing

To configure smart licensing in Cisco NCS 1004, perform the following tasks:

### Procedure

- 
- Step 1** Configure the domain name server for the smart license server.

**Example:**

```
RP/0/RP0/CPU0:ios#configure
Sat Dec 15 15:25:14.385 IST
RP/0/RP0/CPU0:NCS1004(config)#domain name-server 198.51.100.247
```

**Step 2** Setup the CiscoTAC-1 profile and destination address for Smart Call Home, using the following commands:

**call-home**

**service active**

**contact smart-licensing**

**profile CiscoTAC-1**

**active**

**destination address http {http|https}://{FQDN}/its/service/oddce/services/DDCEService**

**destination transport-method http**

**Note** FQDN must be either Cisco Smart Software Manager FQDN (tools.cisco.com) or Smart Licensing satellite server FQDN. You must configure the DNS server before setting-up the call-home destination address as FQDN. Use the **domain name-server {DNS server IP}** command to configure the DNS server on the device.

**Example:**

```
domain name-server 198.51.100.247
call-home
service active
contact smart-licensing
profile CiscoTAC-1
active
destination address http https://tools.cisco.com/its/service/oddce/services/DDCEService
destination transport-method http
```

**Note** **CiscoTAC-1** profile is the default profile for smart licensing and it must not be deleted.

**Step 3** Configure the crypto ca Trust point profile, if CRL distribution point is not defined in the Satellite server certificate or if the device is not able to reach the host mentioned in the CRL distribution point.

**Example:**

```
RP/0/RP0/CPU0:ios(config)#crypto ca trustpoint Trustpool crl optional
```

**Step 4** Create and copy the registration token ID using Cisco Smart Software Manager.

For more details about creating a token, see [Creating a Token, on page 229](#).

**Step 5** In the privileged EXEC mode, register the token ID in Cisco NCS 1004, using the following commands:

**license smart register idtoken *token-ID***

The registration may fail if the token is invalid or there is communication failure between the device and the portal or satellite. If there is a communication failure, there is a wait time of 24 hours before the device attempts to register again. To force the registration, use the **license smart register idtoken *token-ID* force** command.

When your device is taken off the inventory, shipped elsewhere for redeployment, or returned to Cisco for replacement using the return merchandise authorization (RMA) process, you can use the **license smart deregister** command to cancel the registration on your device. All smart licensing entitlements and certificates on the platform are removed.



ID certificates are renewed automatically after six months. In case, the renewal fails, the product instance goes into unidentified state. You can manually renew the ID certificate using the **license smart renew id** command.

Authorization periods are renewed by the Smart Licensing system every 30 days. As long as the license is in an 'Authorized' or 'Out-of-Compliance' (OOC), the authorization period is renewed. Use the **license smart renew auth** command to make an on-demand manual update of your registration. Thus, instead of waiting 30 days for the next registration renewal cycle, you can issue this command to instantly find out the status of your license.

After 90 days, the authorization period expires and the status of the associated licenses display "AUTH EXPIRED". Use the **license smart renew auth** command to retry the authorization period renewal. If the retry is successful, a new authorization period begins.

## Verifying Smart Licensing Configuration

After enabling Smart Licensing, you can use the **show** commands to verify the default Smart Licensing configuration. If any issue is detected, take corrective action before making further configurations.

- **show license all**
- **show license trace all**
- **show license status**
- **show license summary**
- **show license tech**
- **Show license udi**
- **show license usage**
- **show license platform detail**
- **show license platform summary**
- **show license platform trace**
- **Show license platform trace all**
- **show tech-support smartlic**
- **show call-home detail**
- **show call-home trace all**
- **show tech-support call-home**

The following table defines the available license authorization status in Cisco NCS 1004:

**Table 30: License Authorization Status**

License Authorization Status	Description
Unconfigured	Smart Software Licensing is not configured.

License Authorization Status	Description
Unidentified	Smart Software Licensing is enabled but is not registered.
Registered	Device registration is completed and an ID certificate is received that is used for future communication with the Cisco licensing authority.
Authorized	Registration is completed with a valid Smart Account and license consumption has begun. This indicates compliance.
Out of Compliance	Consumption exceeds available licenses in the Smart Account.
Authorization Expired	The device is unable to communicate with the Cisco Smart Software Manager for an extended period. This state occurs after 90 days of expiry. The device attempts to contact the CSSM every hour to renew the authorization until the registration period expires.

**Example 1:**

The following example shows the sample output of the **show license all** command.

```
RP/0/RP0/CPU0:SIT-5#show license all
Wed Sep 22 17:18:19.761 IST

Smart Licensing Status
=====

Smart Licensing is ENABLED

Registration:
  Status: REGISTERED
  Smart Account: BU Production Test
  Virtual Account: NCS1000
  Export-Controlled Functionality: ALLOWED
  Initial Registration: SUCCEEDED on Jun 21 2021 12:40:52 IST
  Last Renewal Attempt: None
  Next Renewal Attempt: Dec 18 2021 12:40:51 IST
  Registration Expires: Jun 21 2022 12:35:49 IST

License Authorization:
  Status: AUTHORIZED on Sep 09 2021 11:45:43 IST
  Last Communication Attempt: SUCCEEDED on Sep 09 2021 11:45:43 IST
  Next Communication Attempt: Oct 09 2021 11:45:42 IST
  Communication Deadline: Dec 08 2021 11:40:41 IST

Export Authorization Key:
  Features Authorized:
    <none>

Utility:
  Status: DISABLED

Data Privacy:
  Sending Hostname: yes
  Callhome hostname privacy: DISABLED
  Smart Licensing hostname privacy: DISABLED
  Version privacy: DISABLED

Transport:
  Type: Callhome
```

```

Miscellaneous:
  Custom Id: <empty>

License Usage
=====

NCS1K4 - Subsea - 1.2T Line Card (S_NCS1K4_SUBSEA):
  Description: NCS1K4 - Subsea - 1.2T Line Card
  Count: 3
  Version: 1.0
  Status: AUTHORIZED
  Export status: NOT RESTRICTED

NCS1K4 smart license - one QSFP28 client (S-NCS1K4-LIC-100G=):
  Description: NCS1K4 smart license - one QSFP28 client
  Count: 18
  Version: 1.0
  Status: AUTHORIZED
  Export status: NOT RESTRICTED

NCS1K4 smart license - one QSFP28 client with encryption (S-NCS1K4-LIC-100X=):
  Description: NCS1K4 smart license - one QSFP28 client with encryption
  Count: 2
  Version: 1.0
  Status: AUTHORIZED
  Export status: NOT RESTRICTED

NCS1K4 - Long Haul - 1.2T Line Card (S_NCS1K4_LONGHAUL):
  Description: NCS1K4 - Long Haul - 1.2T Line Card
  Count: 2
  Version: 1.0
  Status: AUTHORIZED
  Export status: NOT RESTRICTED

Product Information
=====
UDI: SN:CAT2249B009,UUID:default-sdr

Agent Version
=====
Smart Agent for Licensing: 4.13.32_rel/85

Reservation Info
=====
License reservation: DISABLED

```

**Example 2:**

The following example shows the sample output of the **show license platform detail** command.

```

RP/0/RP0/CPU0:ios#show license platform detail
Mon Feb 11 15:59:55.422 IST
Current state:    REGISTERED

Collection: LAST: Mon Feb 11 2019 15:57:53 IST
              NEXT: Mon Feb 11 2019 16:57:53 IST
Reporting:  LAST: Mon Feb 11 2019 15:57:53 IST
              NEXT: Tue Feb 12 2019 15:57:53 IST

Parameters: Collection interval:      60 minute(s)
              Reporting interval:    1440 minute(s)
              Throughput gauge:      1000000 Kbps

```

```

=====
Feature/Area 'system'
  Name: System
  Status: ACTIVE
  Flags: CONFIG

  [ 1] Name: NCS1K4 smart license - one QSFP28 client
        Entitlement Tag:
regid.2018-05.com.cisco.S-NCS1K4-LIC-100G=,1.0_03df009f-5ac5-48da-af50-4279ddea5e24
        Count: Last reported: 8
                Next report: 0
  [ 2] Name: NCS1K4 smart license - one QSFP28 client with encryption
        Entitlement Tag:
regid.2018-05.com.cisco.S-NCS1K4-LIC-100X=,1.0_3938b0c5-f635-4426-9f0f-936d930cea9e
        Count: Last reported: 8
                Next report: 0

```

**Example 3:**

The following example shows the sample output of the **show license status** command.

```

RP/0/RP0/CPU0:ios#show license status
Mon Feb 11 16:02:24.499 IST

Smart Licensing is ENABLED
  Initial Registration: SUCCEEDED on Mon Feb 11 2019 15:51:10 IST
  Last Renewal Attempt: None
  Next Renewal Attempt: Sat Aug 10 2019 15:52:10 IST
  Registration Expires: Tue Feb 11 2020 15:46:59 IST

License Authorization:
  Status: AUTHORIZED on Mon Feb 11 2019 15:53:40 IST
  Last Communication Attempt: SUCCEEDED on Mon Feb 11 2019 15:53:40 IST
  Next Communication Attempt: Wed Mar 13 2019 15:53:39 IST
  Communication Deadline: Sun May 12 2019 15:47:29 IST

```

**Example 4:**

The following example shows the sample output of the **show license usage** command.

```

RP/0/RP0/CPU0:ios#show license usage
Mon Feb 11 15:59:29.817 IST

License Authorization:
  Status: AUTHORIZED on Mon Feb 11 2019 15:53:40 IST

NCS1K4 smart license - one QSFP28 client (S-NCS1K4-LIC-100G=):
  Description: NCS1K4 smart license - one QSFP28 client
  Count: 8
  Version: 1.0
  Status: AUTHORIZED

NCS1K4 smart license - one QSFP28 client with encryption (S-NCS1K4-LIC-100X=):
  Description: NCS1K4 smart license - one QSFP28 client with encryption
  Count: 8
  Version: 1.0
  Status: AUTHORIZED

```

**Example 5:**

The following example shows the sample output of the **show license udi** command.

```
RP/0/RP0/CPU0:ios#show license udiMon Feb 11 16:02:46.733 IST

Product Information
=====
UDI: SN:CAT2231B18Y,UUID:default-sdr
```

## Criteria for the License Consumption of Subsea Networks

**Table 31: Feature History**

Feature Name	Release Information	Feature Description
Licensing Feature Update	Cisco IOS XR Release 7.3.2	Criteria for license consumption in Long Haul and Subsea networks are introduced. Long Haul (LH) and Subsea are two trunk-based license models that are implemented regardless of the line rate, in addition to the existing client-based licenses. These license models allow the user to easily track the status of licenses and software usage trends. The long-haul license is required to enable QPSK and 8QAM modes. The subsea license is required to enable BPSK and subsea specific controls such as extended chromatic dispersion, special non-linear compensation settings and so on.

The criteria for license consumption of subsea networks are as follows:

- If you configure any of the following configurations on the trunk port and the configurations are present in the output of **show running-configuration** command, then the license is consumed.
  - `Ios(config-optics)#filter-roll-off-factor <0-1>`
  - `Ios(config-optics)#rx-voa target-power <-190,+30>`
  - `Ios(config-optics)#rx-voa fixed-ratio <+100,+1700>`
  - `Ios(config-optics)#enh-colorless-mode <1-3>`
  - `Ios(config-optics)#enh-sop-tol-mode <1-3>`
  - `Ios(config-optics)#nleq-comp-mode <1-4>`
  - `Ios(config-optics)#cross-pol-gain-mode <1-15>`
  - `Ios(config-optics)#cross-pol-weight-mode <1-7>`
  - `Ios(config-optics)#cpr-win-mode <1-15>`

- `Ios(config-optics)#cpr-ext-win-mode <1-15>`

- The license is consumed if the bps value is in the range of 1–2 bits per symbol or 1, excluding the boundary value of 2 in the following command:

```
show controller optics <trunk-port>
```

- The license is consumed if the cd-min value is less than -10000 or cd-max value is greater than 100000, excluding the boundary values in the output of the following command:

```
show controller optics <trunk-port>
```

### Example for License Consumption:

The following output of **show license usage** command shows the license usage count as one.

```
RP/0/RP0/CPU0:BH-SIT2#show license usage
Tue Aug 3 11:12:42.440 IST
License Authorization:
Status: AUTHORIZED on Aug 03 2021 11:10:12 IST
NCS1K4 - Subsea - 1.2T Line Card (S_NCS1K4_SUBSEA):
Description: NCS1K4 - Subsea - 1.2T Line Card
Count: 1
Version: 1.0
Status: AUTHORIZED
Export status: NOT RESTRICTED
```

## Criteria for the License Consumption of Long Haul Networks

The smart license is consumed if the bps value is in the range of 2–4 bits per symbol including the boundary values in the output of the following command:

```
show controller optics 0/1/0/1
```

### Example:

```
show controller optics 0/1/0/1
      Bits per symbol = 3.0000000000 bits/symbol
```

In the above example, the bits per symbol value is 3, so the license is consumed.



### Note

- The license is consumed even when the trunk port is in shutdown state.
- The license is consumed only when the line card is up and running.

### Example for License Consumption:

The following output of **show license usage** command shows the license usage count as two:

```
RP/0/RP0/CPU0:SIT-4#show license usage
Tue Aug 3 15:53:48.453 IST
License Authorization:
NCS1K4 - Long Haul - 1.2T Line Card (S_NCS1K4_LONGHAUL):
Description: NCS1K4 - Long Haul - 1.2T Line Card
Count: 2
Version: 1.0
Status: AUTHORIZED
Export status: NOT RESTRICTED
```

## License Registration

You can use the following procedure to register license:

### Procedure

- 
- Step 1** Register the license using the following command:
- ```
RP/0/RP0/CPU0:ios#license smart register idtoken <idtoken>
```
- Step 2** Browse to the URL : <https://software.cisco.com/software/cs/ws/platform/home#module/SmartLicensing>.
- Step 3** Click **Inventory**.
- Step 4** Click **Product Instances**.
- Step 5** Select the node instance.
- Step 6** Click **Actions**.
- Step 7** Click **Remove**.
- Step 8** Renew the authorization period using the following command:
- ```
RP/0/RP0/CPU0:ios#license smart renew auth

RP/0/RP0/CPU0:ios#show logging | i "Data and signature"
Thu May 27 09:57:02.237 UTC
RP/0/RP0/CPU0:May 27 09:54:57.783 UTC: smartlicserver[311]:
LICENSE-SMART_LIC-3-AUTH_RENEW_FAILED : Authorization renewal with the Cisco Smart Software
  Manager (CSSM) :
Error received from Smart Software Manager: Data and signature do not match for udi
PID:8812,SN:FOX2202WIVM
```
- Note** The error message in the output of the **show logging** command is expected and is due to loss of synchronization between the CSSM server and the device after removing the product instance directly from the CSSM server.
- Step 9** Perform deregister using the following command:
- ```
RP/0/RP0/CPU0:ios#license smart deregister

RP/0/RP0/CPU0:ios#show logging | i DEREG
Thu May 27 14:48:58.170 UTC
RP/0/RP0/CPU0:May 27 09:58:58.464 UTC: smartlicserver[311]:
%LICENSE-SMART_LIC-3-AGENT_DEREG_FAILED : Smart Agent for Licensing DeRegistration with
Cisco Smart Software Manager (CSSM) failed:
Agent received a failure status in a response message. Please check the Agent log file for
the detailed message.
```
- Note** The error message in the output of the **show logging** command is expected.
- 

## Smart Licensing for OTN-XP Line Card

### Overview

- The license calculation is based on 100G client bandwidth and is independent of the client type.

- The licensed OTN-XP Line Card PID is NCS1K4-OTN-XPL.
- The license is charged based on the usage of 100G client bandwidth.

## Checking the License Usage Count

You can also check the number of licenses utilised, by entering the **show license all** command.

### Configuring Slice

The following sample shows the configuration of slice 0 in Muxponder mode.

```
RP/0/RP0/CPU0:ios(config)#hw-module location 0/1 mxponder-slice 0
 trunk-rate 100G
 client-port-rate 2 lane 3 client-type OTU2
 client-port-rate 2 lane 4 client-type OTU2E
 client-port-rate 4 lane 1 client-type 10GE
 client-port-rate 4 lane 2 client-type OTU2
 client-port-rate 4 lane 3 client-type OTU2E
 client-port-rate 4 lane 4 client-type 10GE
 client-port-rate 5 lane 1 client-type OTU2E
 client-port-rate 5 lane 2 client-type 10GE
 client-port-rate 5 lane 3 client-type OTU2
 client-port-rate 5 lane 4 client-type OTU2E
```

### Checking the Slice State

The following sample shows the status of the configured slice as **Provisioned**.

```
RP/0/RP0/CPU0:ios#show hw-module location 0/1 mxponder
Fri Dec  6 02:50:32.858 UTC

Location:                0/1
Slice ID:                 0
Client Bitrate:          MIXED
Trunk Bitrate:           100G
Status:                Provisioned
LLDP Drop Enabled:      FALSE
Client Port              Mapper/Trunk Port   Peer/Trunk Port   OTU40/1/0/0
Traffic Split Percentage

OTU20/1/0/2/3            NONE                ODU20/1/0/0/2/3   100
OTU20/1/0/4/2            NONE                ODU20/1/0/0/4/2   100
OTU20/1/0/5/3            NONE                ODU20/1/0/0/5/3   100
OTU2E0/1/0/2/4           NONE                ODU2E0/1/0/0/2/4   100
OTU2E0/1/0/4/3           NONE                ODU2E0/1/0/0/4/3   100
OTU2E0/1/0/5/1           NONE                ODU2E0/1/0/0/5/1   100
OTU2E0/1/0/5/4           NONE                ODU2E0/1/0/0/5/4   100
TenGigEctr1r0/1/0/4/1    ODU2E0/1/0/0/4/1   NONE                100
TenGigEctr1r0/1/0/4/4    ODU2E0/1/0/0/4/4   NONE                100
TenGigEctr1r0/1/0/5/2    ODU2E0/1/0/0/5/2   NONE                100
```

### Checking the License Count

The following sample shows the license usage count as 1.

```
RP/0/RP0/CPU0:ios#show license all
Fri Dec  6 02:58:39.906 UTC

Smart Licensing Status
=====

Smart Licensing is ENABLED
```



```

Registration:
  Status: REGISTERED
  Smart Account: BU Production Test
  Virtual Account: NCS1000
  Export-Controlled Functionality: ALLOWED
  Initial Registration: SUCCEEDED on Dec 06 2019 02:54:27 UTC
  Last Renewal Attempt: None
  Next Renewal Attempt: Jun 03 2020 02:54:26 UTC
  Registration Expires: Dec 05 2020 02:49:42 UTC

License Authorization:
  Status: AUTHORIZED on Dec 06 2019 02:56:50 UTC
  Last Communication Attempt: SUCCEEDED on Dec 06 2019 02:56:50 UTC
  Next Communication Attempt: Dec 06 2019 14:56:49 UTC
  Communication Deadline: Mar 05 2020 02:52:06 UTC

Export Authorization Key:
  Features Authorized:
    <none>

Utility:
  Status: DISABLED
Data Privacy:
  Sending Hostname: yes
    Callhome hostname privacy: DISABLED
    Smart Licensing hostname privacy: DISABLED
  Version privacy: DISABLED

Transport:
  Type: Callhome

License Usage
=====
NCS 1K4 smart License - 100Gbps of client bandwidth (S-NCS1K4-100G-CL=):
  Description: 100G Client bandwidth - Smart License
  Count: 1
  Version: 1.0
  Status: Authorized
  Export status: NOT RESTRICTED

Product Information
=====
UDI: SN:CAT2217B025,UUID:default-sdr

Agent Version
=====
Smart Agent for Licensing: 4.10.4_rel/21

Reservation Info
=====
License reservation: DISABLED

```



---

**Note** The license count for 10GE, OTU2, and OTU2e is calculated as follows:

- If  $1 \leq$  number of client ports used  $\leq 10$ , it implies the "S-NCS1K4-100G-CL=" has license count of 1 and similarly if  $11 \leq$  number of client ports used  $\leq 20$ , it implies the "S-NCS1K4-100G-CL=" has license count of 2 and so on.
-





## CHAPTER 10

# USB Device Automount

---

This chapter describes the USB automount configuration on NCS 1004.

- [USB Automount, on page 241](#)
- [Mount USB Device, on page 241](#)
- [Unmount USB Device, on page 242](#)

## USB Automount

When you insert a USB device in NCS 1004, it is automatically mounted in sysadmin-vm with Read and Write permissions and unmounted in XR by default. The USB device is automatically mounted in sysadmin-vm only when the file system of the USB device is FAT or FAT32. This feature allows you to read from or write files and folders onto the USB device without explicitly mounting it. You can access the mounted USB device as disk2: file system.

Unmount the USB device from sysadmin-vm before you remove it from NCS 1004. Use the **mount** command, if you want to mount the USB device again after you unmount the device but before physically removing it.

You can simultaneously mount the USB device in XR-vm and sysadmin-vm. Unmount the USB device from both sysadmin-vm and XR-vm before you remove it from NCS 1004.

## Mount USB Device

To mount the USB device in sysadmin-vm, use the following command:

**usb device operation mount**

To mount the USB device in XR-vm, use the following command:

**unmount disk2: undo**

### Example

The following is an example of USB mount in sysadmin-vm.

```
sysadmin-vm:0_RP0#usb device operation mount
Fri Jul 13 09:26:00.821 UTC success usb mounted
```

The following is an example of USB mount in XR-vm.

```
RP/0/RP0/CPU0:ios#unmount disk2: undo
Fri Jul 13 14:56:34.326 IST
disk2: mounted successfully.
```

The following is an example of copying the file to the USB device.

```
[sysadmin-vm:0_RP0:~/showtech]$scp showtech-envmon-admin-2018-Jul-04.171400.IST.tgz /disk2\:
[sysadmin-vm:0_RP0:~/showtech]$cd /disk2\:
[sysadmin-vm:0_RP0:/disk2:]$ls -lrt
total 122424
drwxr-xr-x 2 root root      8192 Jul 12  2017 System Volume Information
drwxr-xr-x 2 root root      8192 Jun 11 16:16 boot
drwxr-xr-x 3 root root      8192 Jun 11 16:17 EFI
-rwxr-xr-x 1 root root 125306880 Jul 10 13:50 calvVarLog.tar
-rwxr-xr-x 1 root root    23023 Jul 13 05:23 showtech-envmon-admin-2018-Jul-04.171400.IST.tgz
```

## Unmount USB Device

To unmount the USB device in sysadmin-vm, use the following command:

**usb device operation unmount**

To unmount the USB device in XR-vm, use the following command:

**unmount disk2:**

### Example

The following is an example of USB unmount in sysadmin-vm.

```
sysadmin-vm:0_RP0#usb device operation unmount
Fri Jul 13 09:25:24.531 UTC success usb unmounted
```

The following is an example of USB unmount in XR-vm.

```
RP/0/RP0/CPU0:ios#unmount disk2:
Fri Jul 13 14:56:46.393 IST
disk2: unmounted successfully.
```



# CHAPTER 11

## Fault Profiles

---

This chapter describes how to configure and manage fault profiles.

- [Fault Profiles, on page 243](#)
- [Tasks for Configuring Fault Profiles, on page 244](#)
- [Configure Fault Profiles, on page 244](#)

## Fault Profiles

The default fault list in a system captures all the possible type of faults that the system generates, along with the associated default severity values, for each fault type. This default severity value is the severity of the fault that is generated in a system when no other fault profile is defined and applied in that system. Based on your requirement, you can create new fault profiles and change the severity of fault.

The Fault Profiling feature enables you to create a unique fault profile for faults on the system or the line card. Each fault profile can contain one or more faults with user-defined severities. The highest precedence is maintained at the port level and the lowest precedence is maintained at the system level. For example, if the system profile is already attached and if you want to have a separate fault profile for a node, you can create a node profile and attach it to that node. The node inherits the properties of the node profile. The available severity levels are:

- Major
- Minor
- Critical
- Non Faulted
- Non Reported

The defined set of actions for a fault profile are:

- Create and delete a fault profile
- Add alarms to a fault profile
- Remove alarms from a fault profile
- Modify severity of alarm in an existing profile

## Limitations of Fault Profiles

The following are the limitations for fault profiles on Cisco NCS 1004:

- Fault profiling is available only on data path alarms—Optics, Coherent DSP, Ethernet, and ODU alarms.
- Fault profiling at the port level is not supported.
- You can create a maximum of 61 profiles.

## Tasks for Configuring Fault Profiles

The following are the tasks for creating and configuring fault profiles:

- Create a fault profile with a unique name and a fault type.
- Add alarm names and severity level.
- Apply the fault profile at system-level or node-level.

## Configure Fault Profiles

This task has details of how to create a fault profile and apply the fault profile at the system or node level.

### configure

```
fault-profile fault_name fault identifier subsystem XR fault-type { ethernet | sdh_controller | sonet | HW_OPTICS | G709 | CPRI | OTS } fault-tag alarm_name severity { sas | nsas } severity_level
```

### commit

```
fault-profile fault-name apply rack rack_id slot { ALL | LC }
```

### commit

### exit

### Examples

The following sample creates a fault profile and applies at system level.

```
RP/0/RP0/CPU0:ios(config) fault-profile FpSystem fault-identifier subsystem XR fault-type
HW_OPTICS fault-tag OPTICAL_LO_RXPOWER sas NONFAULTED nsas NONFAULTED
RP/0/RP0/CPU0:ios(config) commit
RP/0/RP0/CPU0:ios(config) fault-profile FpSystem apply rack 0 slot ALL
RP/0/RP0/CPU0:ios(config) commit
```

The following sample creates a fault profile and applies at node level.

```
RP/0/RP0/CPU0:ios(config) fault-profile FpNode fault-identifier subsystem XR fault-type
HW_OPTICS fault-tag OPTICAL_LO_RXPOWER sas CRITICAL nsas CRITICAL
RP/0/RP0/CPU0:ios(config) commit
RP/0/RP0/CPU0:ios(config) fault-profile FpNode apply rack 0 slot LC1
RP/0/RP0/CPU0:ios(config) commit
```

The following sample creates a fault profile, configures one second PM and applies at propagation level.

```
RP/0/RP0/CPU0:ios(config) fault-profile OTNAlarm fault-identifier subsystem XR fault-type  
HW_G709 fault-tag G709_LOS sas CRITICAL nsas CRITICAL  
RP/0/RP0/CPU0:ios(config) commit  
RP/0/RP0/CPU0:ios(config) fault-profile OTNAlarm apply rack 0 slot ALL propagate  
RP/0/RP0/CPU0:ios(config) commit
```







# CHAPTER 12

## OC Support for AAA User

This chapter describes the implementation of the administrative model of *task-based authorization* used to control user access in the software system.

**Table 32: Feature History**

| Feature Name            | Release Information        | Feature Description                                                                                                                                                                                                                                                                                                                                                                                                                                                                                                                                                              |
|-------------------------|----------------------------|----------------------------------------------------------------------------------------------------------------------------------------------------------------------------------------------------------------------------------------------------------------------------------------------------------------------------------------------------------------------------------------------------------------------------------------------------------------------------------------------------------------------------------------------------------------------------------|
| OC support for AAA user | Cisco IOS XR Release 7.3.2 | <p>This feature allows all authorized users on XR VM to access administration data on the router through NETCONF or gRPC interface, similar to accessing the CLI. This functionality works by internally mapping the task group of the user on XR VM to a predefined group on System Admin VM. Therefore, the NETCONF and gRPC users can access the administrative information on the router even if their user profiles do not exist on System Admin VM.</p> <p>Command added:</p> <ul style="list-style-type: none"><li>• <b>aaa authorization (System Admin-VM)</b></li></ul> |

- [Understanding of AAA, on page 247](#)
- [Admin Access for NETCONF and gRPC, on page 248](#)

## Understanding of AAA

User groups and task groups are configured through the software command set used for authentication, authorization and accounting (AAA) services. Authentication commands are used to verify the identity of a user or principal. Authorization commands are used to verify that an authenticated user (or principal) is granted permission to perform a specific task. Accounting commands are used for logging of sessions and to create an audit trail by recording certain user- or system-generated actions.

AAA is part of the software base package and is available by default.

To configure authentication, authorization, and accounting (AAA) authentication at login, use the **aaa authentication login** command in global configuration mode.

## Admin Access for NETCONF and gRPC

This feature allows all authorized users on XR VM to access administration data on the router through NETCONF or gRPC interface, similar to accessing the CLI. This functionality works by internally mapping the task group of the user on XR VM to a predefined group on System Admin VM. Therefore, the NETCONF and gRPC users can access the admin-related information on the router even if their user profiles do not exist on System Admin VM.

NETCONF is an XML-based protocol used over Secure Shell (SSH) transport to configure a network. Similarly, gRPC is an open-source remote procedure call framework. The client applications can use these protocols to request information from the router and make configuration changes to the router. Prior to Cisco IOS XR Software Release 7.3.2, users who use NETCONF, gRPC or any other configuration interface, other than CLI, to access the admin-related information on the router, had to belong to user groups that are configured on System Admin VM. Otherwise, the router would issue an UNAUTHORIZED access error message and deny access through that client interface.

By default, XR VM synchronizes only the first configured user to System Admin VM. If you delete the first user in XR VM, the system synchronizes the next user in the **root-lr** group (which is the highest privilege group in XR VM for Cisco IOS XR 64-bit platforms) to System Admin VM only if there are no other users configured in System Admin VM. The system does not automatically synchronize the subsequent users to System Admin VM. Therefore, in earlier releases, users whose profiles did not exist in System Admin VM were not able to perform any NETCONF or gRPC operations on System Admin VM.

From Cisco IOS XR Software Release 7.3.2, the system internally maps the users who are authorized on XR VM to System Admin VM of the router, based on the task table of the user on XR VM. With this feature, the NETCONF and gRPC users can access admin-related information on the router even if their user profiles do not exist on System Admin VM. By default, this feature is enabled.

## User Profile Mapping from XR VM to System Admin VM

User privileges to execute commands and access data elements on the router are usually specified using certain command rules and data rules that are created and applied on the user groups.

When the internal process for AAA starts or when you create the first user, the system creates the following set of predefined groups, command rules and data rules in System Admin VM. These configurations are prepopulated to allow users of different groups (such as root-system, admin-r and aaa-r) in System Admin VM

You can use the **show running-configuration aaa** command to view the AAA configurations.

```
aaa authentication groups group aaa-r gid 100 users %%__system_user__%%
!
aaa authentication groups group admin-r gid 100 users %%__system_user__%%
!
aaa authentication groups group root-system gid 100 users "%%__system_user__%% "
!
aaa authorization cmdrules cmdrule 1 context * command * group root-system ops rx action
accept
!
aaa authorization cmdrules cmdrule 2 context * command "show running-config aaa" group aaa-r
```

```

ops rx action accept
!
aaa authorization cmdrules cmdrule 3 context * command "show tech-support aaa" group aaa-r
ops rx action accept
!
aaa authorization cmdrules cmdrule 4 context * command "show aaa" group aaa-r ops rx
action accept
!
aaa authorization cmdrules cmdrule 5 context * command show group admin-r ops rx action
accept
!
aaa authorization datarules datarule 1 namespace * context * keypath * group root-system
ops rx action accept
!
aaa authorization datarules datarule 2 namespace * context * keypath /aaa group aaa-r ops
r action accept
!
aaa authorization datarules datarule 3 namespace * context * keypath /aaa group admin-r ops
rx action reject
!
aaa authorization datarules datarule 4 namespace * context * keypath / group admin-r ops r
action accept

```

The admin CLI for the user works based on the above configurations. The root-system is the group with the highest privilege in System Admin VM. The admin-r group has only read and execute access to all data. The aaa-r group has access only to AAA data. With the introduction of the admin access feature for all users, the NETCONF and gRPC applications can also access the admin data based on the above rules and groups.

## How to Allow Read Access to Administration Data for NETCONF and gRPC Clients

NETCONF and gRPC users access the administration data on the router through GET operations as defined by the respective protocols. To allow this read access to administration data for users belonging to admin-r group, you must configure a new command rule specifically for the NETCONF or gRPC client.

### Configuration Example

```

Router#admin
sysadmin-vm:0_RP0#configure
sysadmin-vm:0_RP0(config)#aaa authorization cmdrules cmdrule 6
sysadmin-vm:0_RP0(config-cmdrule-6)#context netconf
sysadmin-vm:0_RP0(config-cmdrule-6)#command get
sysadmin-vm:0_RP0(config-cmdrule-6)#group admin-r
sysadmin-vm:0_RP0(config-cmdrule-6)#ops rx
sysadmin-vm:0_RP0(config-cmdrule-6)#action accept
sysadmin-vm:0_RP0(config)#commit

```

### Running Configuration

```

aaa authorization cmdrules cmdrule 6
context netconf
command get
group admin-r
ops rx
action accept
!

```





## APPENDIX **A**

# SNMP

---

NCS 1004 supports the following MIBs.

- CISCO-AM-SNMP-MIB
- CISCO-CONFIG-MAN-MIB
- CISCO-FLASH-MIB
- CISCO-ENTITY-REDUNDANCY-MIB
- CISCO-SYSTEM-MIB
- CISCO-ENTITY-ASSET-MIB
- EVENT-MIB
- DISMAN-EXPRESSION-MIB
- CISCO-FTP-CLIENT-MIB
- NOTIFICATION-LOG-MIB
- CISCO-RF-MIB
- RADIUS-AUTH-CLIENT-MIB
- RADIUS-ACC-CLIENT-MIB
- IEEE8023-LAG-MIB
- CISCO-TCP-MIB
- UDP-MIB
- CISCO-BULK-FILE-MIB
- CISCO-CONTEXT-MAPPING-MIB
- CISCO-OTN-IF-MIB
- CISCO-ENHANCED-MEMPOOL-MIB
- CISCO-PROCESS-MIB
- CISCO-SYSLOG-MIB

- ENTITY-MIB
- CISCO-ENTITY-FRU-CONTROL-MIB
- CISCO-IF-EXTENSION-MIB
- RMON-MIB
- HC-RMON-MIB
- CISCO-OPTICAL-MIB
- CISCO-ENTITY-SENSOR-MIB
- LLDP-MIB
- CISCO-ALARM-MIB

The following table provides more information about SNMP MIBs and related documentation links.

| Task                                                                                                                                   | Link                                  |
|----------------------------------------------------------------------------------------------------------------------------------------|---------------------------------------|
| Determine the MIB definitions                                                                                                          | <a href="#">SNMP Object Navigator</a> |
| Configure SNMP                                                                                                                         | <a href="#">Configure SNMP</a>        |
| Understand SNMP best practices about the recommended order of SNMP query, maximum cache hit, and SNMP retry and timeout recommendation | <a href="#">SNMP Best Practices</a>   |

Make sure that you configure `snmp-server community` as the `SystemOwner` to have the admin-plane parameters to appear to entity MIB. The parameters of fans and power supply units are examples of admin-plane parameters.