



MPLS Traffic Engineering--Fast Reroute Link and Node Protection

The MPLS Traffic Engineering--Fast Reroute Link and Node Protection feature provides link protection (backup tunnels that bypass only a single link of the label-switched path (LSP)), node protection (backup tunnels that bypass next-hop nodes along LSPs), and Fast Reroute (FRR) features.

- [Finding Feature Information, page 1](#)
- [Prerequisites for MPLS Traffic Engineering--Fast Reroute Link and Node Protection , page 2](#)
- [Restrictions for MPLS Traffic Engineering--Fast Reroute Link and Node Protection , page 2](#)
- [Information About MPLS Traffic Engineering--Fast Reroute Link and Node Protection , page 3](#)
- [How to Configure MPLS Traffic Engineering—Fast Reroute Link and Node Protection, page 17](#)
- [Configuration Examples for MPLS Traffic Engineering—Fast Reroute Link and Node Protection, page 33](#)
- [Additional References, page 36](#)
- [Command Reference, page 37](#)
- [Feature Information for MPLS Traffic Engineering—Fast Reroute Link and Node Protection , page 38](#)
- [Glossary, page 41](#)

Finding Feature Information

Your software release may not support all the features documented in this module. For the latest caveats and feature information, see [Bug Search Tool](#) and the release notes for your platform and software release. To find information about the features documented in this module, and to see a list of the releases in which each feature is supported, see the feature information table at the end of this module.

Use Cisco Feature Navigator to find information about platform support and Cisco software image support. To access Cisco Feature Navigator, go to www.cisco.com/go/cfn. An account on Cisco.com is not required.

Prerequisites for MPLS Traffic Engineering--Fast Reroute Link and Node Protection

Your network must support the following Cisco IOS features:

- IP Cisco Express Forwarding
- Multiprotocol Label Switching (MPLS)

Your network must support at least one of the following protocols:

- Intermediate System-to-Intermediate System (IS-IS)
- Open Shortest Path First (OSPF)

Before configuring FRR link and node protection, it is assumed that you have done the following tasks but you do not have to already have configured MPLS traffic engineering (TE) tunnels:

- Enabled MPLS TE on all relevant routers and interfaces
- Configured MPLS TE tunnels

Restrictions for MPLS Traffic Engineering--Fast Reroute Link and Node Protection

- Interfaces must use MPLS Global Label Allocation.
- Backup tunnel headend and tailend routers must implement FRR as described in draft-pan-rsvp-fastreroute-00.txt.
- Backup tunnels are not protected. If an LSP is actively using a backup tunnel and the backup tunnel fails, the LSP is torn down.
- LSPs that are actively using backup tunnels are not considered for promotion. If an LSP is actively using a backup tunnel and a better backup tunnel becomes available, the active LSP is not switched to the better backup tunnel.
- You cannot enable FRR Hellos on a router that also has Resource Reservation Protocol (RSVP) Graceful Restart enabled.
- (Applicable only to Release 12.2.) You cannot enable primary one-hop autotunnels, backup autotunnels, or autotunnel mesh groups on a router that is also configured with stateful switchover (SSO) redundancy. This restriction does not prevent an MPLS TE tunnel that is automatically configured by TE autotunnel from being successfully recovered by any midpoint router along the LSP's path if the router experiences an SSO switchover.
- MPLS TE LSPs that are fast reroutable cannot be successfully recovered if the LSPs are FRR active and the Point of Local Repair (PLR) router experiences an SSO.
- When SSO (stateful switchover) occurs on a router, the switchover process must complete before FRR (fast reroute) can complete successfully. In a testing environment, allow approximately 2 minutes for

TE SSO recovery to complete before manually triggering FRR. To check the TE SSO status, use the **show ip rsvp high-availability summary** command. Note the status of the HA state field.

- When SSO is in the process of completing, this field will display 'Recovering'.
- When the SSO process has completed, this field will display 'Active'.

Information About MPLS Traffic Engineering--Fast Reroute Link and Node Protection

Fast Reroute

Fast Reroute (FRR) is a mechanism for protecting MPLS TE LSPs from link and node failures by locally repairing the LSPs at the point of failure, allowing data to continue to flow on them while their headend routers attempt to establish new end-to-end LSPs to replace them. FRR locally repairs the protected LSPs by rerouting them over backup tunnels that bypass failed links or node.

Link Protection

Backup tunnels that bypass only a single link of the LSP's path provide link protection. They protect LSPs if a link along their path fails by rerouting the LSP's traffic to the next hop (bypassing the failed link). These are referred to as next-hop (NHOP) backup tunnels because they terminate at the LSP's next hop beyond the point of failure. The figure below illustrates an NHOP backup tunnel.

Figure 1: NHOP Backup Tunnel

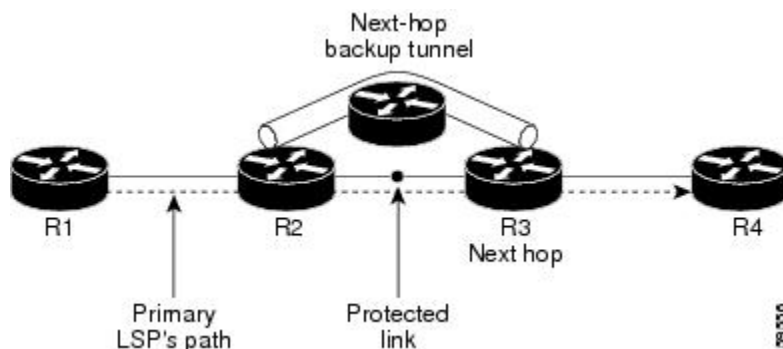

Node Protection

FRR provides node protection for LSPs. Backup tunnels that bypass next-hop nodes along LSP paths are called next-next-hop (NNHOP) backup tunnels because they terminate at the node following the next-hop node of the LSP paths, thereby bypassing the next-hop node. They protect LSPs if a node along their path fails by enabling the node upstream of the failure to reroute the LSPs and their traffic around the failed node.

to the next-next hop. FRR supports the use of RSVP Hellos to accelerate the detection of node failures. NNHOP backup tunnels also provide protection from link failures, because they bypass the failed link and the node. The figure below illustrates an NNHOP backup tunnel.

Figure 2: NNHOP Backup Tunnel

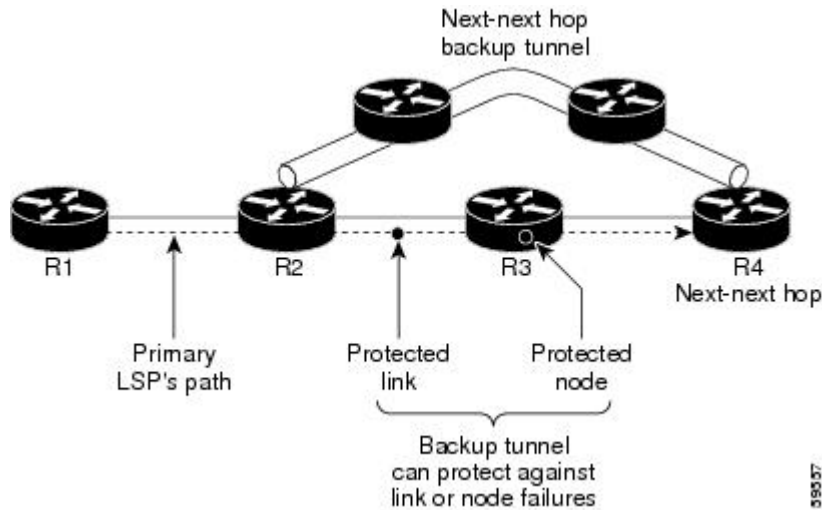

If an LSP is using a backup tunnel and something changes so that the LSP is no longer appropriate for the backup tunnel, the LSP is torn down. Such changes are the following:

- Backup bandwidth of the backup tunnel is reduced.
- Backup bandwidth type of backup tunnel is changed to a type that is incompatible with the primary LSP.
- Primary LSP is modified so that FRR is disabled. (The `no mpls traffic-eng fast-reroute` command is entered.)

Bandwidth Protection

NHOP and NNHOP backup tunnels can be used to provide bandwidth protection for rerouted LSPs. This is referred to as backup bandwidth. You can associate backup bandwidth with NHOP or NNHOP backup tunnels. This informs the router of the amount of backup bandwidth a particular backup tunnel can protect. When a router maps LSPs to backup tunnels, bandwidth protection ensures that an LSP uses a given backup tunnel only if there is sufficient backup bandwidth. The router selects which LSPs use which backup tunnels in order to provide maximum bandwidth protection. That is, the router determines the best way to map LSPs onto backup tunnels in order to maximize the number of LSPs that can be protected. For information about mapping tunnels and assigning backup bandwidth, see the [Backup Tunnel Selection Procedure](#).

LSPs that have the “bandwidth protection desired” bit set have a higher right to select backup tunnels that provide bandwidth protection; that is, those LSPs can preempt other LSPs that do not have that bit set. For more information, see the [Bandwidth Protection](#), on page 4.

RSVP Hello

RSVP Hello Operation

RSVP Hello enables RSVP nodes to detect when a neighboring node is not reachable. This provides node-to-node failure detection. When such a failure is detected, it is handled in a similar manner as a link-layer communication failure.

RSVP Hello can be used by FRR when notification of link-layer failures is not available (for example, with Ethernet), or when the failure detection mechanisms provided by the link layer are not sufficient for the timely detection of node failures.

A node running Hello sends a Hello Request to a neighboring node every interval. If the receiving node is running Hello, it responds with Hello Ack. If four intervals pass and the sending node has not received an Ack or it receives a bad message, the sending node declares that the neighbor is down and notifies FRR.

There are two configurable parameters:

- Hello interval--Use the **ip rsvp signalling hello refresh interval** command.
- Number of acknowledgment messages that are missed before the sending node declares that the neighbor is down--Use the **ip rsvp signalling hello refresh misses** command

Hello Instance

A Hello instance implements RSVP Hello for a given router interface IP address and remote IP address. A large number of Hello requests are sent; this puts a strain on the router resources. Therefore, create a Hello instance only when it is necessary and delete it when it is no longer needed.

There are two types of Hello instances:

- [Hello Instance, on page 5](#)
- [Hello Instance, on page 5](#)

Active Hello Instances

If a neighbor is unreachable when an LSP is ready to be fast rerouted, an active Hello instance is needed. Create an active Hello instance for each neighbor with at least one LSP in this state.

Active Hello instances periodically send Hello Request messages, and expect Hello Ack messages in response. If the expected Ack message is not received, the active Hello instance declares that the neighbor (remote IP address) is unreachable (lost). LSPs traversing that neighbor may be fast rerouted.

If there is a Hello instance with no LSPs for an unreachable neighbor, do not delete the Hello instance. Convert the active Hello instance to a passive Hello instance because there may be an active instance on the neighboring router that is sending Hello requests to this instance.

Passive Hello Instances

Passive Hello instances respond to Hello Request messages (sending Ack messages), but do not initiate Hello Request messages and do not cause LSPs to be fast rerouted. A router with multiple interfaces can run multiple Hello instances to different neighbors or to the same neighbor.

A passive Hello instance is created when a Hello Request is received from a neighbor with a source IP address/destination IP address pair in the IP header for which a Hello instance does not exist.

Delete passive instances if no Hello messages are received for this instance within 10 minutes.

Features of MPLS Traffic Engineering--Fast Reroute Link and Node Protection

Backup Tunnel Support

Backup tunnel support has the following capabilities:

Backup Tunnels Can Terminate at the Next-Next Hop to Support FRR

Backup tunnel that terminates at the next-next hop router to protect both the downstream link and node to protect link and node failures. For more detailed information, see the [Node Protection](#).

Multiple Backup Tunnels Can Protect the Same Interface

There is no limit (except memory limitations) to the number of backup tunnels that can protect a given interface. In many topologies, support for Node Protection requires supporting multiple backup tunnels per protected interface. These backup tunnels can terminate at the same destination or at different destinations. That is, for a given protected interface, you can configure multiple NHOP or NNHOP backup tunnels. This allows redundancy and load balancing.

In addition to being required for Node Protection, this feature provides the following benefits:

- Redundancy--If one backup tunnel is down, other backup tunnels protect LSPs.
- Increased backup capacity--If the protected interface is a high-capacity link and no single backup path exists with an equal capacity, multiple backup tunnels can protect that one high-capacity link. The LSPs using this link will fail over to different backup tunnels, allowing all of the LSPs to have adequate bandwidth protection during failure (rerouting). If bandwidth protection is not desired, the router spreads LSPs across all available backup tunnels (that is, there is load balancing across backup tunnels). For a more detailed explanation, see the [Backup Tunnel Selection Procedure](#).

Examples are shown in the [Backup Tunnels Terminating at Different Destinations](#) and the [Backup Tunnels Terminating at the Same Destination](#).

Scalability

A backup tunnel is scalable because it can protect multiple LSPs and multiple interfaces. It provides many-to-one (N:1) protection, which has significant scalability advantages over one-to-one (1:1) protection, where a separate backup tunnel must be used for each LSP needing protection.

Example of 1:1 protection: When 5,000 backup tunnels protect 5,000 LSPs, each router along the backup path must maintain state for an additional 5,000 tunnels.

Example of N:1 protection: When one backup tunnel protects 5,000 LSPs, each router along the backup path maintains one additional tunnel.

Backup Bandwidth Protection

Backup bandwidth protection allows you to give LSPs carrying certain kinds of data (such as voice) priority for using backup tunnels. Backup bandwidth protection has the following capabilities:

Bandwidth Protection on Backup Tunnels

Rerouted LSPs not only have their packets delivered during a failure, but the quality of service can also be maintained.

Bandwidth Pool Specifications for Backup Tunnels

You can restrict the types of LSPs that can use a given backup tunnel. Backup tunnels can be restricted so that only LSPs using subpool bandwidth can use them or only LSPs that use global-pool bandwidth can use them. This allows different backup tunnels to be used for voice and data. Example: The backup tunnel used for voice could provide bandwidth protection, and the backup tunnel used for data could not provide bandwidth protection.

Semidynamic Backup Tunnel Paths

The path of a backup tunnel can be configured to be determined dynamically. This can be done by using the IP explicit address exclusion feature that was added in Release 12.0(14)ST. If you use this feature, semidynamic NHOP backup tunnel paths can be specified simply by excluding the protected link; semidynamic NNHOP backup tunnel paths can be configured simply by excluding the protected node.

Prioritizing Which LSPs Obtain Backup Tunnels with Bandwidth Protection

In case there are not enough NHOP or NNHOP backup tunnels or they do not have enough backup bandwidth to protect all LSPs, you can give an LSP priority in obtaining backup tunnels with bandwidth protection. This is especially useful if you want to give LSPs carrying voice a higher priority than those carrying data.

To activate this feature, enter the **tunnel mpls traffic-eng fast-reroute bw-protect** command to set the “bandwidth protection desired” bit. See the [Enabling Fast Reroute on LSPs, on page 17](#).

The LSPs do not necessarily receive bandwidth protection. They have a higher chance of receiving bandwidth protection if they need it.

LSPs that do not have the bandwidth protection bit set can be demoted. Demotion is when one or more LSPs are removed from their assigned backup tunnel to provide backup to an LSP that has its bandwidth protection bit set. Demotion occurs only when there is a scarcity of backup bandwidth.

When an LSP is demoted, it becomes unprotected (that is, it no longer has a backup tunnel). During the next periodic promotion cycle, an attempt is made to find the best possible backup tunnels for all LSPs that do not currently have protection, including the LSP that was demoted. The LSP may get protection at the same level or a lower level, or it may get no protection.

For information about how routers determine which LSPs to demote, see the [Backup Bandwidth Protection, on page 7](#).

RSVP Hello

RSVP Hello enables a router to detect when a neighboring node has gone down but its interface to that neighbor is still operational. This feature is useful when next-hop node failure is not detectable by link layer mechanisms,

or when notification of link-layer failures is not available (for example, Gigabit Ethernet). This allows the router to switch LSPs onto its backup tunnels and avoid packet loss.

For a more detailed description of RSVP Hello, see the [RSVP Hello](#), on page 5.

Fast Reroute Operation

This section describes the following:

Fast Reroute Activation

Two mechanisms cause routers to switch LSPs onto their backup tunnels:

- Interface down notification
- RSVP Hello neighbor down notification

When a router's link or neighboring node fails, the router often detects this failure by an interface down notification. On a GSR Packet over SONET (PoS) interface, this notification is very fast. When a router notices that an interface has gone down, it switches LSPs going out that interface onto their respective backup tunnels (if any).

RSVP Hellos can also be used to trigger FRR. If RSVP Hellos are configured on an interface, messages are periodically sent to the neighboring router. If no response is received, Hellos declare that the neighbor is down. This causes any LSPs going out that interface to be switched to their respective backup tunnels.

Backup Tunnels Terminating at Different Destinations

The figure below illustrates an interface that has multiple backup tunnels terminating at different destinations and demonstrates why, in many topologies, support for node protection requires supporting multiple backup tunnels per protected interface.

Figure 3: Backup Tunnels That Terminate at Different Destinations

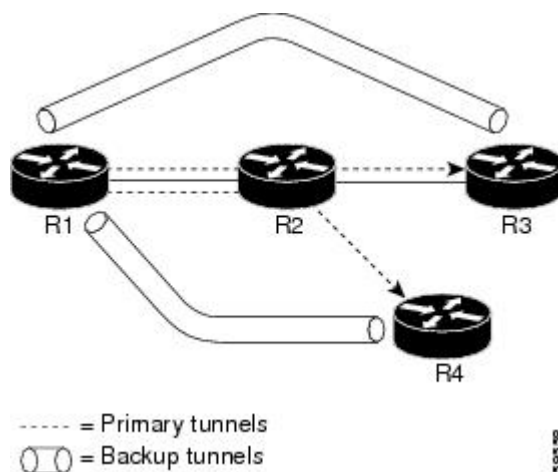

In this illustration, a single interface on R1 requires multiple backup tunnels. LSPs traverse the following routes:

- R1, R2, R3
- R1, R2, R4

To provide protection if node R2 fails, two NNHOP backup tunnels are required: one terminating at R3 and one terminating at R4.

Backup Tunnels Terminating at the Same Destination

The figure below shows how backup tunnels terminating at the same location can be used for redundancy and load balancing. Redundancy and load balancing work for both NHOP and NNHOP backup tunnels.

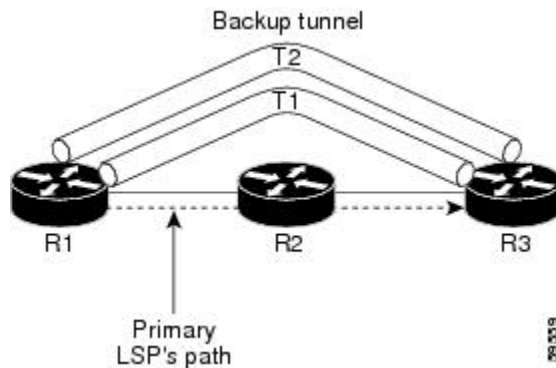

In this illustration, there are three routers: R1, R2, and R3. At R1 two NNHOP backup tunnels (T1 and T2) go from R1 to R3 without traversing R2.

Redundancy--If R2 fails or the link from R1 to R2 fails, either backup tunnel can be used. If one backup tunnel is down, the other can be used. LSPs are assigned to backup tunnels when the LSPs are first established. This is done before a failure.

Load balancing--If neither backup tunnel has enough bandwidth to back up all LSPs, both tunnels can be used. Some LSPs will use one backup tunnel, other LSPs will use the other backup tunnel. The router decides the best way to fit the LSPs onto the backup tunnels.

Backup Tunnel Selection Procedure

When an LSP is signaled, each node along the LSP path that provides FRR protection for the LSP selects a backup tunnel for the LSP to use if either of the following events occurs:

- The link to the next hop fails.
- The next hop fails.

By having the node select the backup tunnel for an LSP before a failure occurs, the LSP can be rerouted onto the backup tunnel quickly if there is a failure.

For an LSP to be mapped to a backup tunnel, all of the following conditions must exist:

- The LSP is protected by FRR; that is, the LSP is configured with the **tunnel mpls traffic-eng fast-reroute** command.
- The backup tunnel is up.

- The backup tunnel is configured to have an IP address, typically a loopback address.
- The backup tunnel is configured to protect this LSP's outgoing interface; that is, the interface is configured with the **mpls traffic-eng backup-path** command.
- The backup tunnel does not traverse the LSP's protected interface.
- The backup tunnel terminates at the LSP's NHOP or NNHOP. If it is an NNHOP tunnel, it does not traverse the LSP's NHOP.
- The bandwidth protection requirements and constraints, if any, for the LSP and backup tunnel are met. For information about bandwidth protection considerations, see the [Bandwidth Protection](#), on page 10.

Bandwidth Protection

A backup tunnel can be configured to protect two types of backup bandwidth:

- Limited backup bandwidth--A backup tunnel provides bandwidth protection. The sum of the bandwidth of all LSPs using this backup tunnel cannot exceed the backup tunnel's backup bandwidth. When you assign LSPs to this type of backup tunnel, sufficient backup bandwidth must exist.
- Unlimited backup bandwidth--The backup tunnel does not provide any bandwidth protection (that is, best-effort protection exists). There is no limit to the amount of bandwidth used by the LSPs that are mapped to this backup tunnel. LSPs that allocate zero bandwidth can use only backup tunnels that have unlimited backup bandwidth.

Load Balancing on Limited-Bandwidth Backup Tunnels

There may be more than one backup tunnel that has sufficient backup bandwidth to protect a given LSP. In this case, the router chooses the one that has the least amount of backup bandwidth available. This algorithm limits fragmentation, maintaining the largest amount of backup bandwidth available.

Specifying limited backup bandwidth does not "guarantee" bandwidth protection if there is a link or node failure. For example, the set of NHOP and NNHOP backup tunnels that gets triggered when an interface fails may all share some link on the network topology, and this link may not have sufficient bandwidth to support all LSPs using this set of backup tunnels.

In the figure below, both backup tunnels traverse the same links and hop. When the link between routers R1 and R4 fails, backup tunnels for primary tunnel 1 and primary tunnel 2 are triggered simultaneously. The two backup tunnels may share a link in the network.

Figure 4: Backup Tunnels Share a Link

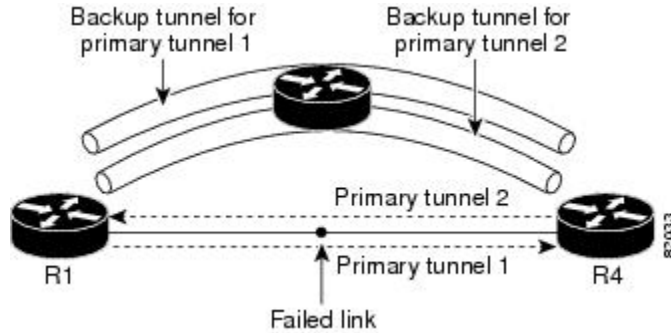

In the figure below, the backup tunnel for primary tunnel 1 may traverse routers R1-R2-R3-R4, and the backup tunnel for primary tunnel 2 may traverse routers R4-R2-R3-R1. In this case, the link R2-R3 may get overloaded if R1-R4 fails.

Figure 5: Overloaded Link

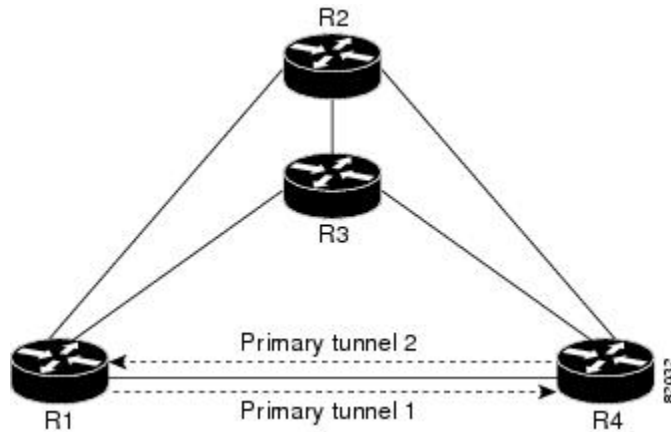

Load Balancing on Unlimited-Bandwidth Backup Tunnels

More than one backup tunnel, each having unlimited backup bandwidth, can protect a given interface. In this case, when choosing a backup tunnel for a given LSP, the router chooses the backup tunnel that has the least amount of backup bandwidth in use. This algorithm evenly distributes the LSPs across backup tunnels based on an LSP's bandwidth. If an LSP is requesting zero bandwidth, the router chooses the backup tunnel that is protecting the fewest LSPs.

Pool Type and Backup Tunnels

By default, a backup tunnel provides protection for LSPs that allocate from any pool (that is, global or subpool). However, a backup tunnel can be configured to protect only LSPs that use global-pool bandwidth, or only those that use subpool bandwidth.

Tunnel Selection Priorities

This section describes the following:

NHOP Versus NNHOP Backup Tunnels

More than one backup tunnel can protect a given LSP, where one backup tunnel terminates at the LSP's NNHOP, and the other terminates at the LSP's NHOP. In this case, the router chooses the backup tunnel that terminates at the NNHOP (that is, FRR prefers NNHOP over NHOP backup tunnels).

The table below lists the tunnel selection priorities. The first choice is an NNHOP backup tunnel that acquires its bandwidth from a subpool or global pool, and has limited bandwidth. If there is no such backup tunnel, the next choice (2) is a next-next hop backup tunnel that acquires a limited amount of bandwidth from any pool. The preferences go from 1 (best) to 8 (worst), where choice 3 is for an NNHOP backup tunnel with an unlimited amount of subpool or global-pool bandwidth.

Table 1: Tunnel Selection Priorities

Preference	Backup Tunnel Destination	Bandwidth Pool	Bandwidth Amount
1 (Best)	NNHOP	Subpool or global pool	Limited
2	NNHOP	Any	Limited
3	NNHOP	Subpool or global pool	Unlimited
4	NNHOP	Any	Unlimited
5	NHOP	Subpool or global pool	Limited
6	NHOP	Any	Limited
7	NHOP	Subpool or global pool	Unlimited
8 (Worst)	NHOP	Any	Unlimited

The figure below shows an example of the backup tunnel selection procedure based on the designated amount of global pool and subpool bandwidth currently available.

**Note**

If NHOP and NNHOP backup tunnels do not have sufficient backup bandwidth, no consideration is given to the type of data that the LSP is carrying. For example, a voice LSP may not be protected unless it is signaled before a data LSP. To prioritize backup tunnel usage, see the "Backup Protection Preemption Algorithms" section.

Figure 6: Choosing from Among Multiple Backup Tunnels

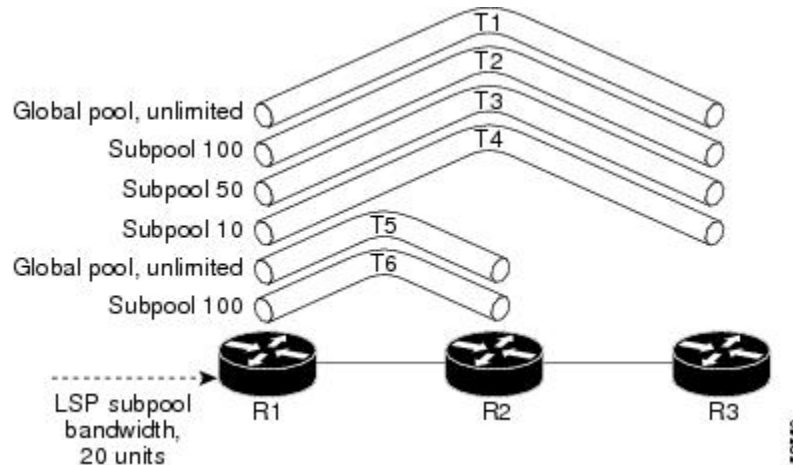

In this example, an LSP requires 20 units (kilobits per second) of sub-pool backup bandwidth. The best backup tunnel is selected as follows:

- 1 Backup tunnels T1 through T4 are considered first because they terminate at the NNHOP.
- 2 Tunnel T4 is eliminated because it has only ten units of sub-pool backup bandwidth.
- 3 Tunnel T1 is eliminated because it protects only LSPs using global-pool bandwidth.
- 4 Tunnel T3 is chosen over T2 because, although both have sufficient backup bandwidth, T3 has the least backup bandwidth available (leaving the most backup bandwidth available on T2).
- 5 Tunnels T5 and T6 need not be considered because they terminate at an NHOP, and therefore are less desirable than T3, which terminates at an NNHOP.

Promotion

After a backup tunnel has been chosen for an LSP, conditions may change that will cause us to reevaluate this choice. This reevaluation, if successful, is called promotion. Such conditions may include:

- 1 A new backup tunnel comes up.
- 2 The currently chosen backup tunnel for this LSP goes down.
- 3 A backup tunnel's available backup bandwidth increases. For example, an LSP protected by the tunnel has been reoptimized by the headend to use another path.

For cases 1 and 2, the LSP's backup tunnel is evaluated immediately. Case 3 is addressed by periodically reevaluating LSP-to-backup tunnel mappings. By default, background reevaluation is performed every 5 minutes. This interval is configurable via the **mpls traffic-eng fast-reroute timers** command.

Backup Protection Preemption Algorithms

When you set the "bandwidth protection desired" bit for an LSP, the LSP has a higher right to select backup tunnels that provide bandwidth protection and it can preempt other LSPs that do not have that bit set.

If there is insufficient backup bandwidth on NNHOP backup tunnels but not on NHOP backup tunnels, the bandwidth-protected LSP does not preempt NNHOP LSPs; it uses NHOP protection.

If there are multiple LSPs using a given backup tunnel and one or more must be demoted to provide bandwidth, there are two user-configurable methods (algorithms) that the router can use to determine which LSPs are demoted:

- Minimize amount of bandwidth that is wasted.
- Minimize the number of LSPs that are demoted.

For example, If you need ten units of backup bandwidth on a backup tunnel, you can demote one of the following:

- A single LSP using 100 units of bandwidth--Makes available more bandwidth than needed, but results in lots of waste
- Ten LSPs, each using one unit of bandwidth--Results in no wasted bandwidth, but affects more LSPs

The default algorithm is to minimize the number of LSPs that are demoted. To change the algorithm to minimize the amount of bandwidth that is wasted, enter the **mpls traffic-eng fast-reroute backup-prot-preemption optimize-bw** command.

Bandwidth Protection Considerations

There are numerous ways in which bandwidth protection can be ensured. The table below describes the advantages and disadvantages of three methods.

Table 2: Bandwidth Protection Methods

Method	Advantages	Disadvantages
Reserve bandwidth for backup tunnels explicitly.	It is simple.	It is a challenge to allow bandwidth sharing of backup tunnels protecting against independent failures.
Use backup tunnels that are signaled with zero bandwidth.	It provides a way to share bandwidth used for protection against independent failures, so it ensures more economical bandwidth usage.	It may be complicated to determine the proper placement of zero bandwidth tunnels.

Method	Advantages	Disadvantages
Backup bandwidth protection.	It ensures bandwidth protection for voice traffic.	An LSP that does not have backup bandwidth protection can be demoted at any time if there is not enough backup bandwidth and an LSP that has backup bandwidth protection needs bandwidth.

Cisco implementation of FRR does not mandate a particular approach, and it provides the flexibility to use any of the above approaches. However, given a range of configuration choices, be sure that the choices are constant with a particular bandwidth protection strategy.

The following sections describe some important issues in choosing an appropriate configuration:

Using Backup Tunnels with Explicitly Signaled Bandwidth

Two bandwidth parameters must be set for a backup tunnel:

- Actual signaled bandwidth
- Backup bandwidth

To signal bandwidth requirements of a backup tunnel, configure the bandwidth of the backup tunnel by using the **tunnel mpls traffic-eng bandwidth** command.

To configure the backup bandwidth of the backup tunnel, use the **tunnel mpls traffic-eng backup-bw** command.

The signaled bandwidth is used by the LSRs on the path of the backup tunnel to perform admission control and do appropriate bandwidth accounting.

The backup bandwidth is used by the point of local repair (PLR) (that is, the headend of the backup tunnel) to decide how much primary traffic can be rerouted to this backup tunnel if there is a failure.

Both parameters need to be set to ensure proper operation. The numerical value of the signaled bandwidth and the backup bandwidth should be the same.

Protected Bandwidth Pools and the Bandwidth Pool from Which the Backup Tunnel Reserves Its Bandwidth

The **tunnel mpls traffic-eng bandwidth** command allows you to configure the following:

- Amount of bandwidth a backup tunnel reserves
- The DS-TE bandwidth pool from which the bandwidth needs to be reserved



Note

Only one pool can be selected (that is, the backup tunnel can explicitly reserve bandwidth from either the global pool or the subpool, but not both).

The **tunnel mpls traffic-eng backup-bw** command allows you to specify the bandwidth pool to which the traffic must belong for the traffic to use this backup tunnel. Multiple pools are allowed.

There is no direct correspondence between the bandwidth pool that is protected and the bandwidth pool from which the bandwidth of the backup tunnel draws its bandwidth.

Bandwidth protection for 10 Kbps of subpool traffic on a given link can be achieved by configuring any of the following command combinations:

- **tunnel mpls traffic-eng bandwidth sub-pool 10**

tunnel mpls traffic-eng backup-bw sub-pool 10

- **tunnel mpls traffic-eng bandwidth global-pool 10**

tunnel mpls traffic-eng backup-bw sub-pool 10 global-pool unlimited

- **tunnel mpls traffic-eng bandwidth global-pool 40**

tunnel mpls traffic-eng backup-bw sub-pool 10 global-pool 30

Using Backup Tunnels Signaled with Zero Bandwidth

Frequently it is desirable to use backup tunnels with zero signaled bandwidth, even when bandwidth protection is required. It may seem that if no bandwidth is explicitly reserved, no bandwidth guarantees can be provided. However, that is not necessarily true.

In the following situation:

- Only link protection is desired.
- Bandwidth protection is desired only for sub-pool traffic.

For each protected link AB with a maximum reservable subpool value of n , there may be a path from node A to node B such that the difference between the maximum reservable global and the maximum reservable subpool is at least the value of n . If it is possible to find such paths for each link in the network, you can establish all the backup tunnels along such paths without any bandwidth reservations. If there is a single link failure, only one backup tunnel will use any link on its path. Because that path has at least n available bandwidth (in the global pool), assuming that marking and scheduling is configured to classify the subpool traffic into a priority queue, the subpool bandwidth is guaranteed.

This approach allows sharing of the global pool bandwidth between backup tunnels protecting independent link failures. The backup tunnels are expected to be used for only a short period of time after a failure (until the headends of affected LSPs reroute those LSPs to other paths with available subpool bandwidth). The probability of multiple unrelated link failures is very small (in the absence of node or shared risk link group (SRLG) failures, which result in multiple link failures). Therefore, it is reasonable to assume that link failures are in practice independent with high probability. This “independent failure assumption” in combination with backup tunnels signaled without explicit bandwidth reservation enables efficient bandwidth sharing that yields substantial bandwidth savings.

Backup tunnels protecting the subpool traffic do not draw bandwidth from any pool. Primary traffic using the global pool can use the entire global pool, and primary traffic using the subpool can use the entire subpool. Yet, subpool traffic has a complete bandwidth guarantee if there is a single link failure.

A similar approach can be used for node and SRLG protection. However, the decision of where to put the backup tunnels is more complicated because both node and SRLG failures effectively result in the simultaneous failure of several links. Therefore, the backup tunnels protecting traffic traversing all affected links cannot be computed independently of each other. The backup tunnels protecting groups of links corresponding to different failures can still be computed independently of each other, which results in similar bandwidth savings.

Signaled Bandwidth Versus Backup Bandwidth

Backup bandwidth is used locally (by the router that is the headend of the backup tunnel) to determine which, and how many, primary LSPs can be rerouted on a particular backup tunnel. The router ensures that the combined bandwidth requirement of these LSPs does not exceed the backup bandwidth.

Therefore, even when the backup tunnel is signaled with zero bandwidth, the backup bandwidth must be configured with the value corresponding to the actual bandwidth requirement of the traffic protected by this backup tunnel. Unlike the case when bandwidth requirements of the backup tunnels are explicitly signaled, the value of the signaled bandwidth (which is zero) is not the same value as the backup bandwidth.

How to Configure MPLS Traffic Engineering—Fast Reroute Link and Node Protection

This section assumes that you want to add FRR protection to a network in which MPLS TE LSPs are configured.

Enabling Fast Reroute on LSPs

LSPs can use backup tunnels only if they have been configured as fast reroutable. To do this, enter the following commands at the headend of each LSP.

SUMMARY STEPS

1. **enable**
2. **configure terminal**
3. **interface tunnel *number***
4. **tunnel mpls traffic-eng fast-reroute [bw-protect]**

DETAILED STEPS

	Command or Action	Purpose
Step 1	enable Example: Router> enable	Enables privileged EXEC mode. <ul style="list-style-type: none"> • Enter your password if prompted.
Step 2	configure terminal Example: Router# configure terminal	Enters global configuration mode.
Step 3	interface tunnel <i>number</i> Example: Router(config)# interface tunnel 1000	Enters interface configuration mode for the specified tunnel.

	Command or Action	Purpose
Step 4	tunnel mpls traffic-eng fast-reroute [bw-protect] Example: <pre>Router(config-if)# tunnel mpls traffic-eng fast-reroute bw-protect</pre>	Enables an MPLS TE tunnel to use an established backup tunnel if there is a link or node failure.

Creating a Backup Tunnel to the Next Hop or to the Next-Next Hop

Creating a backup tunnel is basically no different from creating any other tunnel. To create a backup tunnel to the next hop or to the next-next hop, enter the following commands on the node that will be the headend of the backup tunnel (that is, the node whose downstream link or node may fail). The node on which you enter these commands must be a supported platform. See the Finding Feature Information section.

SUMMARY STEPS

1. **enable**
2. **configure terminal**
3. **interface tunnel** *number*
4. **ip unnumbered** *interface-type interface-number*
5. **tunnel destination** *ip-address*
6. **tunnel mode mpls traffic-eng**
7. **tunnel mpls traffic-eng path-option [protect] preference-number {dynamic | explicit} {name path-name | path-number} {lockdown}**
8. **ip explicit-path name** *word*
9. **exclude-address** *ip-address*

DETAILED STEPS

	Command or Action	Purpose
Step 1	enable Example: <pre>Router> enable</pre>	Enables privileged EXEC mode. <ul style="list-style-type: none"> • Enter your password if prompted.
Step 2	configure terminal Example: <pre>Router# configure terminal</pre>	Enters global configuration mode.

	Command or Action	Purpose
Step 3	interface tunnel <i>number</i> Example: <pre>Router(config)# interface tunnel 1</pre>	Creates a new tunnel interface and enters interface configuration mode.
Step 4	ip unnumbered <i>interface-type interface-number</i> Example: <pre>Router(config-if)# ip unnumbered loopback 0</pre>	Gives the tunnel interface an IP address that is the same as that of interface Loopback0. Note This command is not effective until Loopback0 has been configured with an IP address.
Step 5	tunnel destination <i>ip-address</i> Example: <pre>Router(config-if)# tunnel destination 10.3.3.3</pre>	Specifies the IP address of the device where the tunnel will terminate. This address should be the router ID of the device that is the NHOP or NNHOP of LSPs to be protected.
Step 6	tunnel mode mpls traffic-eng Example: <pre>Router(config-if)# tunnel mode mpls traffic-eng</pre>	Sets the encapsulation mode of the tunnel to MPLS TE.
Step 7	tunnel mpls traffic-eng path-option [protect] <i>preference-number</i> { dynamic explicit }{ name path-name <i>path-number</i> }[lockdown] Example: <pre>Router(config-if)# tunnel mpls traffic-eng path-option 10 explicit avoid-protected-link</pre>	Configures a path option for an MPLS TE tunnel. Enters router configuration mode.
Step 8	ip explicit-path name <i>word</i> Example: <pre>Router(config-router)# ip explicit-path name avoid-protected-link</pre>	Enters the command mode for IP explicit paths and creates the specified path. Enters explicit path command mode.
Step 9	exclude-address <i>ip-address</i> Example:	For link protection, specify the IP address of the link to be protected. For node protection, specify the router ID of the node to be protected. Note Backup tunnel paths can be dynamic or explicit and they do not have to use exclude-address. Because backup tunnels must avoid the protected link or node, it is convenient to use the exclude-address command.

	Command or Action	Purpose
	<p>Example:</p> <p>Example:</p> <p>Example:</p> <p>Example:</p> <p>Example:</p> <pre>Router(config-ip-expl-path)# exclude-address 3.3.3.3</pre>	<p>Note When using the exclude-address command to specify the path for a backup tunnel, you must exclude an interface IP address to avoid a link (for creating an NHOP backup tunnel), or a router ID address to avoid a node (for creating an NNNHOP backup tunnel).</p>

Assigning Backup Tunnels to a Protected Interface

To assign one or more backup tunnels to a protected interface, enter the following commands on the node that will be the headend of the backup tunnel (that is, the node whose downstream link or node may fail). The node on which you enter these commands must be a supported platform. See the Finding Feature Information section.



Note

You must configure the interface to have an IP address and to enable the MPLS TE tunnel feature.

SUMMARY STEPS

1. **enable**
2. **configure terminal**
3. **interface** *type slot / port*
4. **mpls traffic-eng backup-path tunnel** *interface*

DETAILED STEPS

	Command or Action	Purpose
Step 1	enable	Enables privileged EXEC mode.

	Command or Action	Purpose
	<p>Example:</p> <pre>Router> enable</pre>	<ul style="list-style-type: none"> • Enter your password if prompted.
Step 2	<p>configure terminal</p> <p>Example:</p> <pre>Router# configure terminal</pre>	Enters global configuration mode.
Step 3	<p>interface <i>type slot / port</i></p> <p>Example:</p> <p>Example:</p> <p>Example:</p> <p>Example:</p> <p>Example:</p> <pre>Router(config)# interface POS 5/0</pre>	Moves configuration to the physical interface level, directing subsequent configuration commands to the specific physical interface identified by the <i>type</i> value. The <i>slot</i> and <i>port</i> identify the slot and port being configured. The interface must be a supported interface. See the Finding Feature Information section. Enters interface configuration mode.
Step 4	<p>mpls traffic-eng backup-path tunnel <i>interface</i></p> <p>Example:</p> <pre>Router(config-if)# mpls traffic-eng backup-path tunnel 2</pre>	<p>Allows LSPs going out this interface to use this backup tunnel if there is a link or node failure.</p> <p>Note You can enter this command multiple times to associate multiple backup tunnels with the same protected interface.</p>

Associating Backup Bandwidth and Pool Type with a Backup Tunnel

To associate backup bandwidth with a backup tunnel and designate the type of LSP that can use a backup tunnel, enter the following commands.

SUMMARY STEPS

1. **enable**
2. **configure terminal**
3. **interface tunnel** *number*
4. **tunnel mpls traffic-eng backup-bw** *{bandwidth | [sub-pool {bandwidth | Unlimited}] [global-pool {bandwidth | Unlimited}]*

DETAILED STEPS

	Command or Action	Purpose
Step 1	enable Example: Router> enable	Enables privileged EXEC mode. <ul style="list-style-type: none"> • Enter your password if prompted.
Step 2	configure terminal Example: Router# configure terminal	Enters global configuration mode.
Step 3	interface tunnel <i>number</i> Example: Router(config)# interface tunnel 2	Enters interface configuration mode for the specified tunnel.
Step 4	tunnel mpls traffic-eng backup-bw <i>{bandwidth [sub-pool {bandwidth Unlimited}] [global-pool {bandwidth Unlimited}]</i> Example: Router(config-if)# tunnel mpls traffic-eng backup-bw sub-pool 1000	Associates bandwidth with a backup tunnel and designates whether LSPs that allocate bandwidth from the specified pool can use the tunnel.

Configuring Backup Bandwidth Protection

SUMMARY STEPS

1. enable
2. configure terminal
3. tunnel mpls traffic-eng fast-reroute [bw-protect]
4. mpls traffic-eng fast-reroute backup-prot-preemption [optimize-bw]

DETAILED STEPS

	Command or Action	Purpose
Step 1	<p>enable</p> <p>Example:</p> <pre>Router> enable</pre>	<p>Enables privileged EXEC mode.</p> <ul style="list-style-type: none"> • Enter your password if prompted.
Step 2	<p>configure terminal</p> <p>Example:</p> <pre>Router# configure terminal</pre>	<p>Enters interface configuration mode.</p>
Step 3	<p>tunnel mpls traffic-eng fast-reroute [bw-protect]</p> <p>Example:</p> <pre>Router(config-if)# tunnel mpls traffic-eng fast-reroute bw-protect</pre>	<p>Enables an MPLS TE tunnel to use an established backup tunnel in the event of a link or node failure.</p> <ul style="list-style-type: none"> • The bw-protect keyword gives an LSP priority for using backup tunnels with bandwidth protection. Enters global configuration mode.
Step 4	<p>mpls traffic-eng fast-reroute backup-prot-preemption [optimize-bw]</p> <p>Example:</p> <pre>Router(config)# mpls traffic-eng fast-reroute backup-prot-preemption optimize-bw</pre>	<p>Changes the backup protection preemption algorithm from minimize the number of LSPs that are demoted to minimize the amount of bandwidth that is wasted.</p>

Configuring an Interface for Fast Link and Node Failure Detection

SUMMARY STEPS

1. **enable**
2. **configure terminal**
3. **interface** *type slot / port*
4. **pos ais-shut**
5. **pos report** {**b1-tca** | **b2-tca** | **b3-tca** | **lais** | **lrldi** | **pais** | **plop** | **prdi** | **rdool** | **sd-ber** | **sf-ber** | **slof** | **slos**}

DETAILED STEPS

	Command or Action	Purpose
Step 1	enable Example: Router> enable	Enables privileged EXEC mode. <ul style="list-style-type: none"> • Enter your password if prompted.
Step 2	configure terminal Example: Router# configure terminal	Enters global configuration mode.
Step 3	interface <i>type slot / port</i> Example: Router(config)# interface pos0/0	Configures an interface type and enters interface configuration mode.
Step 4	pos ais-shut Example: Router(config-if)# pos ais-shut	Sends the line alarm indication signal (LAIS) when the POS interface is placed in any administrative shutdown state.
Step 5	pos report { b1-tca b2-tca b3-tca lais lrldi pais plop prdi rdool sd-ber sf-ber slof slos } Example: Router(config-if)# pos report lrldi	Permits selected SONET alarms to be logged to the console for a POS interface.

Verifying That Fast Reroute Is Operational

To verify that FRR can function, perform the following task.

SUMMARY STEPS

1. **show mpls traffic-eng tunnels brief**
2. **show ip rsvp sender detail**
3. **show mpls traffic-eng fast-reroute database**
4. **show mpls traffic-eng tunnels backup**
5. **show mpls traffic-eng fast-reroute database**
6. **show ip rsvp reservation**

DETAILED STEPS

Step 1 **show mpls traffic-eng tunnels brief**

Use this command to verify that backup tunnels are up:

Example:

```
Router# show mpls traffic-eng tunnels brief

Signalling Summary:
  LSP Tunnels Process:      running
  RSVP Process:            running
  Forwarding:              enabled
  Periodic reoptimization: every 3600 seconds, next in 1706 seconds
TUNNEL NAME                DESTINATION    UP IF    DOWN IF    STATE/PROT
Router_t1                   10.112.0.12   -        PO2/0/1   up/up
Router_t2                   10.112.0.12   -        unknown   up/down
Router_t3                   10.112.0.12   -        unknown   admin-down
Router_t1000                10.110.0.10   -        unknown   up/down
Router_t2000                10.110.0.10   -        PO2/0/1   up/up
Displayed 5 (of 5) heads, 0 (of 0) midpoints, 0 (of 0) tails
```

Step 2 **show ip rsvp sender detail**

Use this command to verify that LSPs are protected by the appropriate backup tunnels.

Following is sample output from the **show ip rsvp sender detail** command when the command is entered at the PLR before a failure:

Example:

```
Router# show ip rsvp sender detail

PATH:
Tun Dest:  10.10.0.6  Tun ID: 100  Ext Tun ID: 10.10.0.1
Tun Sender: 10.10.0.1  LSP ID: 31
Path refreshes:
  arriving: from PHOP 10.10.7.1 on FE0/0/0 every 30000 msecs
Session Attr:
  Setup Prio: 7, Holding Prio: 7
  Flags: (0x7) Local Prot desired, Label Recording, SE Style
  session Name: R1_t100
ERO: (incoming)
```

```

10.10.7.2 (Strict IPv4 Prefix, 8 bytes, /32)
10.10.0.6 (Strict IPv4 Prefix, 8 bytes, /32)
RRO:
 10.10.7.1/32, Flags:0x0 (No Local Protection)
 10.10.4.1/32, Flags:0x9 (Local Prot Avail/to NNHOP) !Available to NNHOP
 10.10.1.1/32, Flags:0x0 (No Local Protection)
Traffic params - Rate: 10K bits/sec, Max. burst: 1K bytes
Min Policed Unit: 0 bytes, Max Pkt Size 4294967295 bytes
Fast-Reroute Backup info:
  Inbound FRR: Not active
  Outbound FRR: No backup tunnel selected
Path ID handle: 50000416.
Incoming policy: Accepted. Policy source(s): MPLS/TE
Status: Proxy-terminated

```

Step 3 **show mpls traffic-eng fast-reroute database**

Enter the **clear ip rsvp hello instance counters** command to verify the following:

- MPLS TE FRR Node Protection has been enabled.
- A certain type of LSP can use a backup tunnel.

The following command output displays the LSPs that are protected:

Example:

```

Router# show mpls traffic-eng fast-reroute database
Tunnel head end item frr information:
Protected tunnel      In-label Out intf/label      FRR intf/label      Status
Tunnel500            Tun hd   AT2/0/0.100:Untagg Tu501:20             ready
Prefix item frr information:
Prefix               Tunnel   In-label Out intf/label      FRR intf/label      Status
10.0.0.8/32         Tu500   18      AT2/0/0.100:Pop ta Tu501:20             ready
10.0.8.8/32         Tu500   19      AT2/0/0.100:Untagg Tu501:20             ready
10.8.9.0/24         Tu500   22      AT2/0/0.100:Untagg Tu501:20             ready
LSP midpoint item frr information:
LSP identifier       In-label Out intf/label      FRR intf/label      Status

```

If LDP is not enabled, separate prefix items are not shown because all prefixes then use a single rewrite. To confirm that a particular IP prefix is FRR protected, even though it is not shown in this display, enter it within the **show mpls forwarding-table ip-address detail** command. The final line of the display will tell whether that prefix is protected:

Example:

```

Router# show mpls forwarding-table 10.0.0.11 32 detail

Local   Outgoing   Prefix           Bytes tag   Outgoing   Next Hop
tag     tag or VC  or Tunnel Id    switched   interface
Tun hd  Untagged  10.0.0.11/32    48         pos1/0/0   point2point
MAC/Encaps=4/8, MTU=1520, Tag Stack{22}
48D18847 00016000
No output feature configured
Fast Reroute Protection via (Tu0, outgoing label 12304)

```

The following command output displays the LSPs that are protected when the FRR *primary* tunnel is over an ATM interface and the backup tunnel is over a POS interface. As shown in the figure below, interface ATM2/0/0.100 is protected by backup tunnel 501.

Figure 7: Protected LSPs

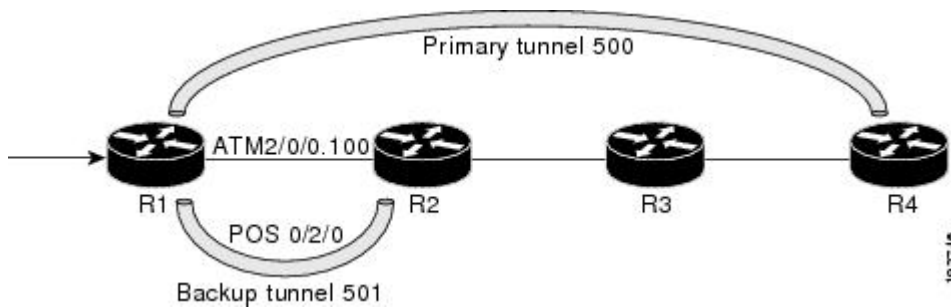

This figure displays the protected LSPs:

- The primary tunnel is 500 and the path is R1 via ATM2/0/0.100 to R2, from R2 to R3, and from R3 to R4.
- The FRR backup tunnel is 501 and the path is R1 via POS0/2/0 to R2.
- The interface ATM2/0/0.100 is protected by the backup tunnel 501.

Example:

```
Router# show mpls traffic-eng fast-reroute database
Tunnel head end item frr information:
Protected tunnel In-label Out intf/label FRR intf/label Status
Tunnel500 Tun hd AT2/0/0.100:Untagg Tu501:20 ready
Prefix item frr information:
Prefix Tunnel In-label Out intf/label FRR intf/label Status
10.0.0.8/32 Tu500 18 AT2/0/0.100:Pop ta Tu501:20 ready
10.0.8.8/32 Tu500 19 AT2/0/0.100:Untagg Tu501:20 ready
10.8.9.0/24 Tu500 22 AT2/0/0.100:Untagg Tu501:20 ready
LSP midpoint item frr information:
LSP identifier In-label Out intf/label FRR intf/label Status
```

The following command output displays the LSPs that are protected when the FRR *backup* tunnel is over an ATM interface:

Example:

```
Router# show mpls traffic-eng fast-reroute database
Tunnel head end item frr information:
Protected tunnel In-label Out intf/label FRR intf/label Status
Tunnel500 Tun hd PO0/2/0:Untagged Tu501:20 ready
Prefix item frr information:
Prefix Tunnel In-label Out intf/label FRR intf/label Status
10.0.0.8/32 Tu500 18 PO0/2/0:Pop tag Tu501:20 ready
10.0.8.8/32 Tu500 19 PO0/2/0:Untagged Tu501:20 ready
10.8.9.0/24 Tu500 22 PO0/2/0:Untagged Tu501:20 ready
LSP midpoint item frr information:
LSP identifier In-label Out intf/label FRR intf/label Status
```

Step 4 show mpls traffic-eng tunnels backup

The following conditions must exist for backup tunnels to be operational:

- **LSP is reroutable**--At the headend of the LSP, enter the **show run int tunnel tunnel-number** command. The output should include the **tunnel mpls traffic-eng fast-reroute** command. If it does not, enter this command for the tunnel.

On the router where the backup tunnels originate, enter the **show mpls traffic-eng tunnels backup** command. Following is sample command output:

Example:

```
Router# show mpls traffic-eng tunnels backup
Router_t578
LSP Head, Tunnel578, Admin: up, Oper: up
Src 10.55.55.55, Dest 10.88.88.88, Instance 1
Fast Reroute Backup Provided:
  Protected i/fs: PO1/0/0, PO1/1/0, PO0/3/3
  Protected lsp: 1
  Backup BW: any pool unlimited; inuse: 100 kbps
Router_t5710
LSP Head, Tunnel5710, Admin: admin-down, Oper: down
Src 10.55.55.55, Dest 10.7.7.7, Instance 0
Fast Reroute Backup Provided:
  Protected i/fs: PO1/1/0
  Protected lsp: 0
  Backup BW: any pool unlimited; inuse: 0 kbps
Router_t5711
LSP Head, Tunnel5711, Admin: up, Oper: up
Src 10.55.55.55, Dest 10.7.7.7, Instance 1
Fast Reroute Backup Provided:
  Protected i/fs: PO1/0/0
  Protected lsp: 2
  Backup BW: any pool unlimited; inuse: 6010 kbps
```

The command output will allow you to verify the following:

- Backup tunnel exists--Verify that there is a backup tunnel that terminates at this LSP's NHOP or NNHOP. Look for the LSP's NHOP or NNHOP in the Dest field.
- Backup tunnel is up--To verify that the backup tunnel is up, look for "Up" in the State field.
- Backup tunnel is associated with LSP's I/F--Verify that the interface for the LSP is allowed to use this backup tunnel. Look for the LSP's output interface in the "protects" field list.
- Backup tunnel has sufficient bandwidth--If you restricted the amount of bandwidth a backup tunnel can hold, verify that the backup tunnel has sufficient bandwidth to hold the LSPs that would use this backup tunnel if there is a failure. The bandwidth of an LSP is defined by the line **tunnel mpls traffic-eng bandwidth** at the headend of the LSP. To determine the available bandwidth on a backup tunnel, look at the "cfg" and "inuse" fields. If there is insufficient backup bandwidth to accommodate the LSPs that would use this backup tunnel in the event of a failure, create an additional backup tunnel or increase the backup bandwidth of the existing tunnel by using the **tunnel mpls traffic-eng bandwidth** command.

Note To determine how much bandwidth is sufficient, offline capacity planning may be required.

- Backup tunnel has appropriate bandwidth type--If you restricted the type of LSPs (subpool or global pool) that can use this backup tunnel, verify that the LSP is the appropriate type for the backup tunnel. The type of the LSP is defined by the line **tunnel mpls traffic-eng bandwidth** at the headend of this LSP. If this line contains the word "subpool", then it uses subpool bandwidth; otherwise, it uses global pool bandwidth. Verify that the type matches the type the backup tunnel can hold by looking in the output of the above command.

If none of the above actions works, enable debug by entering the **debug ip rsvp fast-reroute** command and the **debug mpls traffic-eng fast-reroute** command on the router that is the headend of the backup tunnel. Then do the following:

- 1 Enter the **shutdown** command for the primary tunnel.
- 2 Enter the **no shutdown** command for the primary tunnel.
- 3 View the debug output.

Step 5 **show mpls traffic-eng fast-reroute database**

Enter the **clear ip rsvp hello instance counters** command to verify the following:

- MPLS TE FRR Node Protection has been enabled.
- A certain type of LSP can use a backup tunnel.

The following command output displays the LSPs that are protected:

Example:

```
Router# show mpls traffic-eng fast-reroute database
Tunnel head end item frr information:
Protected Tunnel  In-label  intf/label          FRR intf/label      Status
Tunnell0         Tun       pos1/0/0:Untagged  Tu0:12304           ready
Prefix item frr information:
Prefix           Tunnel  In-label  Out intf/label      FRR intf/label      Status
10.0.0.11/32     Tu110   Tun hd    pos1/0/0:Untagged  Tu0:12304           ready
LSP midpoint frr information:
LSP identifier   In-label  Out intf/label      FRR intf/label      Status
10.0.0.12 1 [459]  16        pos0/1/0:17        Tu2000:19           ready
```

Note If LDP is not enabled, separate prefix items are not shown because all prefixes then use a single rewrite. To confirm that a particular IP prefix is FRR protected, even though it is not shown in this display, enter it within the **show mpls forwarding-table ip-address detail** command. The final line of the display will tell whether that prefix is protected:

Example:

```
Router# show mpls forwarding-table 10.0.0.11 32 detail

Local   Outgoing  Prefix           Bytes tag   Outgoing     Next Hop
tag     tag or VC or Tunnel Id  switched    interface
Tun hd  Untagged  10.0.0.11/32     48          pos1/0/0     point2point
        MAC/Encaps=4/8, MTU=1520, Tag Stack{22}
        48D18847 00016000
        No output feature configured
        Fast Reroute Protection via (Tu0, outgoing label 12304)
```

Step 6 **show ip rsvp reservation**

Following is sample output from the **show ip rsvp reservation** command entered at the headend of a primary LSP. Entering the command at the head-end of the primary LSP shows, among other things, the status of FRR (that is, local protection) at each hop this LSP traverses. The per-hop information is collected in the Record Route Object (RRO) that travels with the Resv message from the tail to the head.

Example:

```
Router# show ip rsvp reservation detail
Reservation:
```

```

Tun Dest: 10.1.1.1 Tun ID: 1 Ext Tun ID: 10.1.1.1
Tun Sender: 10.1.1.1 LSP ID: 104
Next Hop: 10.1.1.2 on POS1/0/0
Label: 18 (outgoing)
Reservation Style is Shared-Explicit, QoS Service is Controlled-Load
Average Bitrate is 0 bits/sec, Maximum Burst is 1K bytes
Min Policed Unit: 0 bytes, Max Pkt Size: 0 bytes
RRO:
  10.1.1.1/32, Flags:0x1 (Local Prot Avail/to NHOP)
    Label subobject: Flags 0x1, C-Type 1, Label 18
  10.1.1.1/32, Flags:0x0 (Local Prot Avail/In Use/Has BW/to NHOP)
    Label subobject: Flags 0x1, C-Type 1, Label 16
  10.1.1.2/32, Flags:0x0 (No Local Protection)
    Label subobject: Flags 0x1, C-Type 1, Label 0
Resv ID handle: CD000404.
Policy: Accepted. Policy source(s): MPLS/TE

```

Notice the following about the primary LSP:

- It has protection that uses a NHOP backup tunnel at its first hop.
- It has protection and is actively using an NHOP backup tunnel at its second hop.
- It has no local protection at its third hop.

The RRO display shows the following information for each hop:

- Whether local protection is available (that is, whether the LSP has selected a backup tunnel)
- Whether local protection is in use (that is, whether the LSP is currently using its selected backup tunnel)
- Whether the selected backup tunnel is an NHOP or NNHOP backup tunnel
- Whether the backup tunnel used at this hop provides bandwidth protection

Troubleshooting Tips

This section describes the following:

LSPs Do Not Become Active; They Remain Ready

At a PLR, LSPs transition from Ready to Active if one of the following events occurs:

- Primary interface goes down--If the primary interface (LSP's outbound interface) goes down and the LSP is ready to use a backup tunnel, the LSP will transition to the active state causing its data to flow over the backup tunnel. On some platforms and interface types (for example, GSR POS interfaces), there is fast interface-down logic that detects this event very quickly. On other platforms where this logic does not exist, detection time is slower. On such platforms, it may be desirable to enable RSVP Hello (see the next bulleted item, "Hellos detect next hop is down").
- Hellos detect next hop is down--If Hellos are enabled on the primary interface (LSP's outbound interface), and the LSP's next hop is no longer reachable, the next hop is declared down. This event will cause the LSP to begin actively using its backup tunnel. Notice that a next hop will be declared down even if the primary interface does not go down. For example, if the next hop stops responding due to a reboot or software or hardware problem, Hellos will trigger the LSPs using this next hop to switch to their backup

tunnels. Hellos can also help trigger FRR on interfaces such as Gigabit Ethernet where the interface remains up but is unusable (due to lack of link-layer liveness detection mechanisms).

Primary Tunnel Does Not Select Backup Tunnel That Is Up

If a backup tunnel is up, but it is not selected as a backup tunnel by the primary tunnel (LSP), enter the following commands for the backup tunnel:

- **shutdown**
- **no shutdown**



Note

If you change the status of a backup tunnel, the backup tunnel selection algorithm is rerun for the backup tunnel. LSPs that have currently selected (that is, are ready to use) that backup tunnel will be disassociated from it, and then reassociated with that backup tunnel or another backup tunnel. This is generally harmless and usually results in mapping the same LSPs to that backup tunnel. However, if any LSPs are actively using that backup tunnel, shutting down the backup tunnel will tear down those LSPs.

Enhanced RSVP Commands Display Useful Information

The following RSVP commands have been enhanced to display information that can be helpful when you are examining the FRR state or troubleshooting FRR:

- **show ip rsvp request** --Displays upstream reservation state (that is, information related to the Resv messages that this node will send upstream).
- **show ip rsvp reservation** --Displays information about Resv messages received.
- **show ip rsvp sender** --Displays information about path messages being received.

These commands show control plane state; they do not show data state. That is, they show information about RSVP messages (Path and Resv) used to signal LSPs. For information about the data packets being forwarded along LSPs, use the **show mpls forwarding** command.

RSVP Hello Detects When a Neighboring Node Is Not Reachable

The RSVP Hello feature enables RSVP nodes to detect when a neighboring node is not reachable. Use this feature when notification of link-layer failures is not available and unnumbered links are not used, or when the failure detection mechanisms provided by the link layer are not sufficient for timely node failure detection. Hello must be configured both globally on the router and on the specific interface to be operational.

Hello Instances Have Not Been Created

If Hello instances have not been created, do the following:

- Determine if RSVP Hello has been enabled globally on the router. Enter the **ip rsvp signalling hello(configuration)** command.
- Determine if RSVP Hello has been enabled on an interface that the LSPs traverse. Enter the **ip rsvp signalling hello(interface)** command.
- Verify that at least one LSP has a backup tunnel by displaying the output of the **show ip rsvp sender** command. A value of “Ready” indicates that a backup tunnel has been selected.

“No entry at index” (error may self-correct, RRO may not yet have propagated from downstream node of interest) Error Message Is Printed at the Point of Local Repair

FRR relies on a RRO in Resv messages arriving from downstream. Routers receiving path messages with the SESSION_ATTRIBUTE bit indicating that the LSP is fast-reroutable should include an RRO in the corresponding Resv messages.

If an LSP is configured for FRR, but the Resv arriving from a downstream router contains an incomplete RRO, the “No entry at index (error may self-correct, RRO may not yet have propagated from downstream node of interest)” message is printed. An incomplete RRO is one in which the NHOP or the NNHOP did not include an entry in the RRO.

This error typically means that backup tunnels to the NHOP or the NNHOP cannot be selected for this LSP because there is insufficient information about the NHOP or NNHOP due to the lack of an RRO entry.

Occasionally there are valid circumstances in which this situation occurs temporarily and the problem is self-corrected. If subsequent Resv messages arrive with a complete RRO, ignore the error message.

To determine whether the error has been corrected, display the RRO in Resv messages by entering the **clear ip rsvp hello instance counters** command. Use an output filter keyword to display only the LSP of interest.

“Couldn’t get rsbs” (error may self-correct when Resv arrives) Error Message Is Printed at the Point of Local Repair

The PLR cannot select a backup tunnel for an LSP until a Resv message has arrived from downstream.

When this error occurs, it typically means that something is wrong. For example, no reservation exists for this LSP. You can troubleshoot this problem by using the **debug ip rsvp reservation** command to enable debug.

Occasionally there are valid circumstances in which this error message occurs and there is no need for concern. One such circumstance is when an LSP experiences a change before any Resv message has arrived from downstream. Changes can cause a PLR to try to select a backup tunnel for an LSP, and the selection will fail (causing this error message) if no Resv message has arrived for this LSP.

Configuration Examples for MPLS Traffic Engineering—Fast Reroute Link and Node Protection

The examples relate to the illustration shown in the figure below.

Figure 8: Backup Tunnels

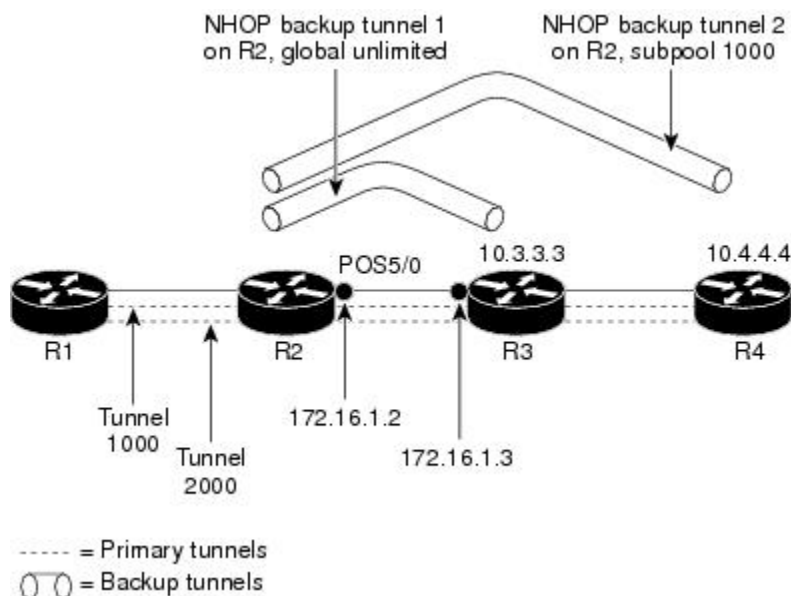

93901

Enabling Fast Reroute for all Tunnels Example

On router R1, enter interface configuration mode for each tunnel to be protected (Tunnel 1000 and Tunnel 2000). Enable these tunnels to use a backup tunnel in case of a link or node failure along their paths.

Tunnel 1000 will use 10 units of bandwidth from the subpool.

Tunnel 2000 will use five units of bandwidth from the global pool. The “bandwidth protection desired” bit has been set by specifying **bw-prot** in the **tunnel mpls traffic-eng fast-reroute** command.

```
Router(config)# interface Tunnel 1000
Router(config-if)# tunnel mpls traffic-eng fast-reroute
Router(config-if)# tunnel mpls traffic-eng bandwidth sub-pool 10
Router(config)# interface Tunnel2000
Router(config-if)# tunnel mpls traffic-eng fast-reroute bw-prot
Router(config-if)# tunnel mpls traffic-eng bandwidth 5
```

Creating an NHOP Backup Tunnel Example

On router R2, create an NHOP backup tunnel to R3. This backup tunnel should avoid using the link 172.1.1.2.

```
Router(config)# ip explicit-path name avoid-protected-link
Router(cfg-ip-expl-path)# exclude-address 172.1.1.2
```

```

Explicit Path name avoid-protected-link:
__1: exclude-address 172.1.1.2
Router(cfg-ip_expl-path)# end
Router(config)# interface Tunnel 1
Router(config-if)# ip unnumbered loopback0
Router(config-if)# tunnel destination 10.3.3.3
Router(config-if)# tunnel mode mpls traffic-eng
Router(config-if)# tunnel mpls traffic-eng path-option 10 explicit avoid-protected-link

```

Creating an NNHOP Backup Tunnel Example

On router R2, create an NNHOP backup tunnel to R4. This backup tunnel should avoid R3.

```

Router(config)# ip explicit-path name avoid-protected-node

Router(cfg-ip-expl-path)# exclude-address 10.3.3.3
Explicit Path name avoid-protected-node:
__1: exclude-address 10.3.3.3
Router(cfg-ip_expl-path)# end

Router(config)# interface Tunnel 2

Router(config-if)# ip unnumbered loopback0

Router(config-if)# tunnel destination 10.4.4.4

Router(config-if)# tunnel mode mpls traffic-eng

Router(config-if)# tunnel mpls traffic-eng path-option 10 explicit avoid-protected-node

```

Assigning Backup Tunnels to a Protected Interface Example

On router R2, associate both backup tunnels with interface POS 5/0:

```

Router(config)# interface POS 5/0

Router(config-if)# mpls traffic-eng backup-path tunnel 1

Router(config-if)# mpls traffic-eng backup-path tunnel 2

```

Associating Backup Bandwidth and Pool Type with Backup Tunnels Example

Backup tunnel 1 is to be used only by LSPs that take their bandwidth from the global pool. It does not provide bandwidth protection. Backup tunnel 2 is to be used only by LSPs that take their bandwidth from the subpool. Backup tunnel 2 provides bandwidth protection for up to 1000 units.

```

Router(config)# interface Tunnel 1

Router(config-if)# tunnel mpls traffic-eng backup-bw global-pool Unlimited
Router(config)# interface Tunnel 2

Router(config-if)# tunnel mpls traffic-eng backup-bw sub-pool 1000

```

Configuring Backup Bandwidth Protection Example

In the following example, backup bandwidth protection is configured:



Note

This global configuration is required only to change the backup protection preemption algorithm from minimize the number of LSPs that are demoted to minimize the amount of bandwidth that is wasted.

```
Router(config-if) # tunnel mpls traffic-eng fast-reroute bw-protect
Router(config) # mpls traffic-eng fast-reroute backup-prot-preemption optimize-bw
```

Configuring an Interface for Fast Link and Node Failure Detection Example

In the following example, pos ais-shut is configured:

```
Router(config) # interface pos 0/0
Router(config-if) # pos ais-shut
```

In the following example, report lrdi is configured on OS interfaces:

```
Router(config) # interface pos 0/0
Router(config-if) # pos report lrdi
```

Configuring RSVP Hello and POS Signals Example

Hello must be configured both globally on the router and on the specific interface on which you need FRR protection. To configure Hello, use the following configuration commands:

- **ip rsvp signalling hello** (configuration)--Enables Hello globally on the router.
- **ip rsvp signalling hello** (interface)--Enables Hello on an interface where you need FRR protection.

The following configuration commands are optional:

- **ip rsvp signalling hello dscp** --Sets the differentiated services code point (DSCP) value that is in the IP header of the Hello message.
- **ip rsvp signalling hello refresh misses** --Specifies how many acknowledgments a node can miss in a row before the node considers that communication with its neighbor is down.
- **ip rsvp signalling hello refresh interval** --Configures the Hello request interval.
- **ip rsvp signalling hello statistics** --Enables Hello statistics on the router.

For configuration examples, see the Hello command descriptions in the “Command Reference” section of *MPLS Traffic Engineering (TE): Link and Node Protection, with RSVP Hellos Support*, Release 12.0(24)S.

To configure POS signaling for detecting FRR failures, enter the **pos report all** command or enter the following commands to request individual reports:

```
pos ais-shut
```

```

pos report rdool
pos report lais
pos report lrldi
pos report pais
pos report prdi
pos report sd-ber

```

Additional References

Related Documents

Related Topic	Document Title
IS-IS	<i>Cisco IOS IP Routing Protocols Command Reference</i> Configuring a Basic IS-IS Network
Link protection	MPLS TE: Link and Node Protection, with RSVP Hellos Support (with Fast Tunnel Interface Down Detection)
Shared risk link groups	MPLS Traffic Engineering: Shared Risk Link Groups MPLS Traffic Engineering: Inter-AS TE
FRR protection of TE LSPs from SRLG failure	MPLS Traffic Engineering: Shared Risk Link Groups
MPLS traffic engineering commands	<i>Cisco IOS Multiprotocol Label Switching Command Reference</i>
Configuration of MPLS TE tunnels	MPLS Traffic Engineering: Interarea Tunnels
OSPF	<i>Cisco IOS IP Routing Protocols Command Reference</i> Configuring OSPF
RSVP	<i>Cisco IOS Quality of Service Solutions Command Reference</i>

Standards

Standards	Title
draft-ietf-mpls-rsvp-lsp-fastreroute-04.txt	Fast ReRoute Extensions to RSVP-TE for LSP Tunnels

MIBs

MIBs	MIBs Link
No new or modified MIBs are supported by this feature, and support for existing MIBs has not been modified by this feature.	To locate and download MIBs for selected platforms, Cisco IOS releases, and feature sets, use Cisco MIB Locator found at the following URL: http://www.cisco.com/go/mibs

RFCs

RFCs	Title
draft-ietf-mpls-rsvp-lsp-fastreroute-06.txt	http://www3.tools.ietf.org/html/draft-ietf-mpls-rsvp-lsp-fastreroute-06 Fast Reroute Extensions to RSVP-TE for LSP Tunnels

Technical Assistance

Description	Link
<p>The Cisco Support website provides extensive online resources, including documentation and tools for troubleshooting and resolving technical issues with Cisco products and technologies.</p> <p>To receive security and technical information about your products, you can subscribe to various services, such as the Product Alert Tool (accessed from Field Notices), the Cisco Technical Services Newsletter, and Really Simple Syndication (RSS) Feeds.</p> <p>Access to most tools on the Cisco Support website requires a Cisco.com user ID and password.</p>	http://www.cisco.com/techsupport

Command Reference

The following commands are introduced or modified in the feature or features documented in this module. For information about these commands, see the *Cisco IOS Multiprotocol Label Switching Command Reference* at http://www.cisco.com/en/US/docs/ios/mps/command/reference/mp_book.html. For information about all Cisco IOS commands, use the Command Lookup Tool at <http://tools.cisco.com/Support/CLILookup> or the *Cisco IOS Master Command List, All Releases*, at http://www.cisco.com/en/US/docs/ios/mcl/allreleasemcl/all_book.html.

- **clear ip rsvp hello instance counters**
- **clear ip rsvp hello instance statistics**

- **clear ip rsvp hello statistics**
- **debug ip rsvp hello**
- **ip rsvp signalling hello (configuration)**
- **ip rsvp signalling hello (interface)**
- **ip rsvp signalling hello dscp**
- **ip rsvp signalling hello refresh interval**
- **ip rsvp signalling hello refresh misses**
- **ip rsvp signalling hello statistics**
- **mpls traffic-eng backup-path tunnel**
- **mpls traffic-eng fast-reroute backup-prot-preemption**
- **mpls traffic-eng fast-reroute timers**
- **show ip rsvp fast bw-protect**
- **show ip rsvp fast detail**
- **show ip rsvp hello**
- **show ip rsvp hello instance detail**
- **show ip rsvp hello instance summary**
- **show ip rsvp hello statistics**
- **show ip rsvp interface detail**
- **show ip rsvp request**
- **show ip rsvp reservation**
- **show ip rsvp sender**
- **show mpls traffic tunnel backup**
- **show mpls traffic-eng fast-reroute database**
- **show mpls traffic-eng tunnels**
- **show mpls traffic-eng tunnels summary**
- **tunnel mpls traffic-eng backup-bw**
- **tunnel mpls traffic-eng fast-reroute**

Feature Information for MPLS Traffic Engineering—Fast Reroute Link and Node Protection

The following table provides release information about the feature or features described in this module. This table lists only the software release that introduced support for a given feature in a given software release train. Unless noted otherwise, subsequent releases of that software release train also support that feature.

Use Cisco Feature Navigator to find information about platform support and Cisco software image support. To access Cisco Feature Navigator, go to www.cisco.com/go/cfn. An account on Cisco.com is not required.

Table 3: Feature Information for MPLS Traffic Engineering—Fast Reroute Link and Node Protection

Feature Name	Releases	Feature Information
MPLS Traffic Engineering--Fast Reroute Link and Node Protection	12.0(10)ST 12.0(16)ST 12.0(22)S 12.0(23)S 12.0(24)S 12.0(29)S 12.2(33)SRA 12.4(20)T Cisco IOS XE Release 2.3 15.4(1)S	<p>The MPLS Traffic Engineering--Fast Reroute Link and Node Protection feature supports link protection (backup tunnels that bypass only a single link of the label-switched path (LSP), node protection (backup tunnels that bypass next-hop nodes along LSPs), and the following FRR features: backup tunnel support, backup bandwidth protection, and RSVP Hellos.</p> <p>In 12.0(10)ST, the Fast Reroute Link Protection feature was introduced.</p> <p>In 12.0(16)ST, Link Protection for Cisco series 7200 and 7500 platforms was added.</p> <p>In 12.0(22)S, Fast Reroute enhancements were added.</p> <p>In 12.0(23)S, the show mpls traffic-eng fast-reroute database command was revised.</p> <p>In 12.0(24)S, support for the Cisco 10720 Internet router and the Cisco 12000 series router engine 3 was added.</p> <p>In 12.0(29)S, backup bandwidth protection was added.</p> <p>In 12.2(33)SRA, the commands were integrated into this release.</p> <p>This feature was integrated into Cisco IOS Release 12.4(20)T.</p> <p>This feature was integrated into Cisco IOS XE Release 2.3.</p> <p>In Cisco IOS Release 15.4(1) S, support was added for the Cisco 901S platform.</p>

Feature Name	Releases	Feature Information
		<p>The following commands were introduced or modified: clear ip rsvp hello instance counters, clear ip rsvp hello instance statistics, clear ip rsvp hello statistics, debug ip rsvp hello, ip rsvp signalling hello (configuration), ip rsvp signalling hello (interface), ip rsvp signalling hello dscp, ip rsvp signalling hello refresh interval, ip rsvp signalling hello refresh misses, ip rsvp signalling hello statistics, mpls traffic-eng backup-path tunnel, mpls traffic-eng fast-reroute backup-prot-preemption, mpls traffic-eng fast-reroute timers, show ip rsvp fast bw-protect, show ip rsvp fast detail, show ip rsvp hello, show ip rsvp hello instance detail, show ip rsvp hello instance summary, show ip rsvp hello statistics, show ip rsvp interface detail, show ip rsvp request, show ip rsvp reservation, show ip rsvp sender, show mpls traffic tunnel backup, show mpls traffic-eng fast-reroute database, show mpls traffic-eng tunnels, show mpls traffic-eng tunnels summary, tunnel mpls traffic-eng backup-bw, tunnel mpls traffic-eng fast-reroute.</p>
MPLS Traffic Engineering - FRR Scalability Enhancements	Cisco IOS XE Release 3.6	<p>A restriction was added to the document that states the FRR link protect mode failover time is independent of the number of prefixes pointing to the link.</p> <p>In Cisco IOS XE Release 3.6S, support was added for the Cisco ASR 903 Router.</p>

Glossary

backup bandwidth --The usage of NHOP and NNHOP backup tunnels to provide bandwidth protection for rerouted LSPs.

backup tunnel --An MPLS TE tunnel used to protect other (primary) tunnels' traffic when a link or node failure occurs.

bandwidth --The available traffic capacity of a link.

Cisco Express Forwarding --A means for accelerating the forwarding of packets within a router, by storing route lookup.

enterprise network --A large and diverse network connecting most major points in a company or other organization.

Fast Reroute --Procedures that enable temporary routing around a failed link or node while a new LSP is being established at the headend.

global pool --The total bandwidth allocated to an MPLS traffic engineering link or node.

headend --The router that originates and maintains a given LSP. This is the first router in the LSP's path.

hop --Passage of a data packet between two network nodes (for example, between two routers).

instance --A Hello instance implements the RSVP Hello extensions for a given router interface address and remote IP address. Active Hello instances periodically send Hello Request messages, expecting Hello ACK messages in response. If the expected ACK message is not received, the active Hello instance declares that the neighbor (remote IP address) is unreachable (that is, it is lost). This can cause LSPs crossing this neighbor to be fast rerouted.

interface --A network connection.

Intermediate System-to-Intermediate System --IS-IS. Link-state hierarchical routing protocol that calls for intermediate system (IS) routers to exchange routing information based on a single metric to determine network topology.

link --A point-to-point connection between adjacent nodes. There can be more than one link between adjacent nodes. A link is a network communications channel consisting of a circuit or transmission path and all related equipment between a sender and a receiver. Sometimes referred to as a line or a transmission link.

limited backup bandwidth --Backup tunnels that provide bandwidth protection.

load balancing --A configuration technique that shifts traffic to an alternative link if a certain threshold is exceeded on the primary link. Load balancing is similar to redundancy in that if an event causes traffic to shift directions, alternative equipment must be present in the configuration. In load balancing, the alternative equipment is not necessarily redundant equipment that operates only in the event of a failure.

LSP --label-switched path. A connection between two routers in which MPLS forwards the packets.

merge point --The backup tunnel's tail.

MPLS --Multiprotocol Label Switching. Packet-forwarding technology, used in the network core, that applies data link layer labels to tell switching nodes how to forward data, resulting in faster and more scalable forwarding than network layer routing normally can do.

MPLS global label allocation --There is one label space for all interfaces in the router. For example, label 100 coming in one interface is treated the same as label 100 coming in a different interface.

NHOP --next hop. The next downstream node along an LSP's path.

NHOP backup tunnel --next-hop backup tunnel. Backup tunnel terminating at the LSP's next hop beyond the point of failure, and originating at the hop immediately upstream of the point of failure. It bypasses a failed link, and is used to protect primary LSPs that were using this link before the failure.

NNHOP --next-next hop. The node after the next downstream node along an LSP's path.

NNHOP backup tunnel --next-next-hop backup tunnel. Backup tunnel terminating at the LSP's next-next hop beyond the point of failure, and originating at the hop immediately upstream of the point of failure. It bypasses a failed link or node, and is used to protect primary LSPs that were using this link or node before the failure.

node --Endpoint of a network connection or a junction common to two or more lines in a network. Nodes can be interconnected by links, and serve as control points in the network. Nodes can be processors, controllers, or workstations.

OSPF --Open Shortest Path First. A link-state hierarchical Interior Gateway Protocol routing algorithm, derived from the IS-IS protocol. OSPF features include least-cost routing, multipath routing, and load balancing.

primary LSP --The last LSP originally signaled over the protected interface before the failure. The primary LSP is the LSP before the failure.

primary tunnel --Tunnel whose LSP may be fast rerouted if there is a failure. Backup tunnels cannot be primary tunnels.

promotion --Conditions, such as a new backup tunnel comes up, cause a reevaluation of a backup tunnel that was chosen for an LSP. If the reevaluation is successful, it is called a promotion.

protected interface --An interface that has one or more backup tunnels associated with it.

redundancy --The duplication of devices, services, or connections so that, in the event of a failure, the redundant devices, services, or connections can perform the work of those that failed.

RSVP --Resource Reservation Protocol. A protocol used for signaling requests (setting up reservations) for Internet services by a customer before that customer is permitted to transmit data over that portion of the network.

scalability --An indicator showing how quickly some measure of resource usage increases as a network gets larger.

SRLG --shared risk link group. Sets of links that are likely to go down together.

state --Information that a router must maintain about each LSP. The information is used for rerouting tunnels.

sub-pool --The more restrictive bandwidth in an MPLS traffic engineering link or node. The subpool is a portion of the link or node's overall global pool bandwidth.

tailend --The router upon which an LSP is terminated. This is the last router in the LSP's path.

topology --The physical arrangement of network nodes and media within an enterprise networking structure.

tunnel --Secure communications path between two peers, such as two routers.

unlimited backup bandwidth --Backup tunnels that provide no bandwidth (best-effort) protection (that is, they provide best-effort protection).