

IMPORTANT SAFETY INSTRUCTIONS, continued

Accessories Warning

WARNING: Avoid electric shock and fire hazard! Only use attachments/accessories specified by your service provider or the manufacturer.

Service Warnings

WARNING: Avoid electric shock! Do not open the cover of this product. Opening or removing the cover may expose you to dangerous voltages. If you open the cover, your warranty will be void. This product contains no user-serviceable parts. Refer all servicing to qualified service personnel.

Servicing is required when the apparatus has been damaged in any way, such as a power-supply cord or plug is damaged, liquid has been spilled or objects have fallen into the apparatus, the apparatus has been exposed to rain or moisture, does not operate normally, or has been dropped.

Check Product Safety

Upon completion of any service or repairs to this product, the service technician must perform safety checks to determine that this product is in proper operating condition.

Protect the Product when Moving It

Always disconnect the power source when moving the apparatus or connecting or disconnecting cables.

WARNING: Avoid personal injury and damage to this product! Use only with the cart, stand, tripod, bracket, or table specified by the manufacturer or sold with the apparatus. When a cart is used, use caution when moving the cart/ apparatus combination to avoid injury from tip-over.

20070802 Set-Top Cable US & Canada

Software and Firmware Use

The software described in this document is protected by copyright law and furnished to you under a license agreement. You may only use or copy this software in accordance with the terms of your license agreement.

The firmware in this equipment is protected by copyright law. You may only use the firmware in the equipment in which it is provided. Any reproduction or distribution of this firmware, or any portion of it, without our express written consent is prohibited.

Disclaimer

Cisco Systems, Inc. assumes no responsibility for errors or omissions that may appear in this guide. Cisco reserves the right to change this guide at any time without notice.



Cisco Systems, Inc.
5030 Sugarloaf Parkway, Box 465447
Lawrenceville, GA 30042

Cisco and the Cisco logo are trademarks or registered trademarks of Cisco and/or its affiliates in the U.S. and other countries. To view a list of Cisco's trademarks, go to this URL: www.cisco.com/go/trademarks.

Rovi is a trademark of Rovi Corporation.

Other third party trademarks mentioned are the property of their respective owners.

The use of the word partner does not imply a partnership relationship between Cisco and any other company. (1110R)

©2005, 2007, 2010-2012 Cisco and/or its affiliates. All rights reserved.

October 2012

Printed in United States of America

FCC Compliance

United States FCC Compliance

This device has been tested and found to comply with the limits for a Class B digital device, pursuant to part 15 of the FCC Rules. These limits are designed to provide reasonable protection against such interference in a residential installation. This equipment generates, uses, and can radiate radio frequency energy. If not installed and used in accordance with the instructions, it may cause harmful interference to radio communications. However, there is no guarantee that interference will not occur in a particular installation. If this equipment does cause harmful interference to radio or television reception, which can be determined by turning the equipment OFF and ON, the user is encouraged to try to correct the interference by one or more of the following measures:

- Reorient or relocate the receiving antenna.
- Increase the separation between the equipment and receiver.
- Connect the equipment into an outlet on a circuit different from that to which the receiver is connected.
- Consult the cable company or an experienced radio/television technician for help.
- Any changes or modifications not expressly approved by Cisco Systems, Inc., could void the user's authority to operate the equipment.

The information shown in the FCC Declaration of Conformity paragraph below is a requirement of the FCC and is intended to supply you with information regarding the FCC approval of this device. *The phone numbers listed are for FCC-related questions only and not intended for questions regarding the connection or operation for this device. Please contact your cable service provider for any questions you may have regarding the operation or installation of this device.*

FCC Declaration of Conformity

This device complies with Part 15 of FCC Rules. Operation is subject to the following two conditions: 1) the device may not cause harmful interference, and 2) the device must accept any interference received, including interference that may cause undesired operation.

Explorer 4250 Home Gateway
Model: Explorer 4250
Cisco Systems, Inc.
5030 Sugarloaf Parkway
Lawrenceville, Georgia 30044 USA
Telephone: **678 277-1120**

Canada EMI Regulation

This Class B digital apparatus complies with Canadian ICES-003.

Cet appareil numérique de la class B est conforme à la norme NMB-003 du Canada.

20081121 FCC STD

ROVI CORPORATION COPYRIGHT NOTICE

This product incorporates copyright protection technology that is protected by U.S. patents and other intellectual property rights of Rovi Corporation. Use of this copyright protection technology must be authorized by Rovi Corporation, and is intended for home and other limited viewing uses only unless otherwise authorized by Rovi Corporation. Reverse engineering and disassembly are prohibited.

678 277-1120
800 722-2009
www.cisco.com



Explorer 4250 Home Gateway

Safety First

Before using the Explorer® 4250™ Home Gateway, read the Important Safety Instructions section of this sheet. Follow the instructions to install the 4250, to become familiar with the buttons on the front panel, and to access your cable services. Then, enjoy the features of the 4250!

For more information about this product, visit our website: <http://www.cisco.com/web/consumer/support/index.html>

Explorer 4250 Home Gateway Serial Number

If the 4250 requires troubleshooting in the future, your cable service provider may ask for the serial number. The serial number is on the back panel; it begins with "SA" and is located in the lower left corner of the bar code. Use the space provided here to record the serial number:

Front Panel Features

- 1 POWER** Provides power to the 4250. A light in the LED display illuminates when the power is on
Note: When not watching TV, turn off the 4250 to help conserve energy
- 2 VOL-, VOL+** Decreases and increases volume
- 3 CH+, CH-** Scrolls up and down through the channels
- 4 SELECT** Accesses your on-screen selection
- 5 IR Sensor** Receives the infrared signal from the remote control
- 6 LED Display** Displays the selected channel number and time of day. The LED also displays the following:
 - Message ()
 - Power ()
- 7 GUIDE** Accesses on-screen services, such as the on-screen guide, video-on-demand, or pay-per-view
- 8 INFO** Displays a description of the selected program. Available from the on-screen guide and while viewing a program
- 9 EXIT** Exits menus, on-screen guide, and program information
- 10 SETTINGS** Displays the Settings Menu
- 11 Smart Card Slot** Allows Smart Card access
- 12 USB Port** Connects to external equipment, such as a keyboard

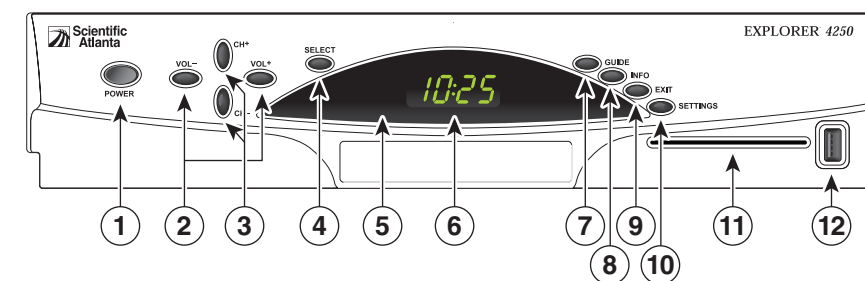

Safety and Performance Tips

- Keep the top of the 4250 free of all objects and electronic devices, including your TV
- Always set the 4250 on its feet, never on its side

Back Panel Connectors

- 1 CABLE IN** Connects to the coaxial cable that delivers the signal from your cable service provider
- 2 CABLE OUT** Connects to a coaxial cable to send analog audio and video signals to a TV or VCR. These signals are standard-definition TV (SDTV) video and stereo audio
- 3 AUDIO OUT (L/R)** Connects to left/right (L/R) audio inputs of TV or A/V receiver
- 4 Digital Audio Out** Connects to the RCA cable to send a digital audio signal to a surround-sound receiver or other digital audio device
- 5 VIDEO OUT** Connects to video input of TV or VCR (standard-definition)
- 6 S-VIDEO OUT** Connects to S-Video input of a standard TV or VCR
- 7 IR Port** Connects to optional VCR Commander™ service (May not be available on all 4250 models)
- 8 USB Port** Connects to external equipment, such as a keyboard (May not be available on all 4250 models)
- 9 AC Switched Outlet** Connects the AC power cord from another device, such as a TV
- 10 AC Power Input** Connects the 4250 to an AC electrical outlet using the cord provided

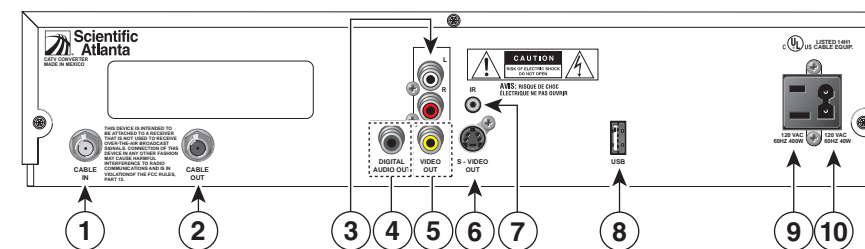

Before Installing and Using the 4250

1. Unplug all electronic devices before connecting the 4250.
2. Connect the 4250 to the TV as shown in the diagram.
3. Connect the 4250 to the coaxial cable coming from the wall.
4. Plug the 4250 and the TV into an AC power source.
Important: Do *not* press the Power key on the 4250 yet.
5. Turn on the power to your TV, and set the input channel assigned by your cable service provider (channel 3 or 4).
6. Wait for the time to display on the LED display. **Important:** It takes 2 to 3 minutes for the 4250 to be updated with the latest programming and service information. When the front panel displays the time, the update is complete.

Access Cable Services and Programs

Access cable services and programs by pressing the following keys on the remote control:

- **Guide**— Access the on-screen guide for schedules of TV programs and other services available from your cable service provider, such as video-on-demand and pay-per-view programs.
- **Arrows**—Highlight a program in the schedule.
- **INFO**—Display a specific program description (either from the on-screen guide or while viewing a program).
- **SELECT**—View a specific program in the guide.

Avoid Screen Burn-In

Images such as letterbox bars or side bars, bright closed-captioning backgrounds, station logos, or any other stationary images may cause the HDTV screen to age unevenly and cause damage to your HDTV.

Refer to the user's guide that came with your HDTV for more information about screen burn-in.

Automatic Software Updates

The TV screen displays a message that indicates the 4250 is automatically updating its software.

Wait for the current time to appear on the front panel of the 4250 before continuing. When the time appears, the update is complete.

Note: If you need further assistance, contact your cable service provider.

Performance Tips

If the 4250 does not perform as expected, the following tips may help.

No picture

- Verify that the power to your TV is turned on.
- If the 4250 is plugged into a wall switch, verify the switch is in the ON position. (Avoid plugging into a switched outlet.)
- Verify that all cables are properly connected.
- The current channel may not be available in your service package. Try selecting another channel to see if video is available.

No color

- Verify the current TV program is broadcast in color.
- Adjust the TV color controls.

No sound

- If your setup includes a VCR or stereo, verify that you have properly connected them to the 4250.
- Verify the volume is turned up.
- Verify the mute function is not on.

Connecting the 4250 to a Stereo TV and Stereo VCR

Use the connection diagram and follow these steps to connect the 4250 to a stereo TV and a non-stereo VCR.

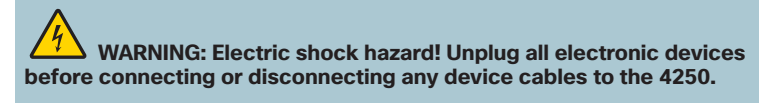

1. Connect the 4250 to the TV and VCR as shown in the diagram.
2. Connect the 4250 to the coaxial cable coming from the wall.
3. Plug the 4250 and the TV into an AC power source.
Important: Do *not* press the Power key on the 4250 yet.
4. Wait for the time to appear on the LED display.
Important: It takes 2 to 3 minutes for the 4250 to be updated with the latest programming and service information. When the front panel displays the time, the update is complete.
5. Press the **Power** key on the 4250.
6. Turn on the power to your TV, and set the input channel assigned by your cable service provider (channel 3 or 4).

Explorer 4250

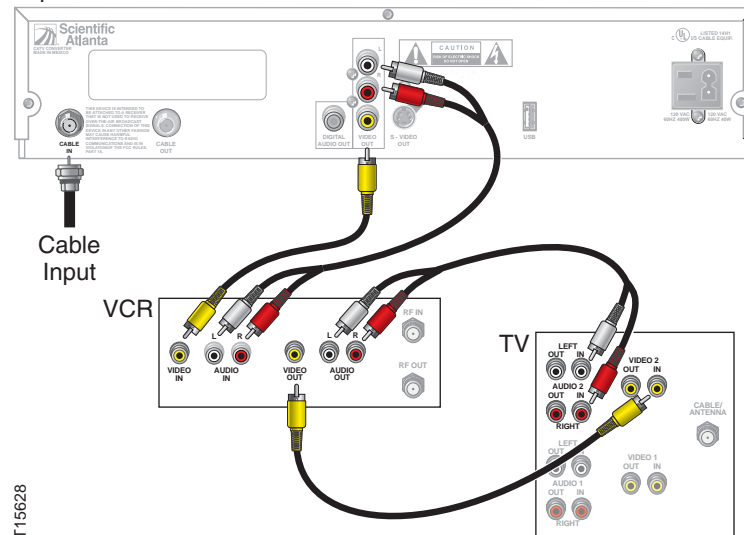

T15628

IMPORTANT SAFETY INSTRUCTIONS

Notice to Installers

The servicing instructions in this notice are for use by qualified service personnel only. To reduce the risk of electric shock, do not perform any servicing other than that contained in the operating instructions, unless you are qualified to do so.

Note to System Installer

For this apparatus, the coaxial cable shield/screen shall be grounded as close as practical to the point of entry of the cable into the building. For products sold in the US and Canada, this reminder is provided to call the system installer's attention to Article 820-93 and Article 820-100 of the NEC (or Canadian Electrical Code Part 1), which provides guidelines for proper grounding of the coaxial cable shield.

CAUTION
RISK OF ELECTRIC SHOCK
DO NOT OPEN

AVIS
RISQUE DE CHOC ÉLECTRIQUE
NE PAS OUVRIR

CAUTION: To reduce the risk of electric shock, do not remove cover (or back). No user-serviceable parts inside. Refer servicing to qualified service personnel.

WARNING
TO PREVENT FIRE OR ELECTRIC SHOCK, DO NOT EXPOSE THIS UNIT TO RAIN OR MOISTURE.

This symbol is intended to alert you that uninsulated voltage within this product may have sufficient magnitude to cause electric shock. Therefore, it is dangerous to make any kind of contact with any inside part of this product.

Ce symbole a pour but d'alerter toute personne qu'un contact avec une pièce interne de ce produit, sous tension et non isolée, pourrait être suffisant pour provoquer un choc électrique. Il est donc dangereux d'être en contact avec toute pièce interne de ce produit.

This symbol is intended to alert you of the presence of important operating and maintenance (servicing) instructions in the literature accompanying this product.

Ce symbole a pour but de vous avertir qu'une documentation importante sur le fonctionnement et l'entretien accompagne ce produit.

20070131 SysInstaller 820 US/Canada/Int

Read These Instructions

Keep These Instructions

Heed All Warnings

Follow All Instructions

Power Source Warning

A label on this product indicates the correct power source for this product. Operate this product only from an electrical outlet with the voltage and frequency indicated on the product label. If you are uncertain of the type of power supply to your home or business, consult your service provider or your local power company.

The AC inlet on the unit must remain accessible and operable at all times.

Ground the Product



WARNING: Avoid electric shock and fire hazard! Do not defeat the safety purpose of the polarized or grounding-type plug. A polarized plug has two blades with one wider than the other. A grounding-type plug has two blades and a third grounding prong. The wide blade or the third prong is provided for your safety. If the provided plug does not fit into your outlet, consult an electrician for replacement of the obsolete outlet.

If this product connects to coaxial cable wiring, be sure the cable system is grounded (earthed). Grounding provides some protection against voltage surges and built-up static charges.

Outdoor Grounding System

If this product connects to an outdoor antenna or cable system, be sure the antenna or cable system is grounded (earthed). This provides some protection against voltage surges and built-up static charges.

Article 810 of the National Electric Code (NEC) ANSI/NFPA No. 70-1990, provides the following information:

- Grounding of the mast and supporting structure
- Grounding the lead-in wire to an antenna discharge unit
- Size of the grounding conductors
- Location of the antenna-discharge unit
- Connection to grounding electrodes
- Requirements for the grounding electrodes (see the following antenna grounding diagram as recommended by NEC ANSI/NFPA 70)



WARNING: Avoid electric shock and fire hazard! Do not locate an outside antenna system in the vicinity of overhead power lines or power circuits. Touching power lines or circuits might be fatal.

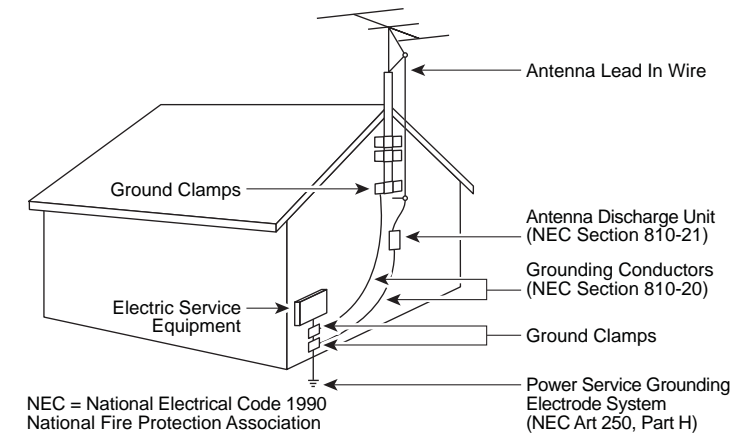

NEC = National Electrical Code 1990
National Fire Protection Association

TO CATV INSTALLER
This reminder is provided to call the CATV system installer's attention to Article 820-40 of the National Electrical Code (NEC) that provides guidelines for proper grounding, and in particular, specifies that the cable ground shall be connected to the grounding system of the building, as close to the point of entry as practical.

Protect the Product from Lightning

For added protection, unplug this apparatus during lightning storms or when unused for long periods of time. In addition to disconnecting the AC power from the wall outlet, disconnect the signal inputs.

Verify the Power Source from the On/Off Power Light

When the on/off power light is not illuminated, the apparatus may still be connected to the power source. The light goes out when the apparatus is turned off, regardless of whether it is still plugged into an AC power source.

Eliminate AC Power/Mains Overloads



WARNING: Avoid electric shock and fire hazard! Do not overload AC power/mains, outlets, extension cords, or integral convenience receptacles. For products that require battery power or other power sources to operate them, refer to the operating instructions for those products.

Prevent Power Cord Damage

Protect the power cord from being walked on or pinched, particularly at plugs, convenience receptacles, and the point where the cord exits from the apparatus.

Provide Ventilation and Select a Location

- Do not block any ventilation openings. Install in accordance with the manufacturer's instructions.
- Do not place this apparatus on a bed, sofa, rug, or similar surface.
- Do not place this apparatus on an unstable surface.
- Do not install near any heat sources such as radiators, heat registers, stoves, or other apparatus (including amplifiers) that produce heat.
- Do not install this apparatus in an enclosure, such as a bookcase or rack, unless the installation provides proper ventilation.
- Do not place entertainment devices (such as VCRs or DVDs), lamps, books, vases with liquids, or other objects on top of this product.

Operating Environment

This product is designed for operation indoors with a temperature range from 32° to 104° F (0° to 40° C). Each product should have adequate spacing on all sides so that the cooling air vents on the chassis are not blocked.

Protect from Exposure to Moisture and Foreign Objects

Do not use this apparatus near water.



WARNING: Avoid electric shock and fire hazard! Do not expose this product to liquids, rain, or moisture.



WARNING: Avoid electric shock and fire hazard! Unplug this product before cleaning. Clean only with a dry cloth. Do not use a liquid cleaner or an aerosol cleaner. Do not use a magnetic/static cleaning device (dust remover) to clean this product.



WARNING: Avoid electric shock and fire hazard! Never push objects through the openings in this product. Foreign objects can cause electrical shorts that can result in electric shock or fire.

T15332